

# Accessories

## Modular bus covers

### CANopen®

#### Shaft / end shaft encoders



#### View inside bus cover

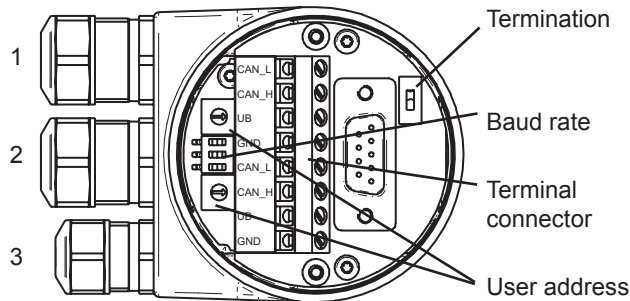

Cable: 1, 2 =  $\varnothing$ 8-10 mm (-40-85 °C) /  $\varnothing$ 5-9 mm (-25-85 °C)  
 Cable: 3 =  $\varnothing$ 4.5-6 mm (-40-85 °C) /  $\varnothing$ 3-6 mm (-25-85 °C)

#### Features - CANopen®

Bus protocol	CANopen®
Device profile	CANopen® - CiA DSP 406, V 3.0 (Device Class 2, CAN 2.0B)
Operating mode	Event-triggered Time-triggered Remotely-requested Sync (cyclic) Sync (acyclic)
Preset	Parameter for setting the encoder to a requested position value assigned to a defined shaft position of the system. The offset of encoder zero point and mechanical zero point is stored in the encoder.
Rotating direction	Parameter for defining the rotating direction in which there have to be ascending or descending position values.
Scaling	Parameter defining the steps per turn as well as the total resolution.
Diagnosis	The encoder supports the following error warnings: - Position and parameter error - Lithium battery voltage control (Multiturn)
Node ID monitoring	Heartbeat or Nodeguarding
Default	50 kbit/s, Node ID 1

#### Part number

<b>Z 163.5P32</b>	CANopen/Cable gland
<b>Z 163.5PA2</b>	CANopen/Connector M12
<b>10140832</b>	CANopen/Cable gland
<b>10147370</b>	CANopen/Cable gland in stainless steel V2A without DUO-LED
<b>10167265</b>	CANopen/Connector M12
<b>10167266</b>	CANopen/Connector M12 in stainless steel V2A without DUO-LED
<b>11048898</b>	CANopen/ATEX cable gland

#### Bus cover

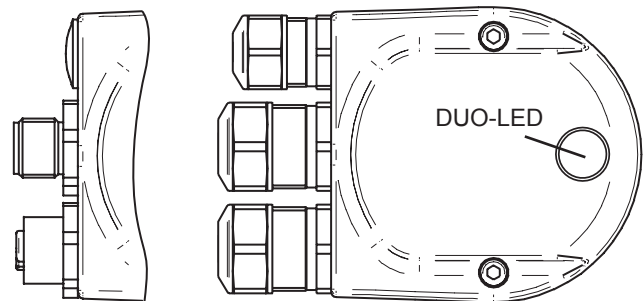

Connector M12 Cable gland

#### Terminal assignment

Pin 1	GND	Ground connection relating to UB
Pin 2	UB	Voltage supply 10...30 VDC
Pin 3	–	–
Pin 4	CAN_H	CAN bus signal (dominant High)
Pin 5	CAN_L	CAN bus signal (dominant Low)

Terminals of the same significance are internally connected and identical in their functions. Max. load on the internal terminal connections UB-UB and GND-GND is 1 A each.

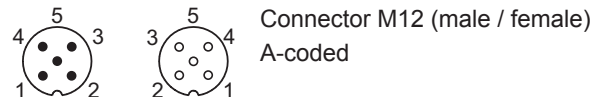

#### Termination

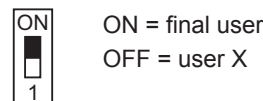

ON = final user  
 OFF = user X

#### User address (identifier)

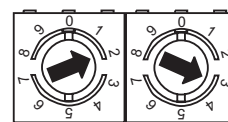

Defined by rotary switch.  
 Example: User address 23

#### Baud rate



Baud rate	Dip switch position		
	1	2	3
10 kbit/s	OFF	OFF	OFF
20 kbit/s	OFF	OFF	ON
50 kbit/s	OFF	ON	OFF
125 kbit/s	OFF	ON	ON
250 kbit/s	ON	OFF	OFF
500 kbit/s	ON	OFF	ON
800 kbit/s	ON	ON	OFF
1 MBit/s	ON	ON	ON

If the user address is 00 the baud rate and Node ID are programmable via CAN bus.

# Accessories

## Modular bus covers

### DeviceNet



## Shaft / end shaft encoders

### View inside bus cover

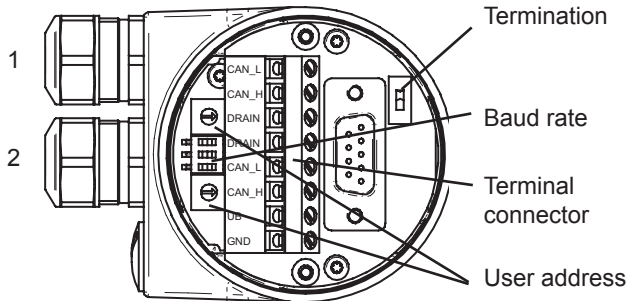

Cable: 1, 2 = ø8-10 mm (-40-85 °C) / ø5-9 mm (-25-85 °C)

### Bus cover

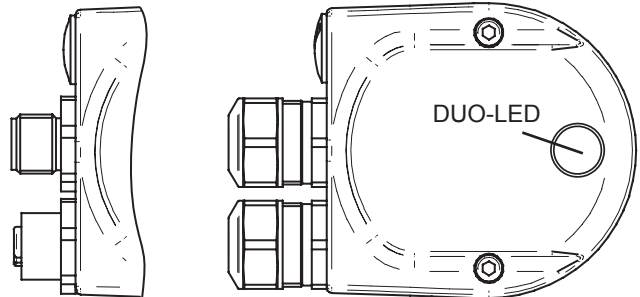

Connector M12

Cable gland

### Features - DeviceNet

Bus protocol	DeviceNet
Device profile	Device Profile for Encoders V 1.0
Operating modes	I/O-Polling Cyclic Change of State
Preset	Parameter for setting the encoder to a requested position value assigned to a defined shaft position of the system. The offset of encoder zero point and mechanical zero point is stored in the encoder.
Rotating direction	Parameter for defining the rotating direction in which there have to be ascending or descending position values.
Scaling	Parameter defining the steps per turn as well as the total resolution.
Diagnosis	The encoder supports the following error warnings: - Position and parameter error - Lithium battery voltage control (Multiturn)
Default	125 kbit/s, Mac ID 63

### Terminal assignment

Pin 1	DRAIN	Shield
Pin 2	UB	Voltage supply 10...30 VDC
Pin 3	GND	Ground connection relating to UB
Pin 4	CAN_H	CAN bus signal (dominant High)
Pin 5	CAN_L	CAN bus signal (dominant Low)

Terminals of the same significance are internally connected and identical in their functions. Max. load on the internal terminal connections UB-UB and GND-GND is 1 A each.

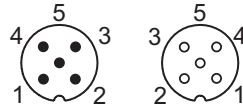

Connector M12 (male / female), A-coded

### Termination

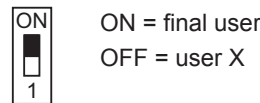

### User address (identifier)

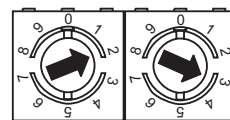

Defined by rotary switch.  
Example: User address 23

### Part number

<b>Z 163.8P22</b>	DeviceNet/Cable gland
<b>Z 163.8PA2</b>	DeviceNet/Connector M12
<b>10140833</b>	DeviceNet/Cable gland
<b>10147371</b>	DeviceNet/Cable gland in stainless steel V2A without DUO-LED
<b>10167269</b>	DeviceNet/Connector M12
<b>10167273</b>	DeviceNet/Connector M12 in stainless steel V2A without DUO-LED

### Baud rate

	Baud rate	Dip switch position		
		1	2	3
	125 kBit/s	X	OFF	OFF
	250 kBit/s	X	OFF	ON
	500 kBit/s	X	ON	OFF
	125 kBit/s*	X	ON	ON

X = w/o function

\* = This switch position is not defined, therefore internally set to default 125 kBit/s.

# Accessories

## Modular bus covers

### Profibus-DPV0



## Shaft / end shaft encoders

### View inside bus cover

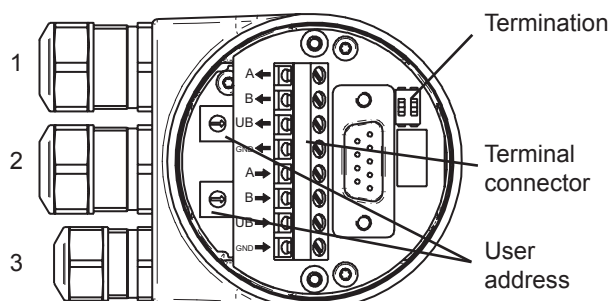

Cable: 1, 2 =  $\varnothing$ 8-10 mm (-40-85 °C) /  $\varnothing$ 5-9 mm (-25-85 °C)  
 Cable: 3 =  $\varnothing$ 4.5-6 mm (-40-85 °C) /  $\varnothing$ 3-6 mm (-25-85 °C)

### Features - Profibus-DPV0

Bus protocol	Profibus-DPV0
Device profile	Device Class 1 and 2
Cyclic data exchange	Communication in line with DPV0
Input data	Position value. In addition optionally speed signal parametering (output of current rotation speed).
Output data	Preset
Preset	Parameter for setting the encoder to a requested position value assigned to a defined shaft position of the system. Storage non-volatile.
Rotating direction	Parameter for defining the rotating direction in which there have to be ascending or descending position values.
Scaling	Parameter defining the steps per turn as well as the total resolution.
Diagnosis	The encoder supports the following error warnings: - Position and parameter error - Lithium battery voltage control (Multiturn)
Default	User address 00 Termination OFF

### Part number

<b>Z 163.3P32</b>	Profibus-DPV0/Cable gland
<b>Z 163.3PA2</b>	Profibus-DPV0/Connector M12
<b>10140831</b>	Profibus-DPV0/Cable gland
<b>10147369</b>	Profibus-DPV0/Cable gland stainless steel V2A without DUO-LED
<b>10167254</b>	Profibus-DPV0/Connector M12
<b>10167256</b>	Profibus-DPV0/Connector M12 stainless steel V2A without DUO-LED
<b>11048897</b>	Profibus-DPV0/ATEX cable gland

### Bus cover

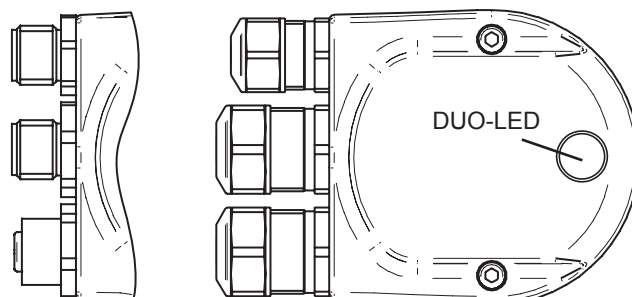

Connector M12 Cable gland

### Terminal assignment

#### Connector M12 (male), A-coded

Pin 1	UB	Voltage supply 10...30 VDC
Pin 3	GND	Ground connection relating to UB



#### Connector M12 (male / female), B-coded

Pin 2	A	Negative data line
Pin 4	B	Positive data line

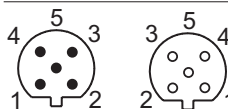

Terminals of the same significance are internally connected and identical in their functions. Max. load on the internal terminal connections UB-UB and GND-GND is 1 A each.

### Termination

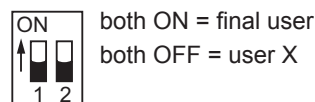

### User address (identifier)

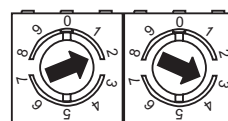

Defined by rotary switch.  
 Example: User address 23

# Accessories

## Modular bus covers

### Profibus-DPV2



## Shaft / end shaft encoders

### View inside bus cover

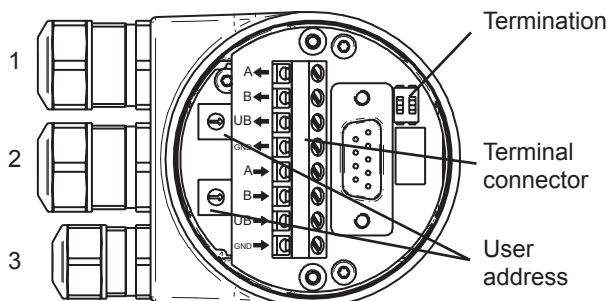

Cable: 1, 2 =  $\varnothing$ 8-10 mm (-40-85 °C) /  $\varnothing$ 5-9 mm (-25-85 °C)  
 Cable: 3 =  $\varnothing$ 4.5-6 mm (-40-85 °C) /  $\varnothing$ 3-6 mm (-25-85 °C)

### Features - Profibus-DPV2

Bus protocol	Profibus-DPV2
Device profile	Device Class 3 and 4
Cyclic data exchange	Communication by synchronous clock (IsoM) in line with DPV2 DXB (cross traffic): publisher function
Acyclic data exchange	I&M (Identification and Maintenance) Functions
Input data	Position value. In addition optionally speed signal parametering (output of current rotation speed).
Output data	Preset
Preset	Parameter for setting the encoder to a requested position value assigned to a defined shaft position of the system. Storage non-volatile.
Rotating direction	Parameter for defining the rotating direction in which there have to be ascending or descending position values.
Scaling	Parameter defining the steps per turn as well as the total resolution.
Diagnosis	The encoder supports the following error warnings: - Position and parameter error - Lithium battery voltage control (Multiturn)
Default	User address 00 Termination OFF

### Part number

<b>Z 163.3V32</b>	Profibus-DPV2/Cable gland
<b>Z 163.3VA2</b>	Profibus-DPV2/Connector M12
<b>10167260</b>	Profibus-DPV2/Cable gland
<b>10167262</b>	Profibus-DPV2/Cable gland stainless steel V2A without DUO-LED
<b>10167281</b>	Profibus-DPV2/Connector M12
<b>10167263</b>	Profibus-DPV2/Connector M12 stainless steel V2A without DUO-LED

### Bus cover

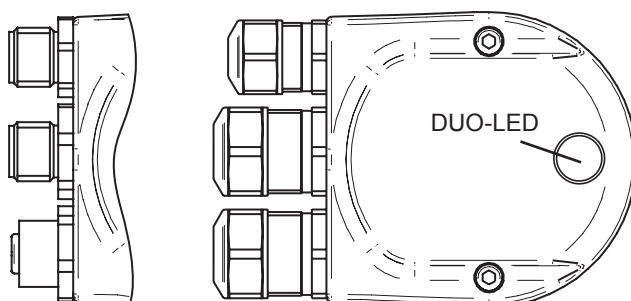

Connector M12 Cable gland

### Terminal assignment

#### Connector M12 (male), A-coded

Pin 1	UB	Voltage supply 10...30 VDC
Pin 3	GND	Ground connection relating to UB



#### Connector M12 (male / female), B-coded

Pin 2	A	Negative data line
Pin 4	B	Positive data line

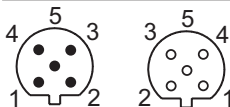

Terminals of the same significance are internally connected and identical in their functions. Max. load on the internal terminal connections UB-UB and GND-GND is 1 A each.

### Termination



both ON = final user  
 both OFF = user X

### User address (identifier)

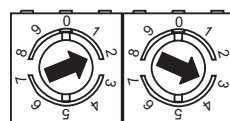

Defined by rotary switch.  
 Example: User address 23

# Accessories

## Modular bus covers

### EtherCAT

#### Shaft / end shaft encoders



#### View inside bus cover

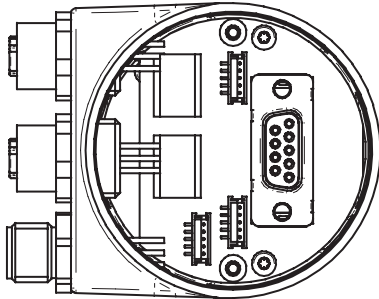

#### Bus cover

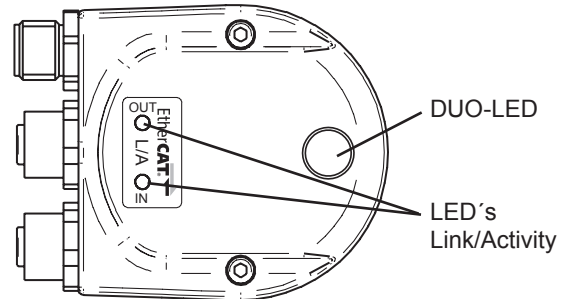

#### Features - EtherCAT

Bus protocol	EtherCAT
Device profile	CoE (CANopen over EtherCAT) DSP406
Features	<ul style="list-style-type: none"> <li>- 100 MBaud Ethernet</li> <li>- Automatic address designation</li> <li>- Distributed clock for precise synchronization. Optional device configuration as „Reference Clock“</li> <li>- Default 10 byte PDO, configurable 4 byte PDO / 2 byte PDO for shorter cycle times</li> </ul>
Process data	Position value Warnings System time
Cycle times	Depending on sensor type, enabled scaling functionality and length of PDO. Min. cycle time: 62,5 µs
Synchronization	0x00 Free Run, not synchronized 0x03 Distributed clocks DC, synchronized with SYNCO/SYNC1 Event

#### Part number

**Z 163.EPA6** Bus cover EtherCAT

#### Terminal assignment

##### Voltage supply

Terminal	Assigned	Significance
Pin 1	UB	Voltage supply
Pin 2	N.C.	Not assigned
Pin 3	GND	Ground
Pin 4	N.C.	Not assigned

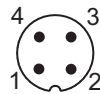

1 x Connector M12 (male), A-coded

##### EtherCAT (data line)

Terminal	Assigned	Significance
Pin 1	TxD+	Transmission data+
Pin 2	RxD+	Receiving data+
Pin 3	TxD-	Transmission data-
Pin 4	RxD-	Receiving data-

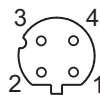

2 x Connector M12 (female), D-coded

#### Accessories

<b>Z 185.E05</b>	Connector M12, on both sides, CuZn nickel-plated/TPU, 5 m cable PUR (data line)
<b>Z 185.P05</b>	Connector M12, CuZn nickel-plated/TPU, 5 m cable PUR, 360° screen (voltage supply)

# Accessories

## Modular bus covers

### PoE - Power over EtherCAT

#### Shaft / end shaft encoders

##### View inside bus cover

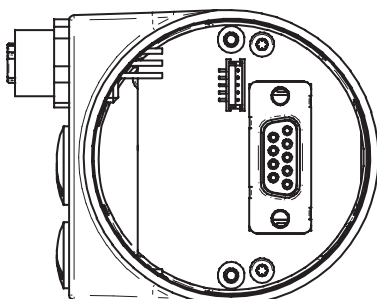

##### Bus cover

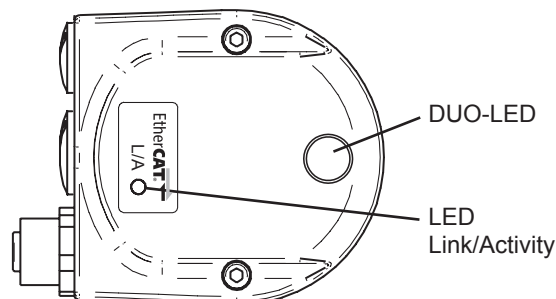

##### Features - Power over EtherCAT

Bus protocol	EtherCAT
Device profile	CoE (CANopen over EtherCAT) DSP406
Features	<ul style="list-style-type: none"> <li>- 100 MBaud Ethernet</li> <li>- Automatic address designation</li> <li>- Distributed clock for precise synchronization. Optional device configuration as „Reference Clock“</li> <li>- Default 10 byte PDO, configurable 4 byte PDO / 2 byte PDO for shorter cycle times</li> </ul>
Process data	Position value Warnings System time
Cycle times	Depending on sensor type, enabled scaling functionality and length of PDO. Min. cycle time: 62,5 µs
Synchronization	0x00 Free Run, not synchronized 0x03 Distributed clocks DC, synchronized with SYNCO/SYNC1 Event
Function PoE	Compliant to standard IEEE Std 802.3af
Excess temperature	Protection against excess temperature
PoE mains unit	Galvanically insulated
Hot-Connect	Connecting/disconnecting the device during operation

##### Technical data - Power over EtherCAT

Capacity class	1 (max. 4 W)
Supply voltage	44...57 VDC
Current consumption	≤50 mA (48 VDC)
Cable length	Max. 100 m

##### Part number

**Z 163.EEA2** Bus cover PoE - Power over EtherCAT

##### Terminal assignment

Terminal	Assigned	Significance
Pin 1	TxD+	Transmission data+
Pin 2	RxD+	Receiving data+
Pin 3	TxD-	Transmission data-
Pin 4	RxD-	Receiving data-



2 x Connector M12 (female), D-coded

Power supply of PSE module (Power Sourcing Equipment) is also by these lines.

##### Accessories

**Z 185.E05** Ethernet cable, connector M12 on both sides with 5 m cable

# Accessories

## Modular bus covers

### Lightbus

#### Shaft / end shaft encoders

## LIGHTBUS

#### View inside bus cover

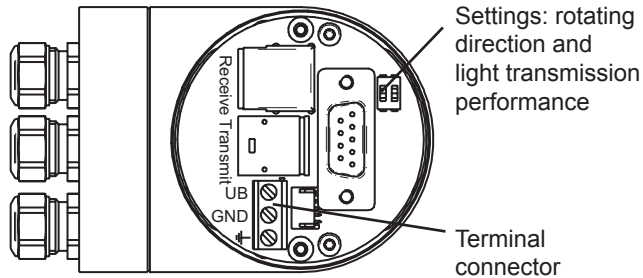

#### Bus cover

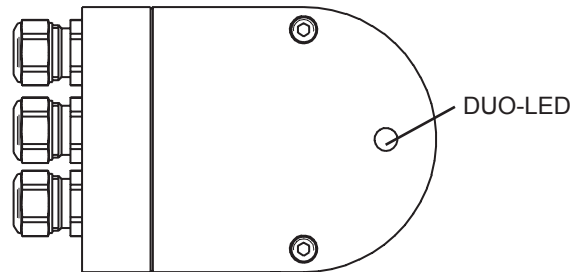

#### Features - Lightbus

Bus protocol	Beckhoff
Diagnosis	The encoder supports the following error warnings: - Lithium battery voltage control (Multiturn), transferred as MSB in the 32 bit data word
Transmission rate	Lightbus max. 2.5 Mbaud
Electro-magnetic interference	Lightbus busses are immune against all kinds of electromagnetic interferences and can be applied without considering eventual sources of EMC emission.
Connection	Lightbus transmitter and receiver

#### Part number

**Z 163.LM32** Bus cover Lightbus

#### Terminal assignment

UB	Voltage supply 10...30 VDC
GND	Ground connection relating to UB
⊥	Housing

#### Settings - Lightbus



Switch 1: Definition of rotating direction  
ON: R (CCW) descending code\*  
OFF: V (CW) ascending code\*

Switch 2: Light transmission performance  
ON: Increased light transmission (30...50 m)  
OFF: Standard light transmission (up to 30 m)

\* With clockwise shaft rotation when looking at flange.

#### Accessories

**Z 119.034** Lightbus connector for data cable

Recommended cable for fibre-optic lines:  
LAPP Kabel, Stuttgart, Art.: 2185030  
HITRONIC® POF SIMPLEX PUR-PE

# Accessories

## Modular bus covers

### SSI



## Shaft / end shaft encoders

### View inside bus cover

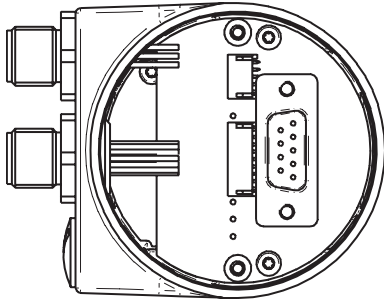

### Bus cover

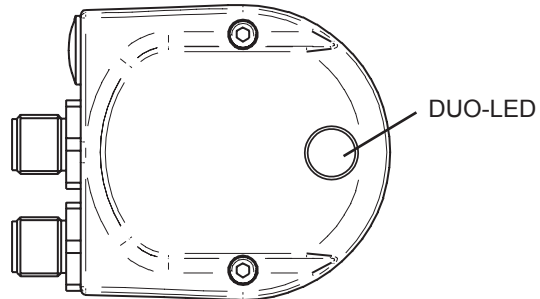

### Features - SSI

Bus protocol	SSI (Synchronous Serial Interface)
Preset	Parameter for setting the encoder to a requested position value assigned to a defined shaft position of the system. The offset of encoder zero point and mechanical zero point is stored in the encoder.
Rotating direction	Parameter for defining the rotating direction in which there have to be ascending or descending position values.
Scaling	Parameter defining the steps per turn as well as the total resolution.
Diagnosis	The encoder supports the following error warnings: - Position and parameter error - Lithium battery voltage control (Multiturn)
Parameters	Programmable by ProGeber software
SSI clock frequency	62.5 kHz...1.0 MHz
Monoflop time	15...50 µs (Default: 20 µs)
Clock interval	Min. 180 µs
Voltage supply	10...30 VDC
Output	RS485 driver
Status LED	Green: operational Yellow (red/green on): warning of the lithium battery charge condition Red (2.5 s on): position error

### Part number

**Z 163.2PA2** Bus cover SSI

### Terminal assignment

Terminal	Assigned 5-pin connector*	8-pin connector / colour
Pin 1	UB	Clock+ / white
Pin 2	RxD	Clock- / brown
Pin 3	GND-PRG	Data+ / green
Pin 4	GND B	Data- / yellow
Pin 5	TxD	Preset / grey
Pin 6	-	UP/DOWN / pink
Pin 7	-	GND B / blue
Pin 8	-	UB / red

\* programming interface

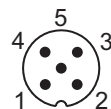

5-pin connector, A-coding

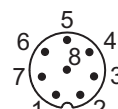

8-pin connector, A-coding

Recommendation: use pairs of twisted wires with extension cables.

### Accessories

<b>Z 139.008</b>	Programming cable for encoders with SSI bus cover, CD with software and manual
<b>Z 174.003</b>	Connector M12, 8-pin with 2 m cable
<b>Z 174.005</b>	Connector M12, 8-pin with 5 m cable

# Accessories

## Modular bus covers

### PROFINET



## Shaft / end shaft encoders

### View inside bus cover

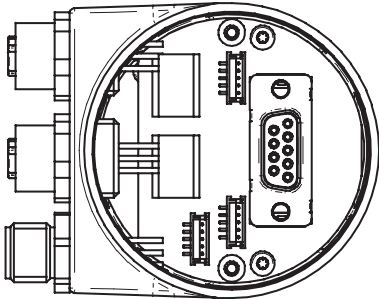

### Bus cover

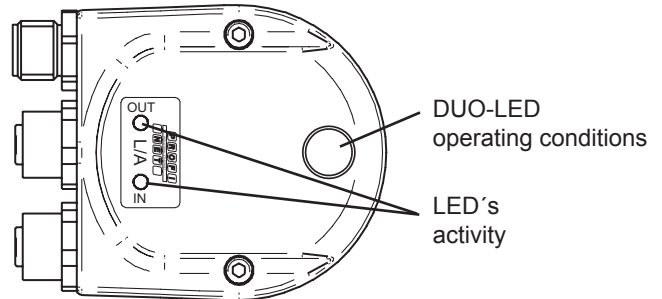

### Features - PROFINET

Bus protocol	PROFINET
Device profile	Encoder Profile PNO 3.162
Features	- 100 MBaud Fast Ethernet - Automatic address designation - Realtime (RT) Class 1, IRT Class 2, IRT Class 3
Process data	Position value 32 bit input data

### Part number

**Z 163.3EA2** Bus cover PROFINET

### Terminal assignment

#### Voltage supply

Terminal	Assigned	Significance
Pin 1	UB	Voltage supply
Pin 2	N.C.	Not assigned
Pin 3	GND	Ground
Pin 4	N.C.	Not assigned

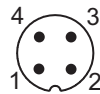

1 x Connector M12 (male), A-coded

#### PROFINET (data line)

Terminal	Assigned	Significance
Pin 1	TxD+	Transmission data+
Pin 2	RxD+	Receiving data+
Pin 3	TxD-	Transmission data-
Pin 4	RxD-	Receiving data-

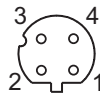

2 x Connector M12 (female), D-coded

### Accessories

<b>Z 185.E05</b>	Ethernet cable, connector M12 on both sides with 5 m cable (data line)
<b>Z 185.P05</b>	Connector M12 with 5 m cable, 360° screen (current line)

# Accessories

## Modular bus covers

### EtherNet/IP



## Shaft / end shaft encoders

### View inside bus cover

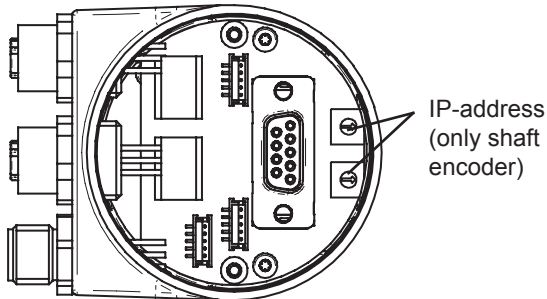

### Bus cover

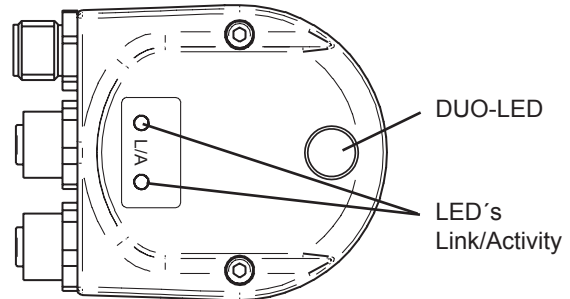

### Features - EtherNet/IP

Bus protocol	EtherNet/IP
Device profile	Encoder Device, type 22hex, according to CIP specification
Features	<ul style="list-style-type: none"> <li>- 100 MBaud Fast Ethernet</li> <li>- IP address programmable</li> <li>- Automatic IP address designation (DHCP)</li> <li>- Rotation direction, resolution, total resolution and preset are programmable according to CIP specification</li> </ul>
Process data	Position value, Warning Flag, Alarmflag Assembly Instances 1 and 2 according to CIP specification

### Part number

**Z 163.8EA2** Bus cover EtherNet/IP

### Terminal assignment

#### Voltage supply

Terminal	Assigned	Significance
Pin 1	UB	Voltage supply
Pin 2	N.C.	Not assigned
Pin 3	GND	Ground
Pin 4	N.C.	Not assigned

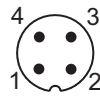

1 x Connector M12 (male), A-coded

#### EtherNet/IP (data line)

Terminal	Assigned	Significance
Pin 1	TxD+	Transmission data+
Pin 2	RxD+	Receiving data+
Pin 3	TxD-	Transmission data-
Pin 4	RxD-	Receiving data-

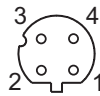

2 x Connector M12 (female), D-coded

### IP address

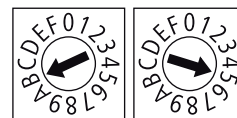

Defined by HEX rotary switch  
Example: IP address B5<sub>hex</sub>  
Configuration via DHCP: 00<sub>hex</sub>

### Accessories

<b>Z 185.E05</b>	Ethernet cable, connector M12 on both sides with 5 m cable (data line)
<b>Z 185.P05</b>	Connector M12 with 5 m cable, 360° screen (current line)

# Accessories

## Modular bus covers

### POWERLINK

ETHERNET   
**POWERLINK**

## Shaft / end shaft encoders

### View inside bus cover

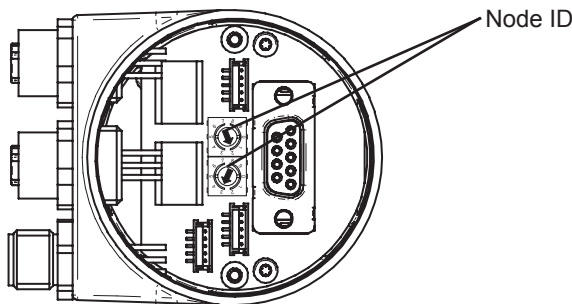

### Bus cover

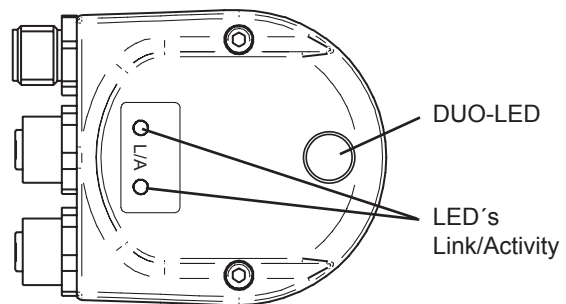

### Features - POWERLINK

Bus protocol	Ethernet Powerlink 2.0
Device profile	DSP406
Address	Free configurable via software or rotary switch Standard node 1 Standard IP 192.168.100.1
Features	<ul style="list-style-type: none"> <li>- 100 MBaud Ethernet</li> <li>- Response times &lt;2 μs</li> <li>- Cycle times &lt;200 μs</li> <li>- Jitter from Start of Cycle (SoC) to position detection &lt;200 ns</li> <li>- Daisy Chain is possible</li> <li>- Rotation direction, resolution, total resolution and preset are programmable</li> </ul>
Process data	Position value

### Part number

**Z 163.5EA2** Bus cover POWERLINK

### Accessories

<b>Z 185.E05</b>	Ethernet cable, connector M12 on both sides with 5 m cable (data line)
<b>Z 185.P05</b>	Connector M12 with 5 m cable, 360° screen (current line)
<b>133852</b>	Connector M12 straight with 2 m cable, (current line)
<b>133853</b>	Connector M12 straight with 5 m cable, (current line)
<b>135247</b>	Connector M12 straight with 10 m cable, (current line)
<b>160565</b>	Ethernet cable, connector M12 on both sides with 5 m cable (data line)

### Terminal assignment

#### Voltage supply

Terminal	Assigned	Significance
Pin 1	UB	Voltage supply
Pin 2	N.C.	Not assigned
Pin 3	GND	Ground
Pin 4	N.C.	Not assigned

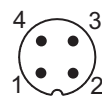

1 x Connector M12 (male), A-coded

#### POWERLINK (data line)

Terminal	Assigned	Significance
Pin 1	TxD+	Transmission data+
Pin 2	RxD+	Receiving data+
Pin 3	TxD-	Transmission data-
Pin 4	RxD-	Receiving data-

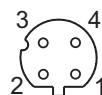

2 x Connector M12 (female), D-coded

### Node ID

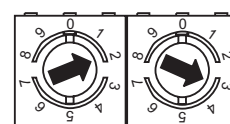

Defined by rotary switch.  
Example: User address 23.  
If the rotary switch 00 the Node ID are programmable via bus.

# Accessories

## Modular bus covers

### SAEJ1939

#### Shaft / end shaft encoders

SAEJ1939

#### View inside bus cover

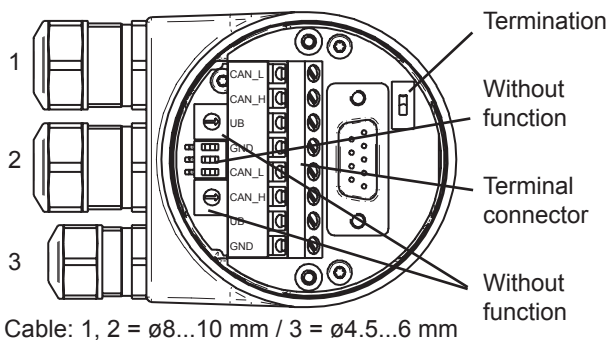

Cable: 1, 2 =  $\varnothing 8 \dots 10$  mm / 3 =  $\varnothing 4.5 \dots 6$  mm

#### Bus cover

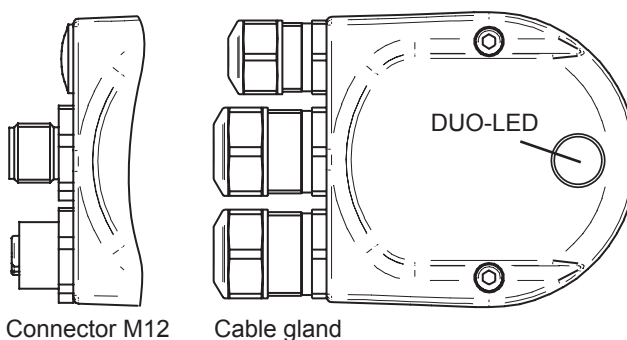

Connector M12

Cable gland

#### Features - SAE J1939

Bus protocol	SAE J1939
Device profile	Industry Group 5, Industrial, Process control
Operating mode	Time-triggered, On Request
Preset	Parameter for setting the encoder to a requested position value assigned to a defined shaft position of the system. The offset of encoder zero point and mechanical zero point is stored in the encoder.
Rotating direction	Parameter for defining the rotating direction in which there have to be ascending or descending position values.
Scaling	Parameter defining the steps per turn as well as the total resolution.
Diagnosis	The encoder supports the following error warnings: - Position and parameter error - Lithium battery voltage control (Multiturn)
Node ID monitoring	Heartbeat or Nodeguarding
Cycle time	Repetition rate for data: position, speed, diagnostic

#### Part number

<b>Z 163.5B32</b>	SAEJ1939/Cable gland
<b>Z 163.5BA2</b>	SAEJ1939/Connector M12

#### Terminal assignment

Pin 1	GND	Ground connection relating to UB
Pin 2	UB	Voltage supply 10...30 VDC
Pin 3	–	–
Pin 4	CAN_H	CAN bus signal (dominant High)
Pin 5	CAN_L	CAN bus signal (dominant Low)

Terminals of the same significance are internally connected and identical in their functions. Max. load on the internal terminal connections UB-UB and GND-GND is 1 A each.

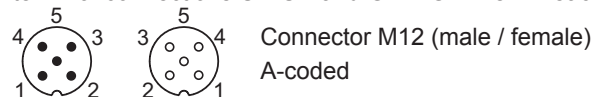

Connector M12 (male / female)  
A-coded

#### Termination

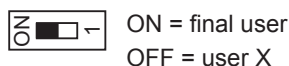

#### J1939 Definitions (Default settings)

Baud rate	250 kbit/s
Address	172 (0xAC)
Arbitrary address capable	1
Industry Group	5
Vehicle System	0
System Instance, ECU instance	0
Function	142 (0x8E)
Function instance	0
Manufacturer	343 (0x157)
Identity Number	Device-individual
PGN 65450: encoder position, speed, diagnostic	Proprietary B, Broadcast communication
Transmission repetition rate	50 ms
Data length	8 bytes
PDU format PF	255 (0xFF)
PDU specific PS	0xAA
Default priority	6
Parameter group number PGN	65450 (0xFFAA)