

features

- Suitable for automatic machine insertion
- No rating
- Products with lead-free terminations meet EU RoHS and China RoHS requirements

dimensions and construction

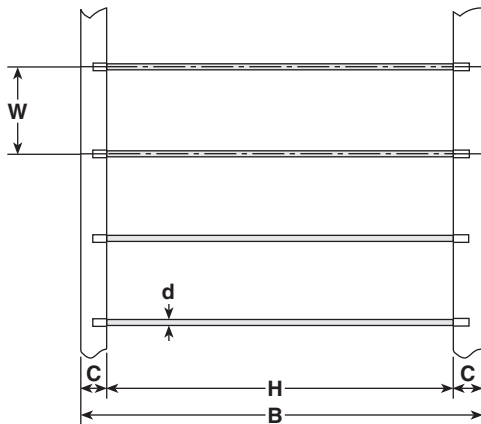

T52 Type	Dimensions inches (mm)				
	H	B	C	W	d nominal
JL5					.02 (0.5)
JL6	2.05±.039 (52.0±1.0)	2.56±.039 (65.0±1.0)	.244±.02 (6.2±0.5)	.2±.015 (5.08±0.38)	.024 (0.6)
JL8					.031 (0.8)

T26 Type	Dimensions inches (mm)				
	H	B	C	W	d nominal
JL5					.02 (0.5)
JL6	1.02 ^{+0.039} ₋₀ (26.0 ⁺¹ ₋₀)	1.54±.039 (39.0±1.0)	.244±.02 (6.2±0.5)	.1972±.02 (5.0±0.5)	.024 (0.6)
JL8					.031 (0.8)

applications and ratings

Part Designation	Maximum Resistance	Maximum Current Ratings
JL5	10mΩ	8 Amps
JL6		10 Amps
JL8		12 Amps

ordering information

New Part #	JL	8	C	T52	A
	Type	Nominal Diameter	Termination Material	Taping and Forming	Packaging
		5 (24 gauge) 6 (22 gauge) 8 (20 gauge)	C: SnCu (Other termination styles available, contact factory for options)	T26, T52	A: Ammo

For further information on packaging, please refer to Appendix C.