

Single Phase Bridge Rectifier

1N4436 — 1N4438

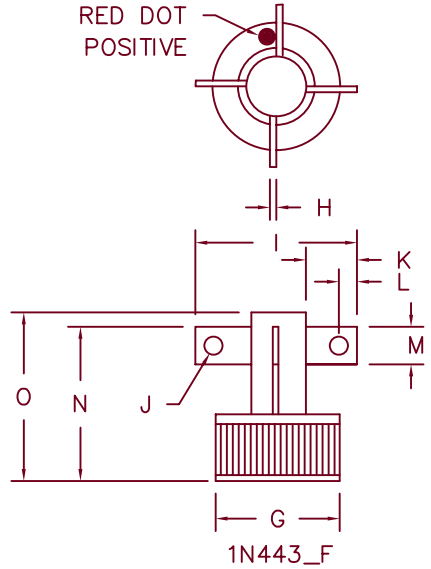

Note: Electrically Isolated

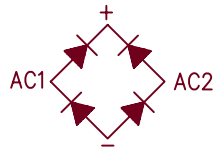
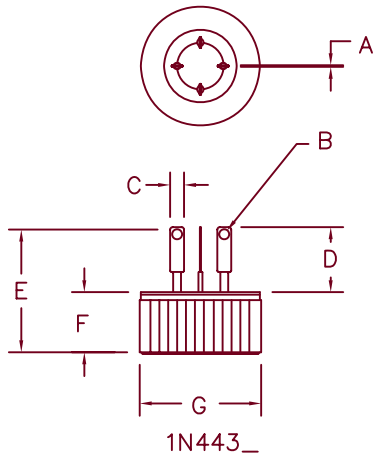
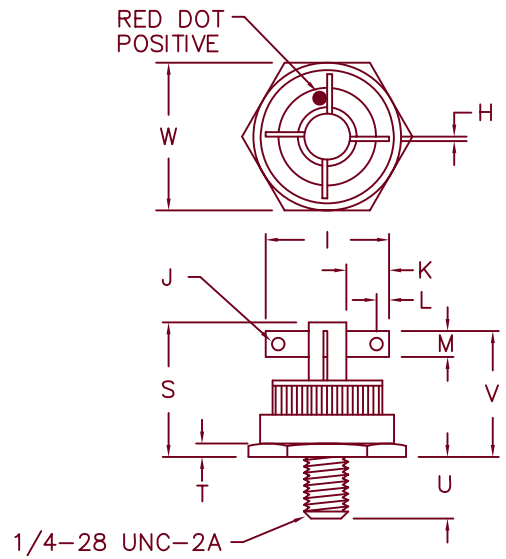
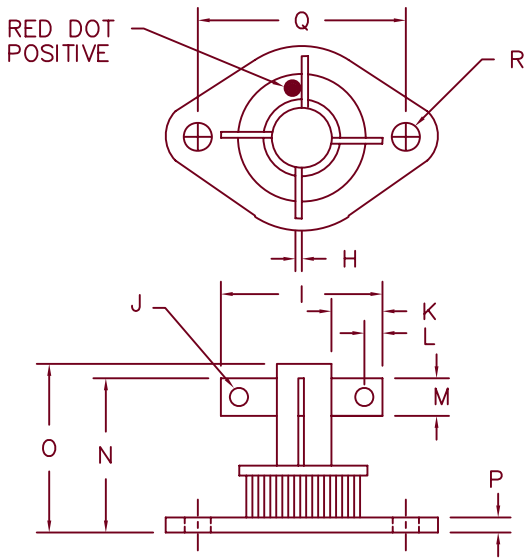

1N443_FT ← For Parts w/o Flags Delete F → 1N443_FS

Dim.	Inches		Millimeter		Notes
	Minimum	Maximum	Minimum	Maximum	
A	.018	.028	0.46	0.71	
B	---	.070 typ.	---	---	Dia.
C	---	.125 typ.	---	---	
D	.290	.330	7.37	8.38	
E	---	.825	---	20.95	
F	.390	.420	9.90	10.67	
G	.751	.755	19.07	19.18	
H	---	.032 typ.	---	---	
I	---	1.0	---	25.4	
J	---	.11 typ.	---	---	Dia.
K	.250	---	6.35	---	

Dim.	Inches		Millimeter		Notes
	Minimum	Maximum	Minimum	Maximum	
L	---	.125 Typ.	---	---	
M	---	.187 Typ.	---	---	
N	---	.830	---	21.08	
O	---	.930	---	23.62	
P	---	.135	---	3.43	
Q	1.177	1.197	29.90	30.40	
R	.151	.161	3.84	4.10	Dia.
S	---	1.20	---	30.48	
T	---	.125 typ.	---	---	
U	.340	.400	8.64	10.16	
V	---	1.10	---	27.94	
W	---	.875	---	22.83	



LAWRENCE

6 Lake Street
Lawrence, MA 01841
PH: (978) 620-2600
FAX: (978) 689-0803
www.microsemi.com

05-01-07 Rev. 3

1N4436 – 1N4438

Microsemi
Catalog Number

1N4436
1N4437
1N4438

Repetitive Peak
Reverse Voltage

200V
400V
600V

- Glass Passivated Die
- Hermetically sealed
- Soft Recovery
- 160°C Junction temperature
- 2000VDC Isolation voltage

Electrical Characteristics

DC forward current output
Maximum Surge Current
Maximum I^2t For Fusing
Max. Peak Forward Voltage per leg
Max. Peak Reverse Current
Max. Peak Reverse Current

I_o 10A
 I_{FSM} 100 Amps
 I^2t 40A²s
 V_{FM} 1.2 Volts
 I_{RM} 10 μ A
 I_{RM} 1.0 mA

$T_C = 100^\circ\text{C}$, $R_{\theta JC} = 1.5^\circ\text{C/W}$

$I_{FM} = 10\text{A}$: $T_J = 25^\circ\text{C}$
 V_{RRM} , $T_J = 25^\circ\text{C}$
 V_{RRM} , $T_J = 150^\circ\text{C}$

Thermal and Mechanical Characteristics

Storage temp range
Max thermal resistance

T_{STG} , T_{OP}
 $R_{\theta JC}$

-65°C to $+160^\circ\text{C}$
 1.5°C/W junction to case

1N4436 - 1N4438

Figure 1
Typical Forward Characteristics

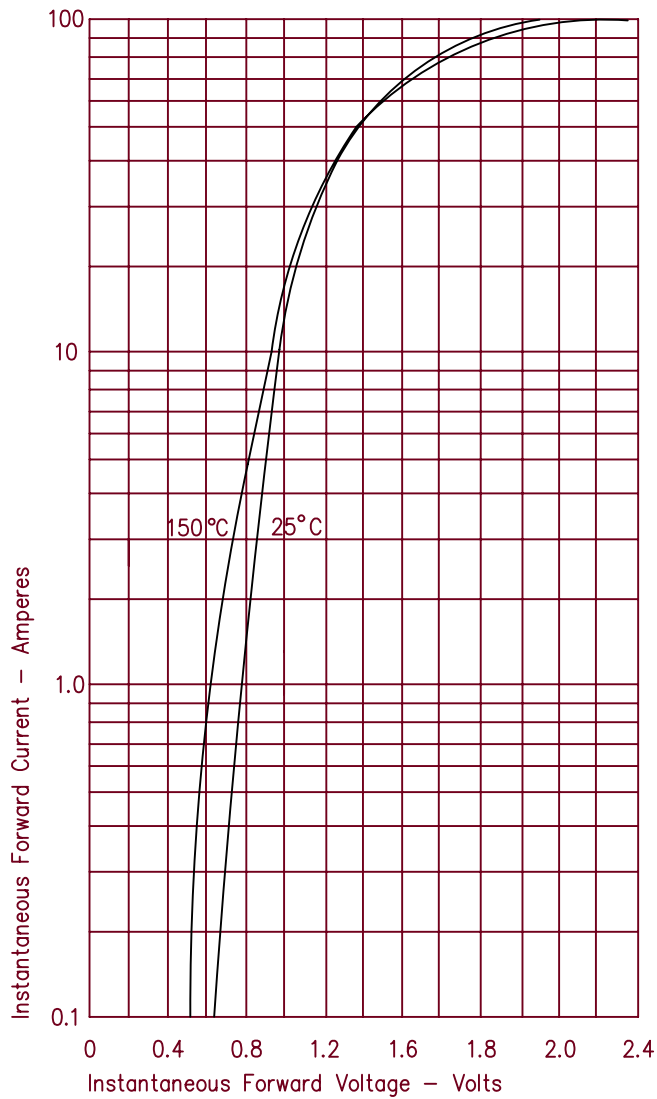

Figure 3
Forward Current Derating

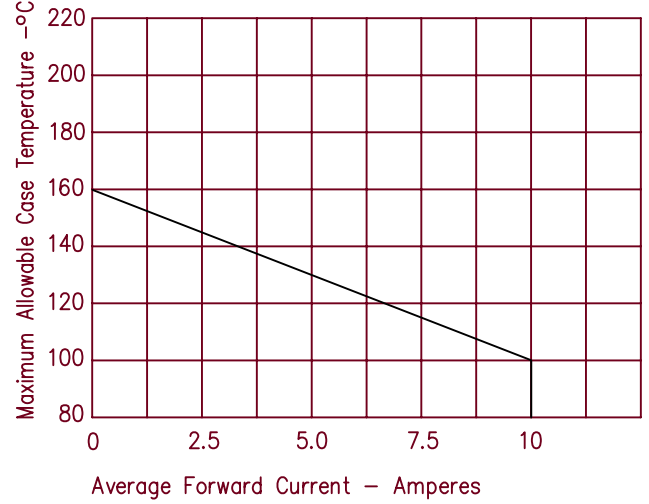

Figure 2
Typical Reverse Characteristics

