

Line sensors

ZADM 023H300.0012

dimension drawing

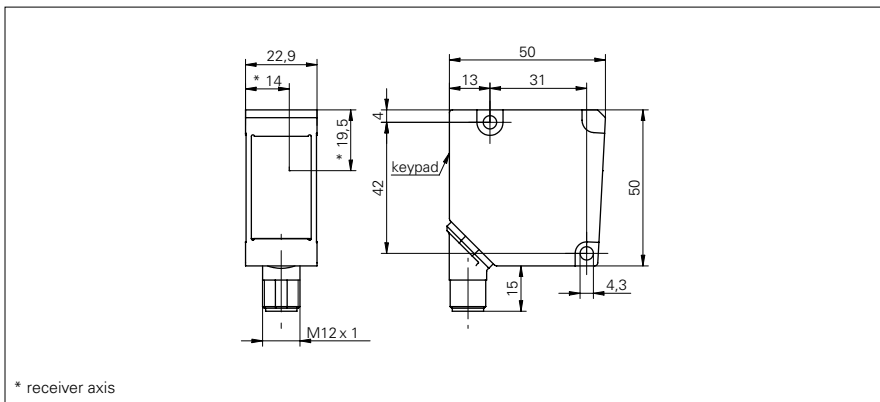

general data

type	measuring mode: edges, center, width
measuring field size	30 mm
measuring distance (to object)	50 mm
measuring frequency	> 500 Hz
resolution	< 0,03 mm
smallest object recognizable	0,3 mm
linearity error relative	< 0,3 %
light source	pulsed infrared diode
wave length	880 nm
adjustment	Teach-in

electrical data

response time	< 2 ms
voltage supply range +Vs	15 ... 28 VDC
current consumption max. (no load)	150 mA
output signal	4 ... 20 mA
switching output	NPN
output function	Out 1 / Out 2
output current	< 100 mA
interface	analog and RS 485
baud rate	19200, adjustable
reverse polarity protection	yes, Vs to GND

mechanical data

width / diameter	23 mm
type	rectangular
housing material	die-cast zinc
front (optics)	glass
connection types	connector M12 8 pin, rotatable

ambient conditions

operating temperature	0 ... +55 °C
protection class	IP 67

photo



connection diagram

