

**ISOTOP<sup>®</sup> Buck chopper  
Trench + Field Stop IGBT<sup>®</sup>**

**$V_{CES} = 1200V$   
 $I_C = 75A @ T_c = 80^\circ C$**

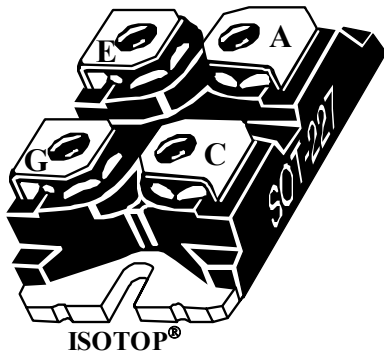
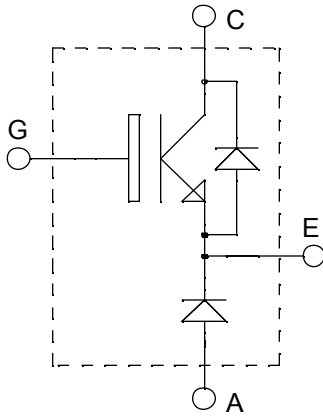

### Application

- AC and DC motor control
- Switched Mode Power Supplies

### Features

- Trench + Field Stop IGBT<sup>®</sup> Technology
  - Low voltage drop
  - Low tail current
  - Switching frequency up to 20 kHz
  - Soft recovery parallel diodes
  - Low diode VF
  - Low leakage current
  - Avalanche energy rated
  - RBSOA and SCSOA rated
- ISOTOP<sup>®</sup> Package (SOT-227)
- Very low stray inductance
- High level of integration

### Benefits

- Low conduction losses
- Stable temperature behavior
- Very rugged
- Direct mounting to heatsink (isolated package)
- Low junction to case thermal resistance
- Easy paralleling due to positive  $T_C$  of  $V_{CESat}$
- RoHS Compliant

### Absolute maximum ratings

Symbol	Parameter	Max ratings	Unit
$V_{CES}$	Collector - Emitter Breakdown Voltage	1200	V
$I_{C1}$	Continuous Collector Current	$T_C = 25^\circ C$	A
$I_{C2}$		$T_C = 80^\circ C$	
$I_{CM}$	Pulsed Collector Current	$T_C = 25^\circ C$	175
$V_{GE}$	Gate - Emitter Voltage	$\pm 20$	V
$P_D$	Maximum Power Dissipation	$T_C = 25^\circ C$	416
$I_{FAV}$	Maximum Average Forward Current	$T_C = 80^\circ C$	A
$I_{FRMS}$	RMS Forward Current (Square wave, 50% duty)		
			34

 **CAUTION:** These Devices are sensitive to Electrostatic Discharge. Proper Handling Procedures Should Be Followed.

All ratings @  $T_j = 25^\circ\text{C}$  unless otherwise specified

**Electrical Characteristics**

<i>Symbol</i>	<i>Characteristic</i>	<i>Test Conditions</i>	<i>Min</i>	<i>Typ</i>	<i>Max</i>	<i>Unit</i>
$I_{CES}$	Zero Gate Voltage Collector Current	$V_{GE} = 0\text{V}$ , $V_{CE} = 1200\text{V}$			5	mA
$V_{CE(on)}$	Collector Emitter on Voltage	$V_{GE} = 15\text{V}$ $I_C = 75\text{A}$	$T_j = 25^\circ\text{C}$ $T_j = 125^\circ\text{C}$	1.4 2.0	2.1	V
$V_{GE(th)}$	Gate Threshold Voltage	$V_{GE} = V_{CE}$ , $I_C = 3\text{mA}$	5.0		6.5	V
$I_{GES}$	Gate – Emitter Leakage Current	$V_{GE} = \pm 20\text{V}$ , $V_{CE} = 0\text{V}$			500	nA

**Dynamic Characteristics**

<i>Symbol</i>	<i>Characteristic</i>	<i>Test Conditions</i>	<i>Min</i>	<i>Typ</i>	<i>Max</i>	<i>Unit</i>
$C_{ies}$	Input Capacitance	$V_{GE} = 0\text{V}$		5340		pF
$C_{oes}$	Output Capacitance	$V_{CE} = 25\text{V}$		280		
$C_{res}$	Reverse Transfer Capacitance	$f = 1\text{MHz}$		240		
$T_{d(on)}$	Turn-on Delay Time	Resistive Switching ( $25^\circ\text{C}$ )		260		ns
$T_r$	Rise Time	$V_{GE} = 15\text{V}$ $V_{Bus} = 600\text{V}$		30		
$T_{d(off)}$	Turn-off Delay Time	$I_C = 75\text{A}$		420		
$T_f$	Fall Time	$R_G = 4.7\Omega$		70		
$T_{d(on)}$	Turn-on Delay Time	Inductive Switching ( $125^\circ\text{C}$ )		290		ns
$T_r$	Rise Time	$V_{GE} = 15\text{V}$ $V_{Bus} = 600\text{V}$		45		
$T_{d(off)}$	Turn-off Delay Time	$I_C = 75\text{A}$		520		
$T_f$	Fall Time	$R_G = 4.7\Omega$		90		
$E_{on}$	Turn-on Switching Energy			7		mJ
$E_{off}$	Turn-off Switching Energy			9.5		

**Chopper diode ratings and characteristics**

Symbol	Characteristic	Test Conditions	Min	Typ	Max	Unit
V <sub>F</sub>	Diode Forward Voltage	I <sub>F</sub> = 30A		2.0	2.5	V
		I <sub>F</sub> = 60A		2.3		
		I <sub>F</sub> = 30A	T <sub>j</sub> = 125°C	1.8		
I <sub>RM</sub>	Maximum Reverse Leakage Current	V <sub>R</sub> = 1200V	T <sub>j</sub> = 25°C		250	μA
		V <sub>R</sub> = 1200V	T <sub>j</sub> = 125°C		500	
C <sub>T</sub>	Junction Capacitance	V <sub>R</sub> = 200V		32		pF
t <sub>rr</sub>	Reverse Recovery Time	I <sub>F</sub> =1A, V <sub>R</sub> =30V di/dt = 100A/μs	T <sub>j</sub> = 25°C	31		ns
	Reverse Recovery Time	I <sub>F</sub> = 30A V <sub>R</sub> = 800V di/dt = 200A/μs	T <sub>j</sub> = 25°C	370		
I <sub>RRM</sub>	Maximum Reverse Recovery Current		T <sub>j</sub> = 125°C	5		
			T <sub>j</sub> = 25°C	12		
			T <sub>j</sub> = 125°C	660		
Q <sub>rr</sub>	Reverse Recovery Charge		T <sub>j</sub> = 25°C	3450		nC
			T <sub>j</sub> = 125°C			
t <sub>rr</sub>	Reverse Recovery Time	I <sub>F</sub> = 30A	T <sub>j</sub> = 125°C	220		ns
Q <sub>rr</sub>	Reverse Recovery Charge	V <sub>R</sub> = 800V		4650		nC
I <sub>RRM</sub>	Maximum Reverse Recovery Current	di/dt = 1000A/μs		37		A

**Thermal and package characteristics**

Symbol	Characteristic	Min	Typ	Max	Unit
R <sub>thJC</sub>	Junction to Case Thermal Resistance	IGBT		0.3	°C/W
		Diode		1.1	
R <sub>thJA</sub>	Junction to Ambient (IGBT & Diode)			20	
V <sub>ISOL</sub>	RMS Isolation Voltage, any terminal to case t = 1 min, I <sub>isol</sub> < 1mA, 50/60Hz	2500			V
T <sub>J</sub> , T <sub>STG</sub>	Storage Temperature Range	-55		150	°C
T <sub>L</sub>	Max Lead Temp for Soldering: 0.063" from case for 10 sec			300	
Torque	Mounting torque (Mounting = 8-32 or 4mm Machine and terminals = 4mm Machine)			1.5	N.m
Wt	Package Weight		29.2		g

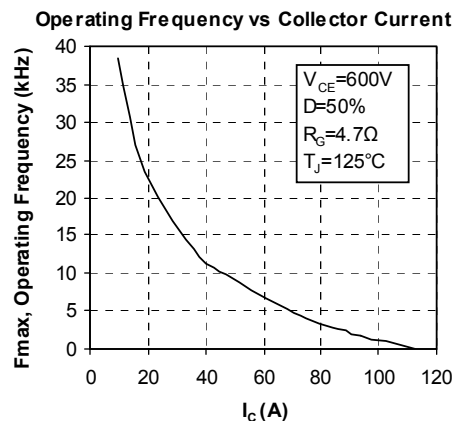
**Typical IGBT Performance Curve**

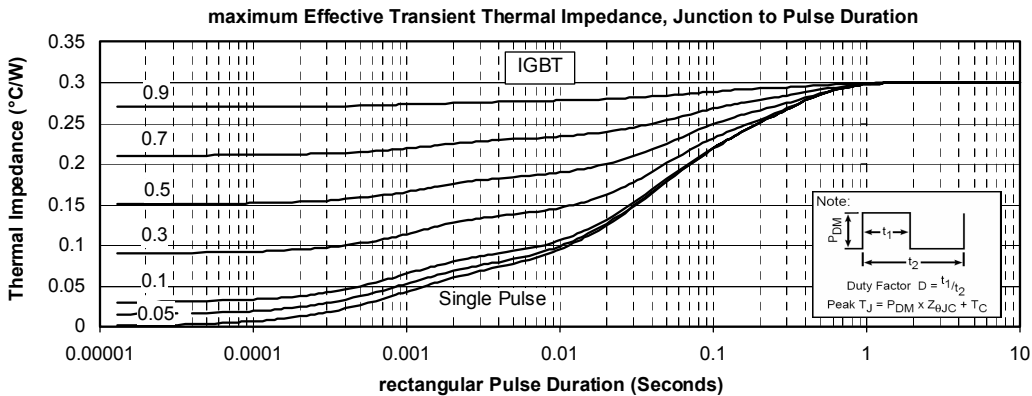
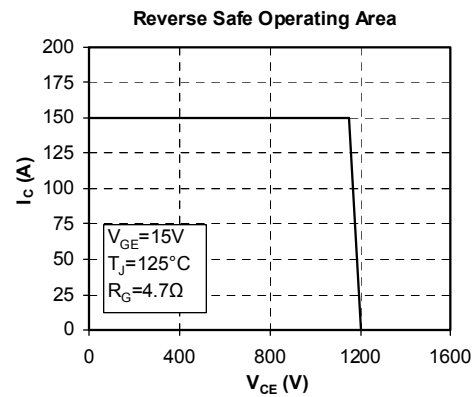
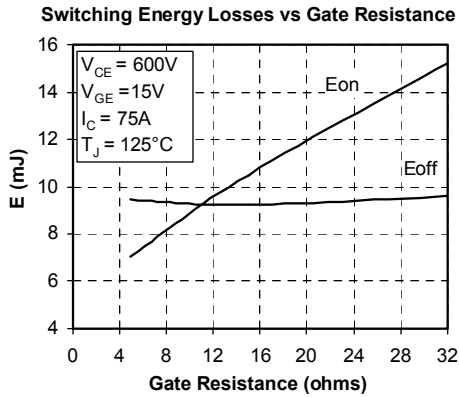
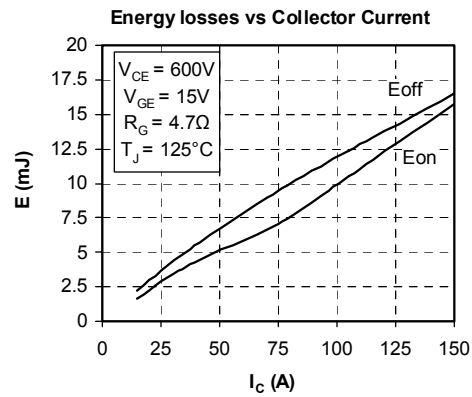
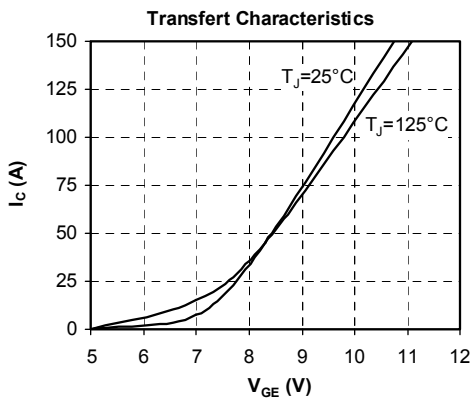
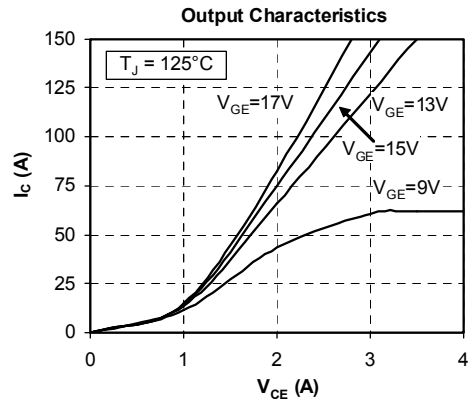
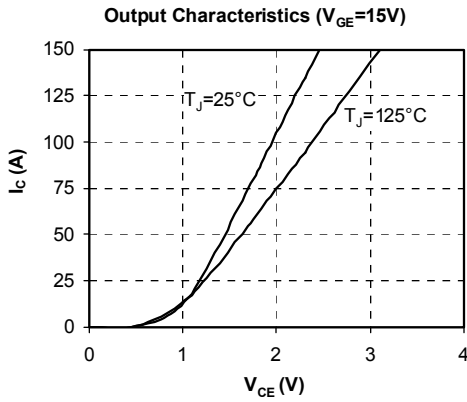

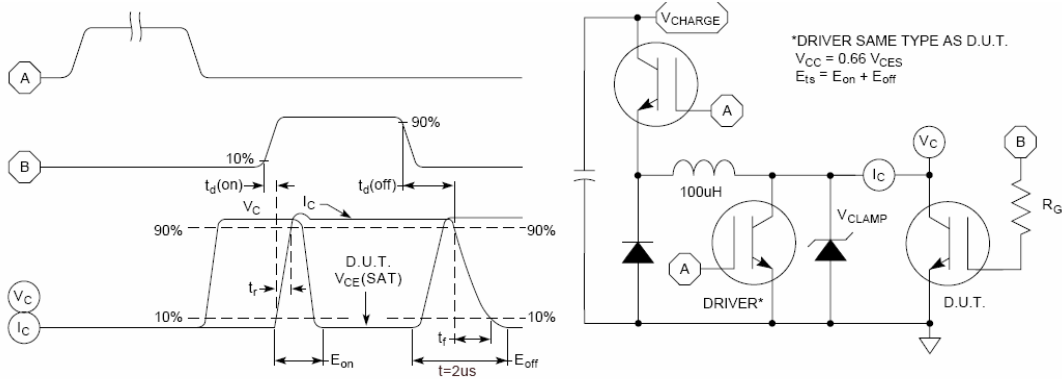

Figure 15, Switching Loss Test Circuit and Waveforms

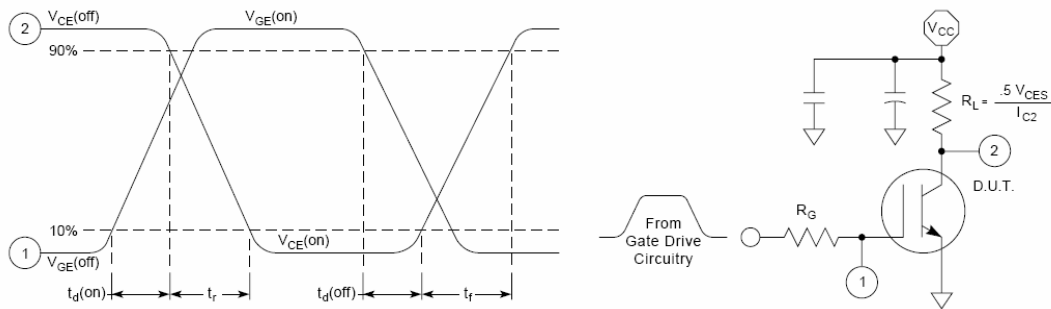

Figure 16, Resistive Switching Time Test Circuit and Waveforms

## Typical Diode Performance Curve

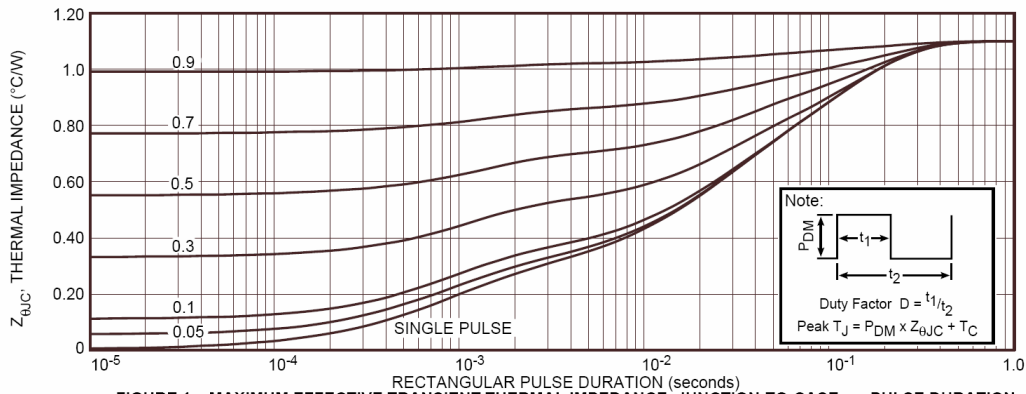

FIGURE 1a. MAXIMUM EFFECTIVE TRANSIENT THERMAL IMPEDANCE, JUNCTION-TO-CASE vs. PULSE DURATION

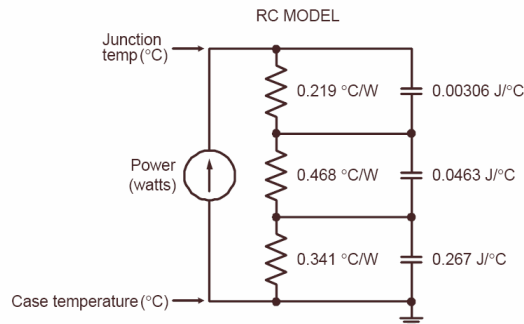

FIGURE 1b, TRANSIENT THERMAL IMPEDANCE MODEL

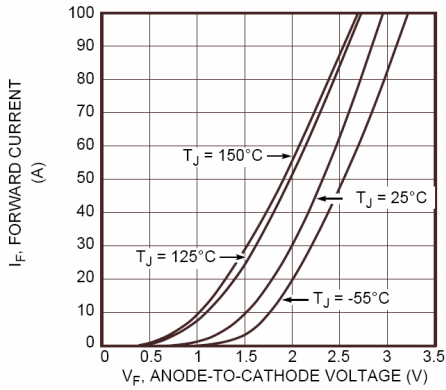

Figure 2. Forward Current vs. Forward Voltage

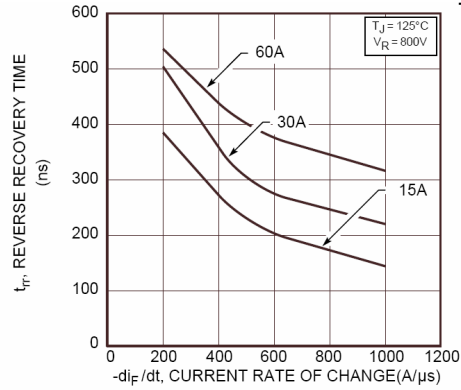

Figure 3. Reverse Recovery Time vs. Current Rate of Change

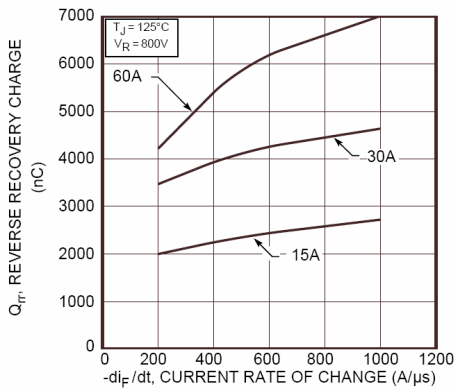

Figure 4. Reverse Recovery Charge vs. Current Rate of Change

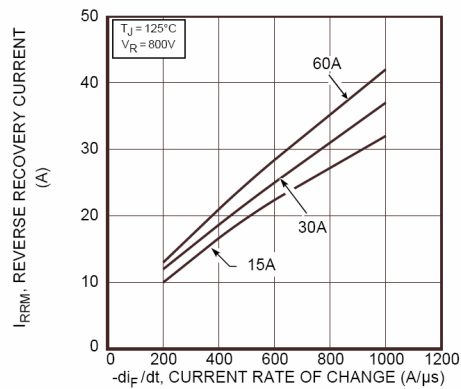

Figure 5. Reverse Recovery Current vs. Current Rate of Change

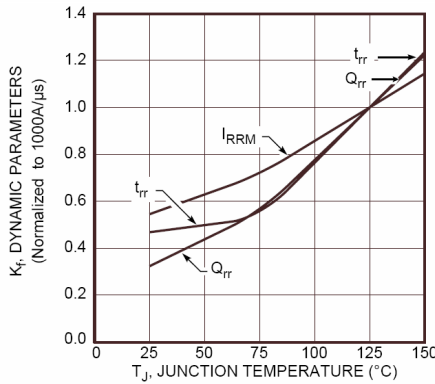

Figure 6. Dynamic Parameters vs. Junction Temperature

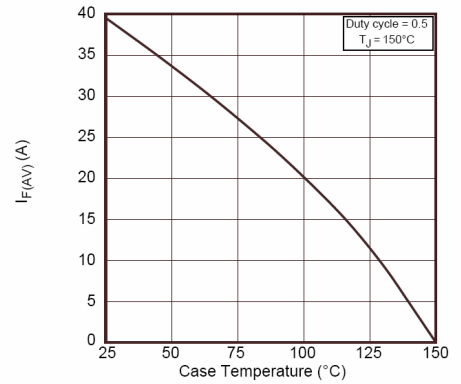

Figure 7. Maximum Average Forward Current vs. Case Temperature

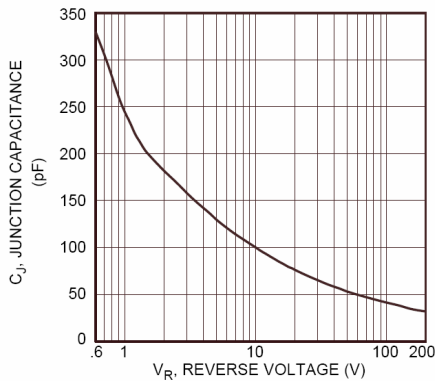

Figure 8. Junction Capacitance vs. Reverse Voltage

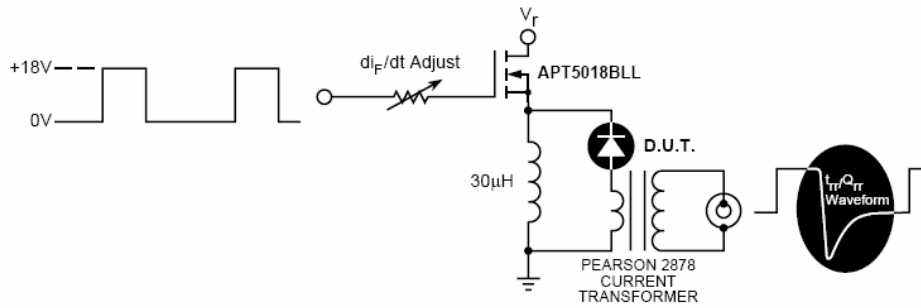

Figure 9. Diode Test Circuit

- 1  $I_F$  - Forward Conduction Current
- 2  $di_F/dt$  - Rate of Diode Current Change Through Zero Crossing.
- 3  $I_{RRM}$  - Maximum Reverse Recovery Current.
- 4  $t_{TR}$  - Reverse Recovery Time, measured from zero crossing where diode current goes from positive to negative, to the point at which the straight line through  $I_{RRM}$  and  $0.25 \cdot I_{RRM}$  passes through zero.
- 5  $Q_{TR}$  - Area Under the Curve Defined by  $I_{RRM}$  and  $t_{TR}$ .

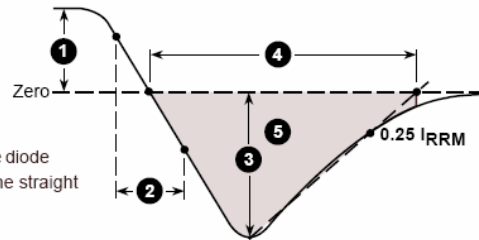
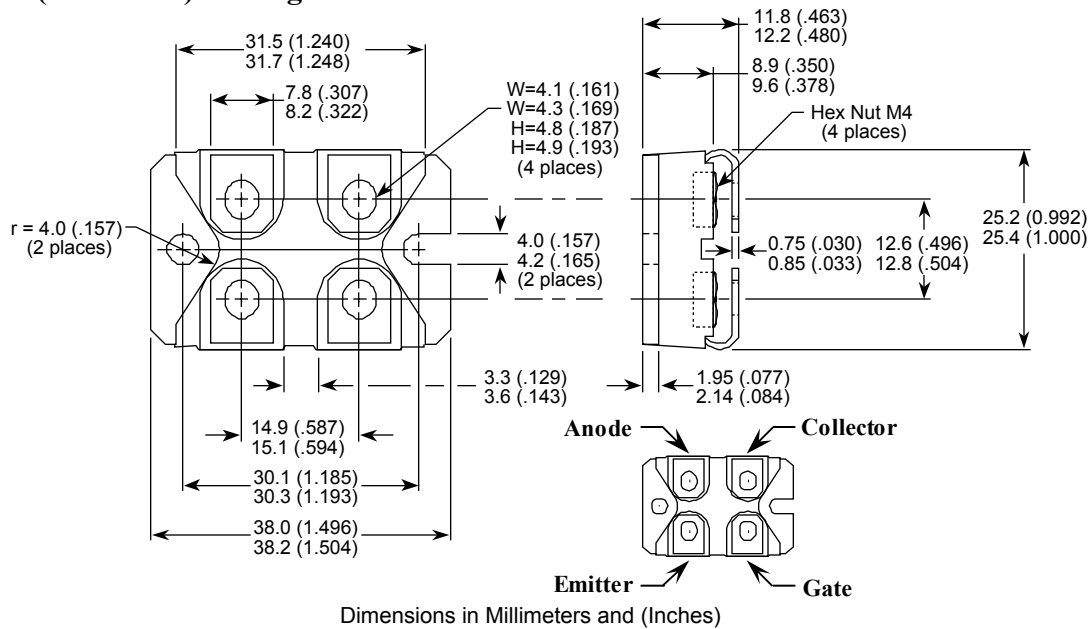

Figure 10. Diode Reverse Recovery Waveform and Definitions

## SOT-227 (ISOTOP<sup>®</sup>) Package Outline



ISOTOP<sup>®</sup> is a registered trademark of ST Microelectronics NV

Microsemi reserves the right to change, without notice, the specifications and information contained herein

Microsemi's products are covered by one or more of U.S. patents 4,895,810 5,045,903 5,089,434 5,182,234 5,019,522 5,262,336 6,503,786 5,256,583 4,748,103 5,283,202 5,231,474 5,434,095 5,528,058 and foreign patents. U.S. and Foreign patents pending. All Rights Reserved.