

**ISOTOP[®] Buck chopper
MOSFET + SiC chopper diode
Power module**

$V_{DSS} = 1000V$
 $R_{DSon} = 400m\Omega$ typ @ $T_j = 25^\circ C$
 $I_D = 22A$ @ $T_c = 25^\circ C$

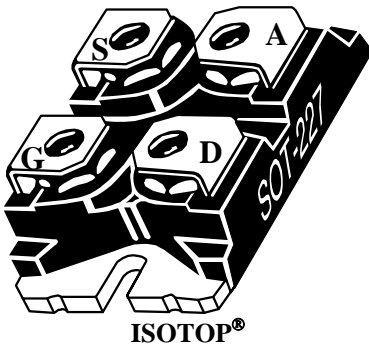
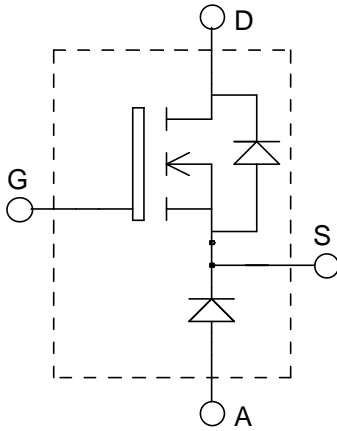

Application

- AC and DC motor control
- Switched Mode Power Supplies

Features

- **Power MOS 8TM MOSFET**
 - Low R_{DSon}
 - Low input and Miller capacitance
 - Low gate charge
 - Avalanche energy rated
- **SiC Schottky Diode**
 - Zero reverse recovery
 - Zero forward recovery
 - Temperature Independent switching behavior
 - Positive temperature coefficient on VF
- ISOTOP[®] Package (SOT-227)
- Very low stray inductance
- High level of integration

Benefits

- Outstanding performance at high frequency operation
- Stable temperature behavior
- Very rugged
- Direct mounting to heatsink (isolated package)
- Low junction to case thermal resistance
- Easy paralleling due to positive TC of VCEsat
- RoHS Compliant

Absolute maximum ratings

Symbol	Parameter	Max ratings	Unit
V_{DSS}	Drain - Source Breakdown Voltage	1000	V
I_D	Continuous Drain Current	$T_c = 25^\circ C$	22
		$T_c = 80^\circ C$	17
I_{DM}	Pulsed Drain current	120	A
V_{GS}	Gate - Source Voltage	± 30	V
R_{DSon}	Drain - Source ON Resistance	480	m Ω
P_D	Maximum Power Dissipation	$T_c = 25^\circ C$	463
I_{AR}	Avalanche current (repetitive and non repetitive)	16	A

CAUTION: These Devices are sensitive to Electrostatic Discharge. Proper Handling Procedures Should Be Followed. See application note APT0502 on www.microsemi.com

All ratings @ $T_j = 25^\circ\text{C}$ unless otherwise specified

Electrical Characteristics

Symbol	Characteristic	Test Conditions	Min	Typ	Max	Unit	
I_{DSS}	Zero Gate Voltage Drain Current	$V_{DS} = 1000\text{V}$ $V_{GS} = 0\text{V}$	$T_j = 25^\circ\text{C}$			100	μA
			$T_j = 125^\circ\text{C}$			500	
$R_{DS(on)}$	Drain – Source on Resistance	$V_{GS} = 10\text{V}, I_D = 16\text{A}$		400	480	$\text{m}\Omega$	
$V_{GS(th)}$	Gate Threshold Voltage	$V_{GS} = V_{DS}, I_D = 2.5\text{mA}$	3	4	5	V	
I_{GSS}	Gate – Source Leakage Current	$V_{GS} = \pm 30\text{V}$			± 100	nA	

Dynamic Characteristics

Symbol	Characteristic	Test Conditions	Min	Typ	Max	Unit
C_{iss}	Input Capacitance	$V_{GS} = 0\text{V}$ $V_{DS} = 25\text{V}$ $f = 1\text{MHz}$		6800		pF
C_{oss}	Output Capacitance			700		
C_{rss}	Reverse Transfer Capacitance			92		
Q_g	Total gate Charge	$V_{GS} = 10\text{V}$ $V_{Bus} = 500\text{V}$ $I_D = 16\text{A}$		260		nC
Q_{gs}	Gate – Source Charge			46		
Q_{gd}	Gate – Drain Charge			125		
$T_{d(on)}$	Turn-on Delay Time	Resistive switching @ 25°C $V_{GS} = 15\text{V}$ $V_{Bus} = 667\text{V}$ $I_D = 16\text{A}$ $R_G = 2.2\Omega$		39		ns
T_r	Rise Time			35		
$T_{d(off)}$	Turn-off Delay Time			130		
T_f	Fall Time			33		

SiC chopper diode ratings and characteristics

Symbol	Characteristic	Test Conditions	Min	Typ	Max	Unit	
V_{RRM}	Maximum Peak Repetitive Reverse Voltage		1200			V	
I_{RM}	Maximum Reverse Leakage Current	$V_R = 1200\text{V}$	$T_j = 25^\circ\text{C}$		32	200	μA
			$T_j = 175^\circ\text{C}$		56	1000	
I_F	DC Forward Current			10		A	
V_F	Diode Forward Voltage	$I_F = 10\text{A}$	$T_j = 25^\circ\text{C}$		1.6	1.8	V
			$T_j = 175^\circ\text{C}$		2.3	3	
Q_C	Total Capacitive Charge	$I_F = 10\text{A}, V_R = 600\text{V}$ $di/dt = 500\text{A}/\mu\text{s}$		80		nC	
C	Total Capacitance	$f = 1\text{MHz}, V_R = 200\text{V}$		96		pF	
		$f = 1\text{MHz}, V_R = 400\text{V}$		69			

Thermal and package characteristics

Symbol	Characteristic	Min	Typ	Max	Unit	
R_{thJC}	Junction to Case Thermal Resistance	Mosfet			0.27	$^\circ\text{C}/\text{W}$
		SiC Diode			1.65	
R_{thJA}	Junction to Ambient (IGBT & Diode)			20		
V_{ISOL}	RMS Isolation Voltage, any terminal to case $t = 1\text{min}, I_{isol} < 1\text{mA}, 50/60\text{Hz}$	2500			V	
T_J, T_{STG}	Storage Temperature Range	-40		150	$^\circ\text{C}$	
T_L	Max Lead Temp for Soldering: 0.063" from case for 10 sec			300		
Torque	Mounting torque (Mounting = 8-32 or 4mm Machine and terminals = 4mm Machine)			1.5	N.m	
Wt	Package Weight		29.2		g	

SOT-227 (ISOTOP[®]) Package Outline

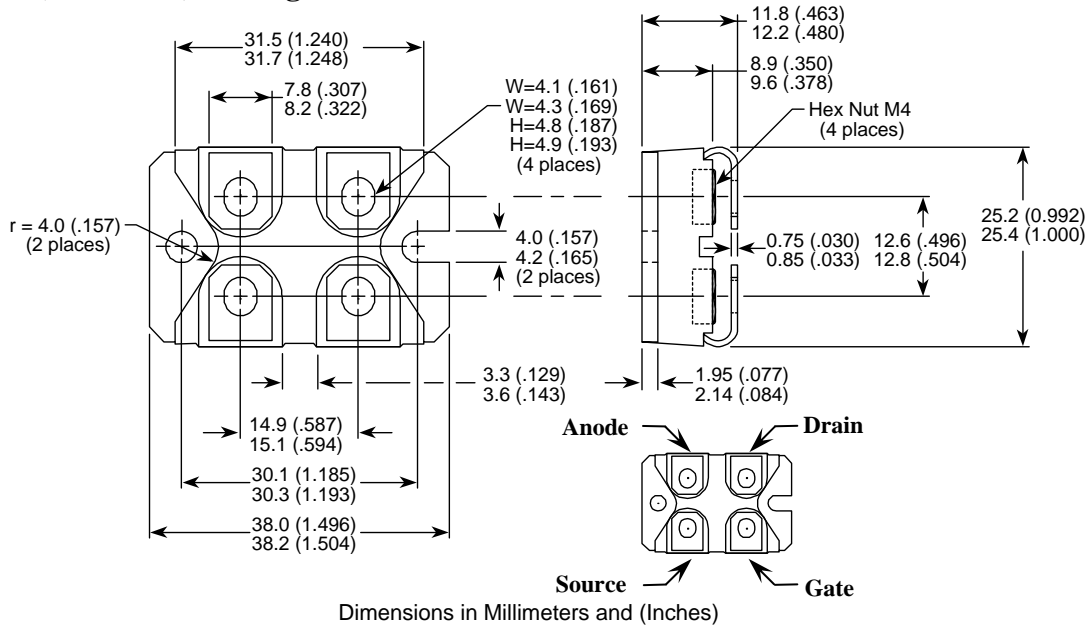

Typical Mosfet Performance Curve

Maximum Effective Transient Thermal Impedance, Junction to Case vs Pulse Duration

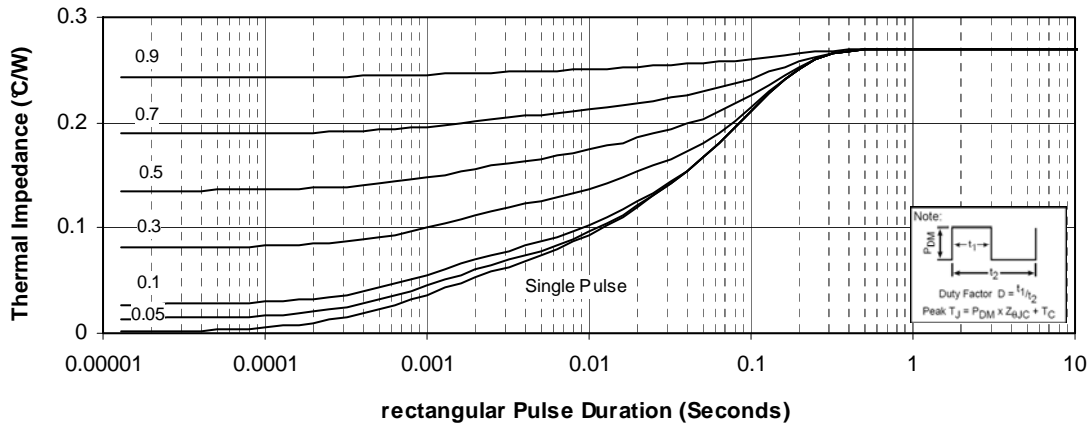

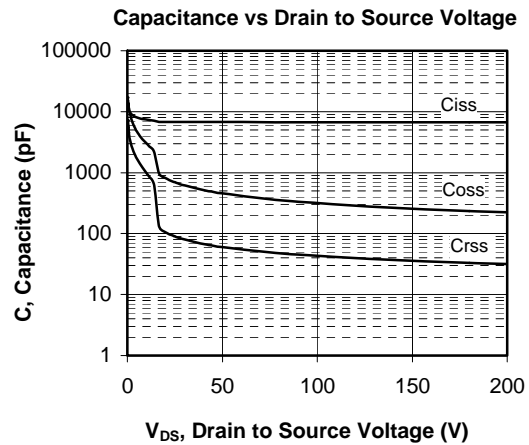
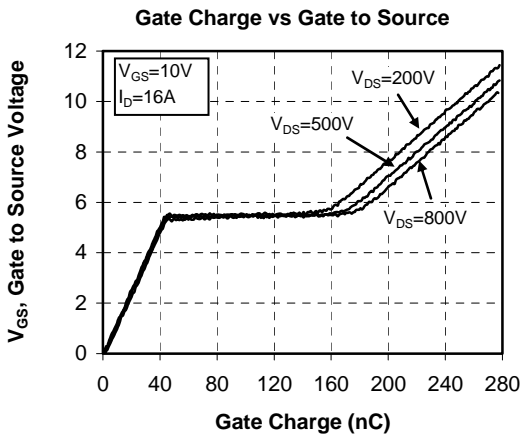
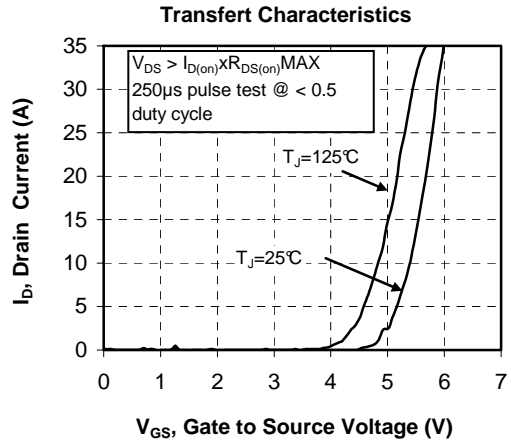
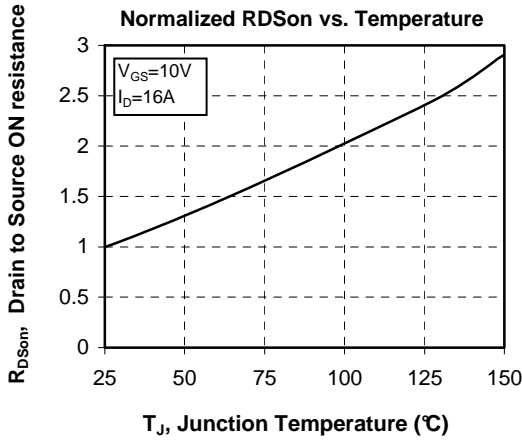
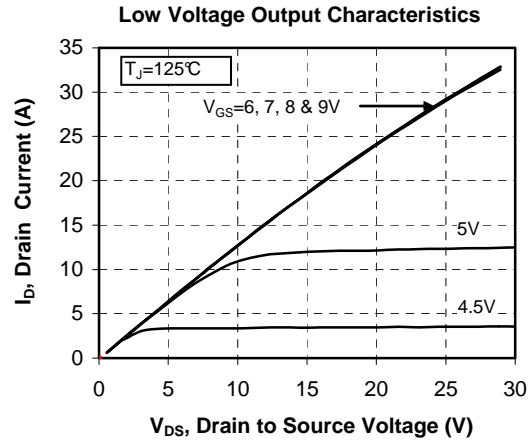
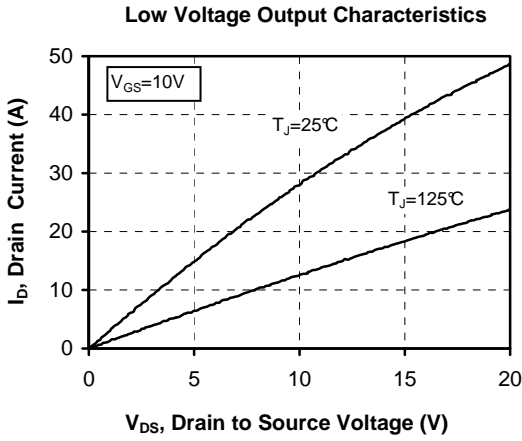

Typical SiC Diode Performance Curve

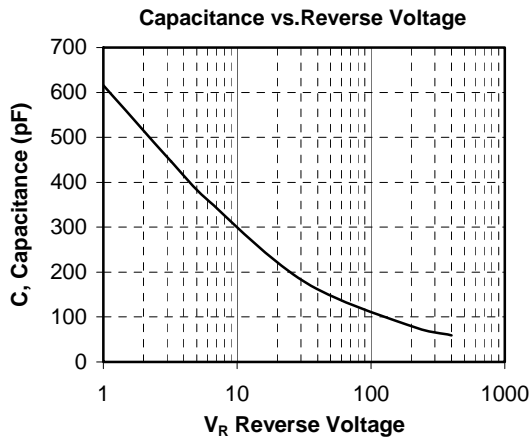
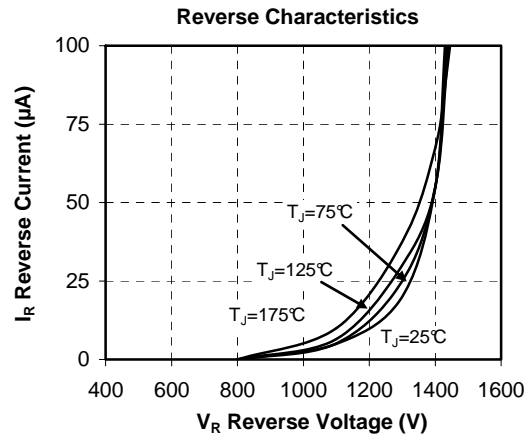
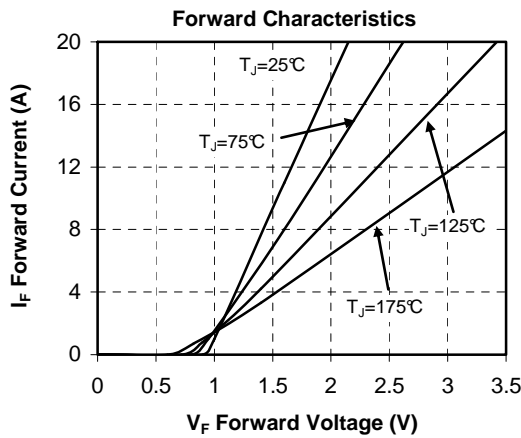
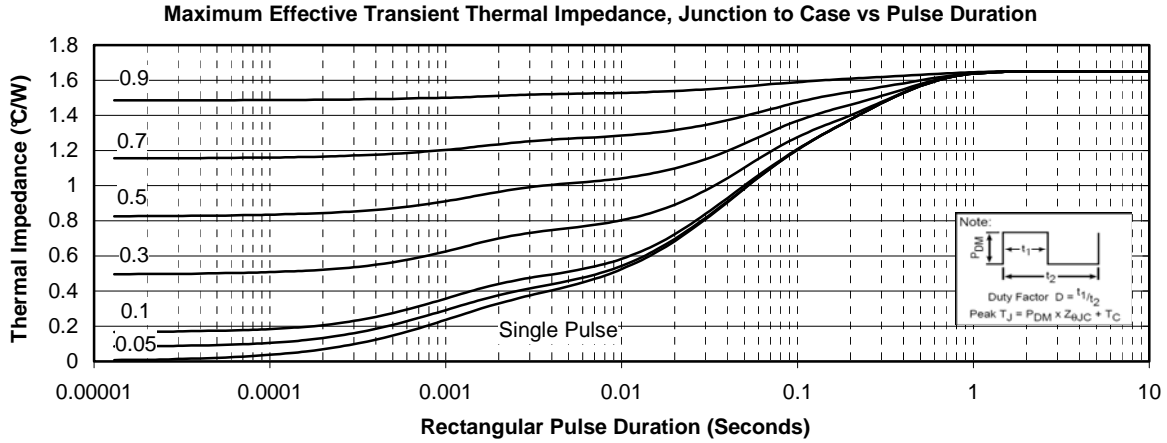

ISOTOP® is a registered trademark of ST Microelectronics NV

Microsemi reserves the right to change, without notice, the specifications and information contained herein

Microsemi's products are covered by one or more of U.S. patents 4,895,810 5,045,903 5,089,434 5,182,234 5,019,522 5,262,336 6,503,786 5,256,583 4,748,103 5,283,202 5,231,474 5,434,095 5,528,058 6,939,743 7,352,045 5,283,201 5,801,417 5,648,283 7,196,634 6,664,594 7,157,886 6,939,743 7,342,262 and foreign patents. U.S and Foreign patents pending. All Rights Reserved.