

## ISOTOP<sup>®</sup> Fast Diode Full Bridge Power Module

$V_{RRM} = 200V$   
 $I_F = 30A @ T_c = 80^{\circ}C$

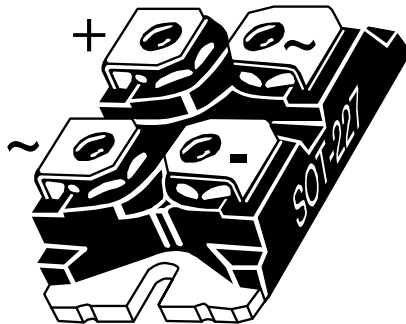
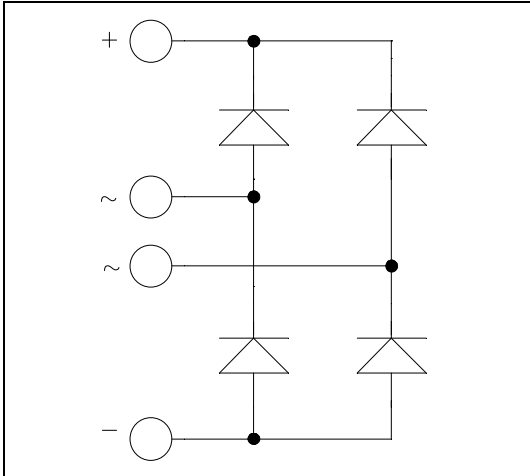

### Application

- Switch mode power supplies rectifier
- Induction heating
- Welding equipment
- High speed rectifiers

### Features

- Ultra fast recovery times
- Soft recovery characteristics
- High blocking voltage
- High current
- Low leakage current
- Very low stray inductance
- High level of integration
- ISOTOP<sup>®</sup> Package (SOT-227)

### Benefits

- Outstanding performance at high frequency operation
- Low losses
- Low noise switching
- Direct mounting to heatsink (isolated package)
- Low junction to case thermal resistance
- RoHS Compliant

### Absolute maximum ratings

Symbol	Parameter	Max ratings	Unit		
$V_R$	Maximum DC reverse Voltage	200	V		
$V_{RRM}$	Maximum Peak Repetitive Reverse Voltage				
$I_{F(AV)}$	Maximum Average Forward Current	Duty cycle = 50%	$T_C = 25^{\circ}C$	45	A
			$T_C = 80^{\circ}C$	30	
$I_{FSM}$	Non-Repetitive Forward Surge Current	8.3ms	$T_J = 45^{\circ}C$	320	



**CAUTION:** These Devices are sensitive to Electrostatic Discharge. Proper Handling Procedures Should Be Followed. See application note APT0502 on [www.microsemi.com](http://www.microsemi.com)

All ratings @  $T_j = 25^\circ\text{C}$  unless otherwise specified

**Electrical Characteristics**

Symbol	Characteristic	Test Conditions	Min	Typ	Max	Unit
$V_F$	Diode Forward Voltage	$I_F = 30\text{A}$		1.1	1.3	V
		$I_F = 60\text{A}$		1.4		
		$I_F = 30\text{A}$	$T_j = 125^\circ\text{C}$		0.9	
$I_{RM}$	Maximum Reverse Leakage Current	$V_R = 200\text{V}$	$T_j = 25^\circ\text{C}$		250	$\mu\text{A}$
			$T_j = 125^\circ\text{C}$		500	
$C_T$	Junction Capacitance	$V_R = 200\text{V}$		95		pF

**Dynamic Characteristics**

Symbol	Characteristic	Test Conditions	Min	Typ	Max	Unit
$t_{rr}$	Reverse Recovery Time	$I_F = 30\text{A}$ $V_R = 133\text{V}$ $di/dt = 200\text{A}/\mu\text{s}$	$T_j = 25^\circ\text{C}$		24	ns
			$T_j = 125^\circ\text{C}$		48	
$Q_{rr}$	Reverse Recovery Charge		$T_j = 25^\circ\text{C}$		33	nC
			$T_j = 125^\circ\text{C}$		150	
$I_{RRM}$	Reverse Recovery Current		$T_j = 25^\circ\text{C}$		3	A
			$T_j = 125^\circ\text{C}$		6	
$t_{rr}$	Reverse Recovery Time	$I_F = 30\text{A}$ $V_R = 133\text{V}$ $di/dt = 1000\text{A}/\mu\text{s}$	$T_j = 125^\circ\text{C}$		31	ns
$Q_{rr}$	Reverse Recovery Charge				355	nC
$I_{RRM}$	Reverse Recovery Current				19	A

**Thermal and package characteristics**

Symbol	Characteristic	Min	Typ	Max	Unit
$R_{thJC}$	Junction to Case Thermal resistance			1.2	$^\circ\text{C}/\text{W}$
$R_{thJA}$	Junction to Ambient			20	
$V_{ISOL}$	RMS Isolation Voltage, any terminal to case $t = 1\text{ min}$ , $I_{isol} < 1\text{mA}$ , 50/60Hz	2500			V
$T_J, T_{STG}$	Storage Temperature Range	-55		150	$^\circ\text{C}$
$T_L$	Max Lead Temp for Soldering: 0.063" from case for 10 sec			300	
Torque	Mounting torque (Mounting = 8-32 or 4mm Machine and terminals = 4mm Machine)			1.5	N.m
Wt	Package Weight		29.2		g

## Typical Performance Curve

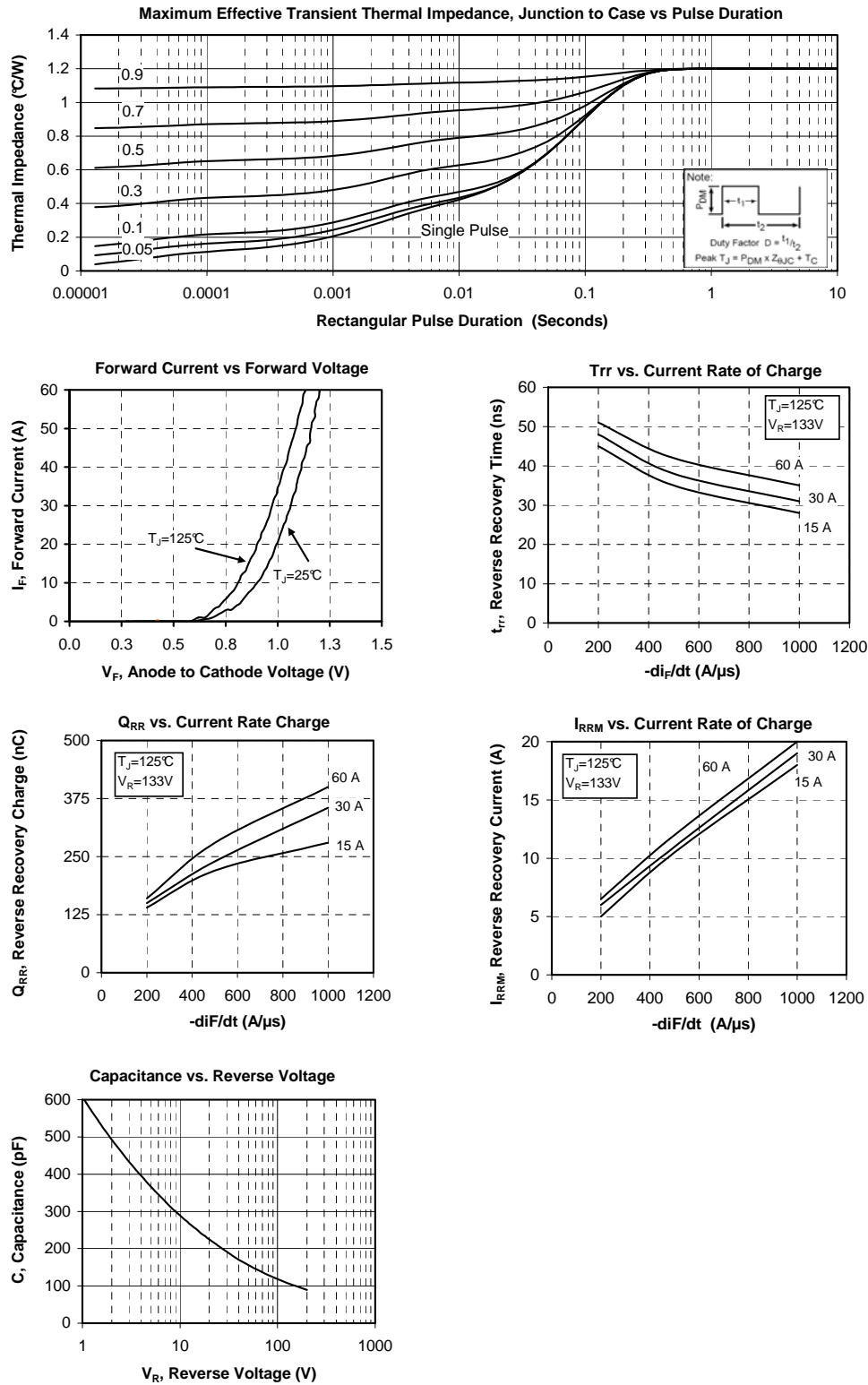

## SOT-227 (ISOTOP®) Package Outline

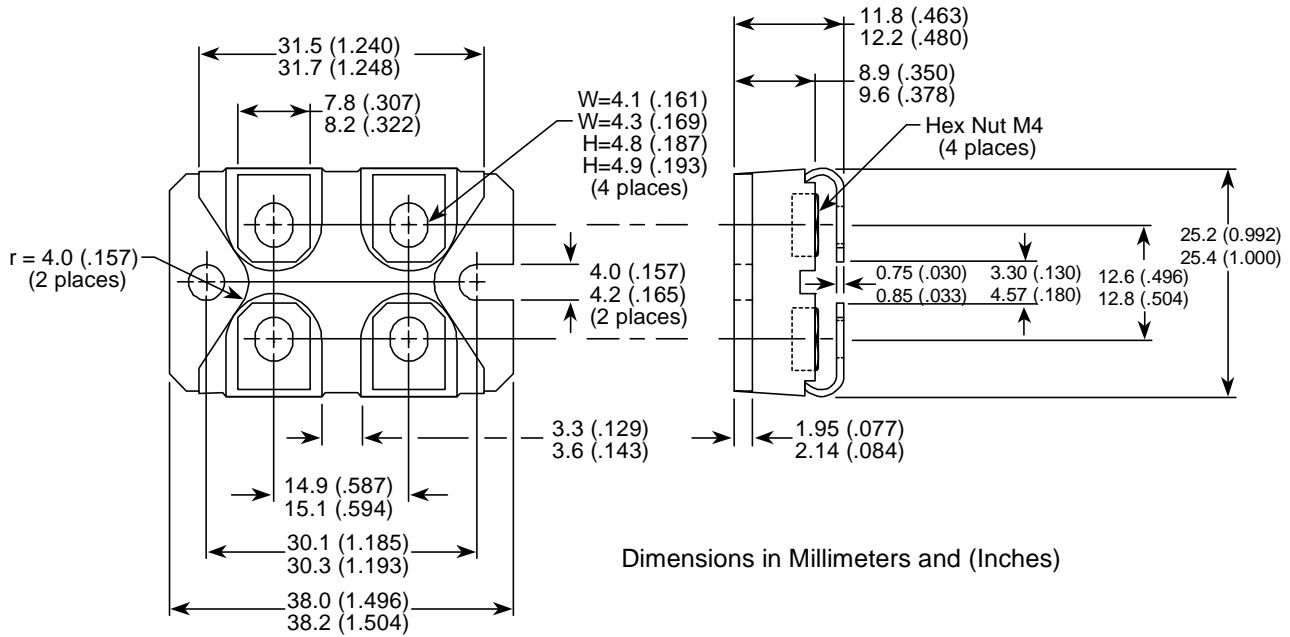

ISOTOP® is a registered trademark of ST Microelectronics NV

Microsemi reserves the right to change, without notice, the specifications and information contained herein

Microsemi's products are covered by one or more of U.S. patents 4,895,810 5,045,903 5,089,434 5,182,234 5,019,522 5,262,336 6,503,786 5,256,583 4,748,103 5,283,202 5,231,474 5,434,095 5,528,058 6,939,743 7,352,045 5,283,201 5,801,417 5,648,283 7,196,634 6,664,594 7,157,886 6,939,743 7,342,262 and foreign patents. U.S and Foreign patents pending. All Rights Reserved.