

Features

- Low Cost
- Direction-of-Motion Sensing
- High-Volume Design
- Various Output Power Levels
- Dual-Channel Output
- Pulsed DC Input Voltage
- Low-Power Consumption

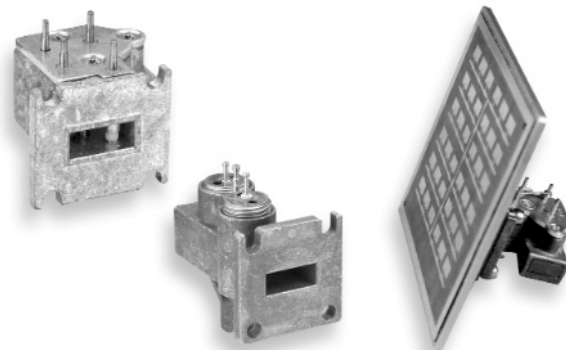

Applications

- Automatic Door Openers
- Intrusion Alarm Systems
- Speed Radars
- Presence Sensing
- Traffic Control Systems
- Level Sensing

Description

Microsemi's waveguide output transceivers are a reliable source of microwave power for speed and motion detection applications. The transceivers are a fully integrated module, with a Gunn diode mounted in the cavity for the transmitter and one or two Schottky barrier diodes in the receiver. An IF output is generated whose frequency is proportional to the target's velocity. With the two-mixer design, the direction-of-motion is obtained as a phase difference between the two IF outputs.

Specifications @ 25 °C

Model Number	Description	Operating Frequency (GHz)	Output Power (mW)	Typ. Freq. Drift/ Temperature (KHz/°C)	Nominal Sensitivity (dBc)	Typ. Mixer Phasing (Degrees)	Typ. Operating Voltage (V _{DC})	Max. Operating Current (mA)
<i>X Band Transceivers</i>								
MO86728	Single IF Output	10.525	5 Min.	450	-95		+7.5 to +8.5	150
MO86735	Dual IF Output	10.525	5 Min.	450	-95	75–105	8.5	200
<i>K Band Transceivers</i>								
MO9061	Single IF Output	24.125	5 Min.	1000	-92		5	100
MO9062	Dual IF Output	24.125	5 Min.	1000	-92	50–130	5	100
MO9081	Pulsed DC	24.125	10–20	1000	-90		+6 to +8	100
MO9082	Pulsed DC, Dual IF Output	24.125	10–20	1000	-90	50–130	+6 to +8	100
MO9300	Single IF Output	24.125	2–5	750	-90		+4 to +6	250
MO9062-22	Dual IF Output	24.125	5 Min.	1000	-90	75–105	5	100
MO9096	Dual IF Output, with Microstrip Planar Antenna	24.125	8 Min.	1000	-90	60–120	+3.5 to +6.5	220
<i>Ka Band Transceivers</i>								
MO9402	Dual IF Output	35.5	5 Min.	1500	-90	75–105	+3.5 to +6.0	300

Other frequencies and power levels available upon request.

Operating temperature is -30°C to +70°C.
Storage temperature is -40°C to +85°C.

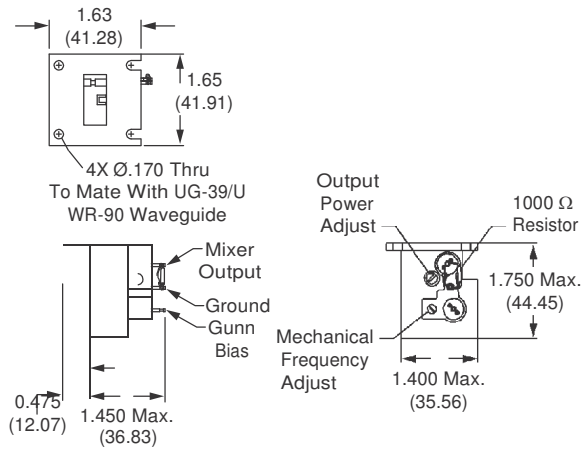
MO86728

Dimensions are in inches (mm).

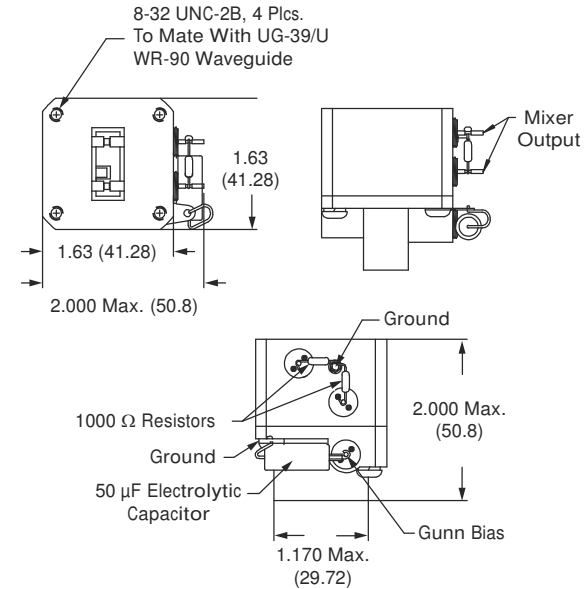
MO86735

Dimensions are in inches (mm).

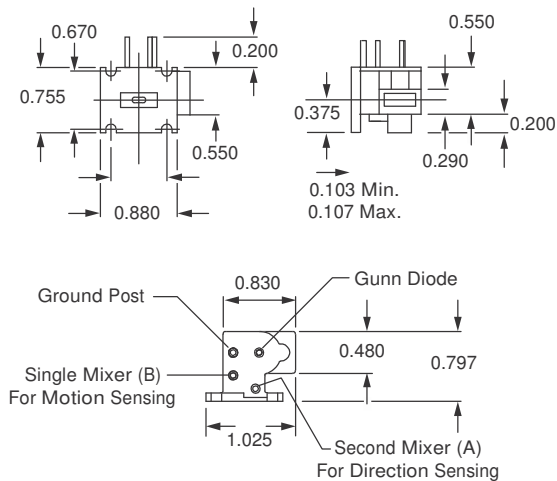
**MO9061, MO9062, MO9062-22,
MO9081, MO9082**

Dimensions are in inches.

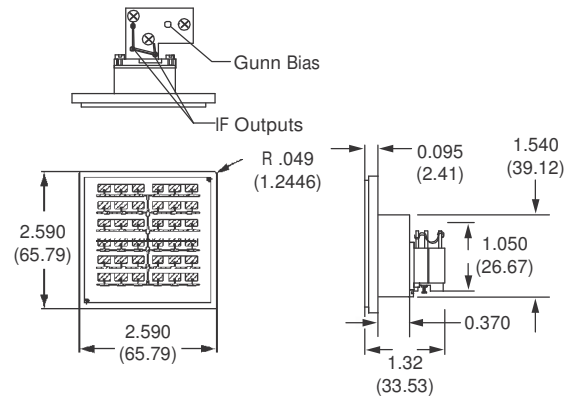
MO9096

Dimensions are in inches (mm).

MO9300

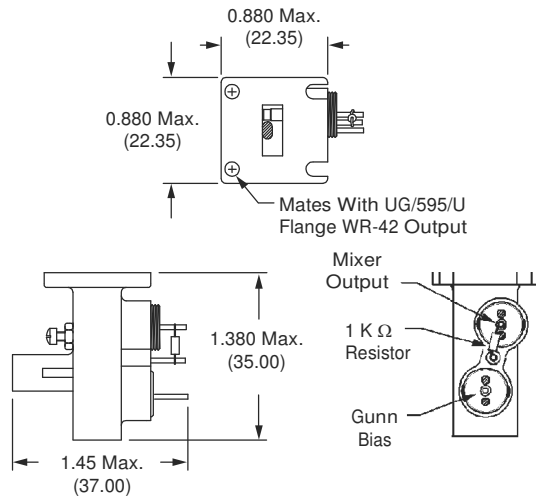

Dimensions are in inches (mm).

MO9402

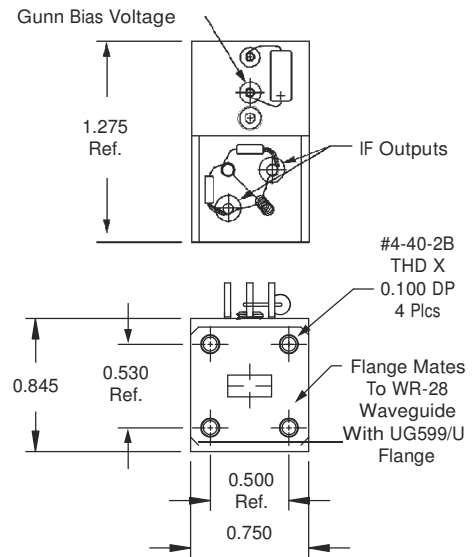

Dimensions are in inches.