

Ultrasonic distance measuring sensors

UNDK 30U6112

dimension drawing

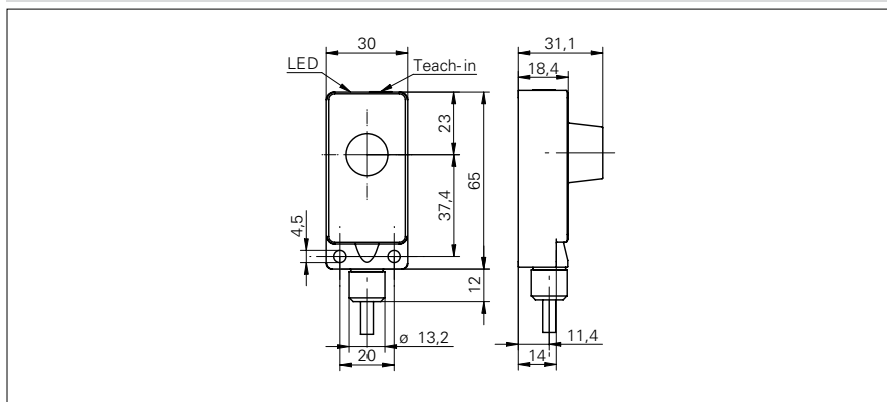

general data

scanning range sd	60 ... 400 mm
scanning range close limit Sdc	60 ... 400 mm
scanning range far limit Sde	60 ... 400 mm
repeat accuracy	< 0,5 mm
resolution	< 0,3 mm
adjustment	Teach-in
sonic frequency	400 kHz
response time ton	< 60 ms
release time toff	< 60 ms
alignment aid	target indication flashing
light indicator	yellow LED / red LED
temperature drift	< 2 % of distance to target So

electrical data

voltage supply range +Vs	15 ... 30 VDC
current consumption max. (no load)	35 mA
output circuit	voltage output
output signal	0 ... 10 V / 10 ... 0 V
output current	< 20 mA
residual ripple	< 10 % Vs
short circuit protection	yes
reverse polarity protection	yes

mechanical data

type	rectangular
housing material	polyester / die-cast zinc
width / diameter	30 mm
height / length	65 mm
depth	31 mm
connection types	cable, 2 m

ambient conditions

operating temperature	-10 ... +60 °C
protection class	IP 67

photo



connection diagram

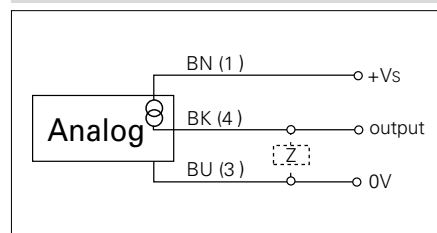

- Analog voltage output 0 - 10 V