

SCRs

.5A, Planar

AA100-AA104
AA107-AA111
AA114-AA118

FEATURES

- Maximum Gate Trigger Current: 2, 20 or 200 μ A
- Tight Gate Trigger Voltage Range: .44 to .6V
- Voltage Ratings: to 400V
- Specified for dv/dt and Switching Time

DESCRIPTION

This data sheet describes Microsemi's AA Series 0.5A SCRs designed for low-current sensing applications. Units are available in a complete range of blocking voltages from 60 to 400 volts.

The AA100 series offers a maximum gate trigger current of 2.0 microamps making it the most sensitive device of its type. The AA107 series has a maximum I_{GT} of 20 μ A while this parameter is specified at 200 μ A for the AA114 series.

ABSOLUTE MAXIMUM RATINGS

	AA100 AA107 AA114	AA101 AA108 AA115	AA102 AA108 AA116	AA103 AA110 AA117	AA104 AA111 AA118
Repetitive Peak Off-State Voltage, V_{DRM}	60V	100V	200V	300V	400V
Repetitive Peak Reverse Voltage, V_{RRM}	60V	100V	200V	300V	400V
Non-Repetitive Peak Reverse Voltage, V_{RSM}	80V	150V	300V	400V	500V
Non-Repetitive Peak Off-State Voltage, V_{DSM}			500V		
D.C. On-State Current, I_T					
75°C Ambient			250mA		
100°C Case			500mA		
Repetitive Peak On-State Current, I_{TRM}					up to 30A
Peak One Cycle Surge (Non-Rep.) On-State Current, I_{TSM}					5A
Peak Gate Current, I_{GM}			250mA		
Average Gate Current, $I_{G(AV)}$			25mA		
Reverse Gate Voltage, V_{GR}			6V		
Operating and Storage Temperature Range			-65°C to +150°C		

MECHANICAL SPECIFICATIONS

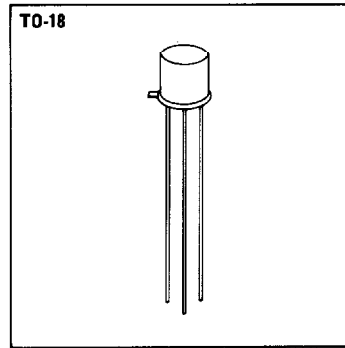
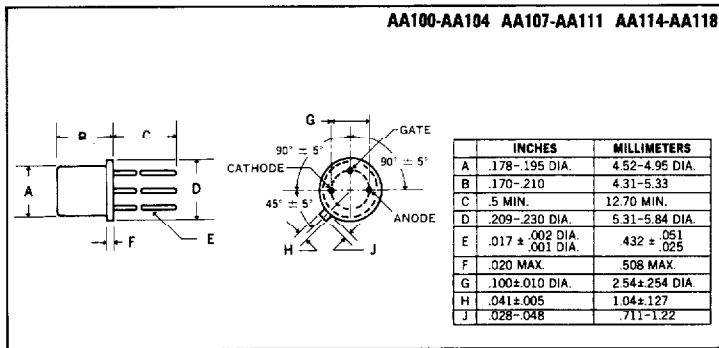

ELECTRICAL SPECIFICATIONS (at 25°C unless noted)

Parameter	Symbol	Min.	Typical	Max.	Units	Test Conditions
SUBGROUP 1						
Visual & Mechanical						
SUBGROUP 2 (25°C TESTS)						
Off-State Current	I_{DRM}	—	.01	0.1	μA	$R_{GK} = 1K, V_{DRM} = \text{Rating}$
Reverse Current	I_{RRM}	—	.01	0.1	μA	$R_{GK} = 1K, V_{RRM} = \text{Rating}$
Reverse Gate Current	I_{GR}	—	0.1	0.2	μA	$V_{GR} = 2V$
Gate Trigger Current	I_{GT}	—	0.2	2.0	μA	$R_{GS} = 10K, V_D = 5V$
AA100-104		—	0.2	2.0	μA	
AA107-111		—	2.0	20	μA	
AA114-118		—	20	200	μA	
Gate Trigger Voltage	V_{GT}	0.44	0.52	0.60	V	$R_{GS} = 100\Omega, V_D = 5V$
On-State Voltage	V_T	—	1.1	1.5	V	$I_T = 1.0 A \text{ (pulse)}$
Holding Current	I_H	0.3	0.5	2.0	mA	$R_{GK} = 1K$
SUBGROUP 3 (25°C TESTS)						
Off-State Voltage — Critical Rate of Rise	dv/dt	50	100	—	V/ μs	$R_{GK} = 1K, V_D = 30V$
Gate Trigger — on Pulse Width	$t_{pg} \text{ (on)}$	—	0.5	2.0	μs	$I_G = 10mA, I_T = 1A, V_D = 30V$
Delay Time	t_d	—	0.6	—	μs	$I_G = 10mA, I_T = 1A, V_D = 30V$
Rise Time	t_r	—	0.4	—	μs	$I_G = 10mA, I_T = 1A, V_D = 30V$
Circuit Commutated Turn-off Time	t_q	—	20	50	μs	$I_T = 1A, I_R = 1A, R_{GK} = 1K$
SUBGROUP 4 (125°C TESTS)						
Off-State Current	I_{DRM}	—	10	20	μA	$R_{GK} = 1K, V_{DRM} = \text{Rating}$
Reverse Current	I_{RRM}	—	30	100	μA	$R_{GK} = 1K, V_{RRM} = \text{Rating}$
Gate Trigger Voltage	V_{GT}	0.15	0.2	—	V	$R_{GS} = 100\Omega, V_D = 5V$
Holding Current	I_H	0.2	0.4	1.5	mA	$R_{GK} = 1K$

Note: Blocking voltage ratings apply over the full operating temperature range, provided the gate is connected to the cathode through a resistor, 1000 ohms or smaller, or other adequate bias is used.

8

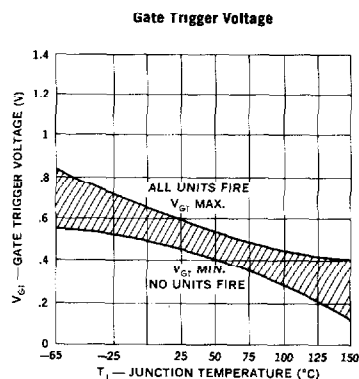
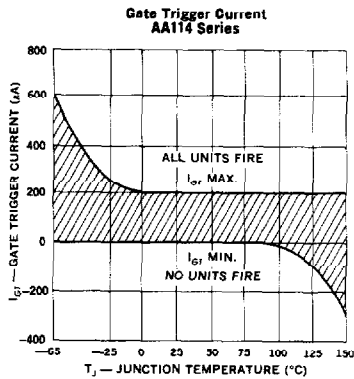
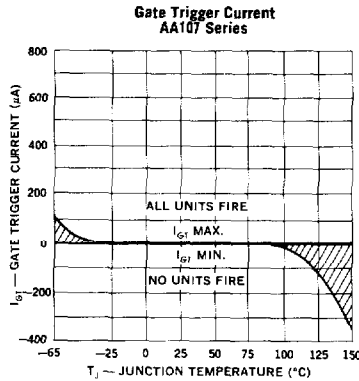
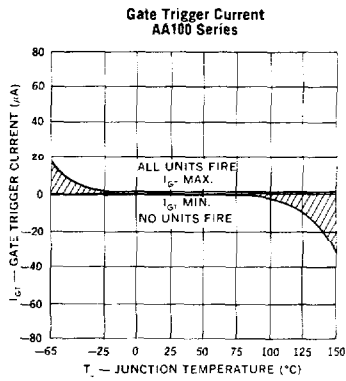

Max. Holding Current

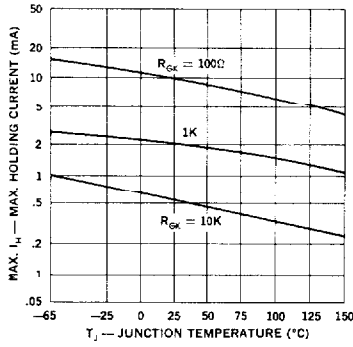

Min. Holding Current

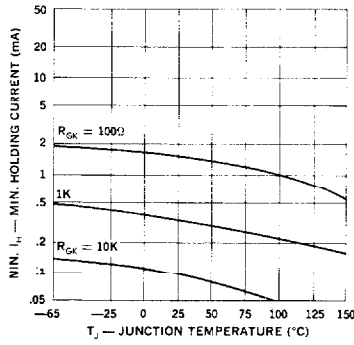

Avg. Current vs. Case Temperature

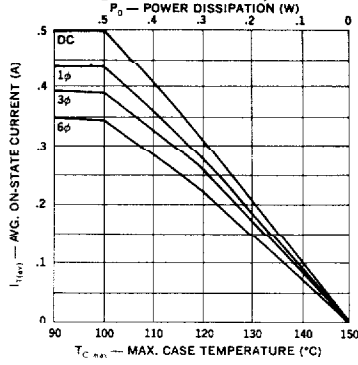

Avg. Current vs. Ambient Temperature

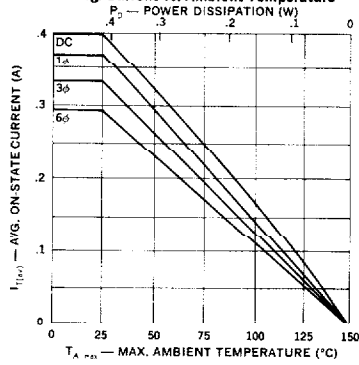

Surge Current

