

REV.	DESCRIPTION	DATE
A	NEW DRAWING	7/30/2007

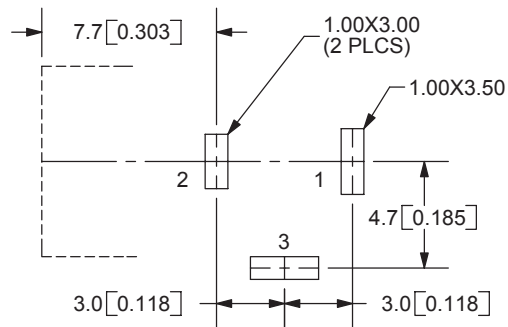
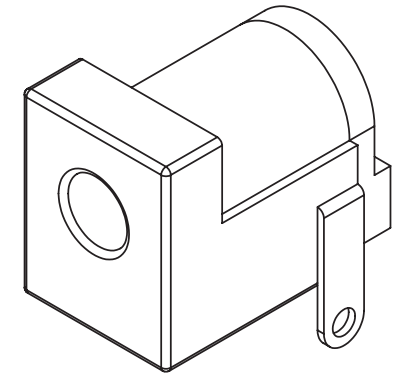
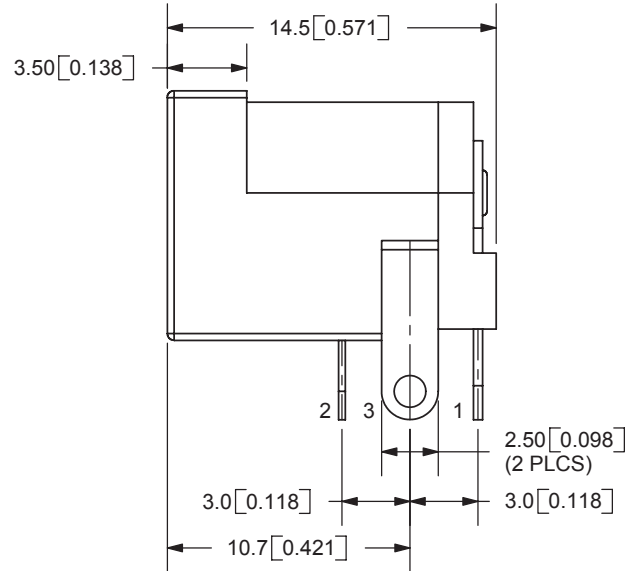
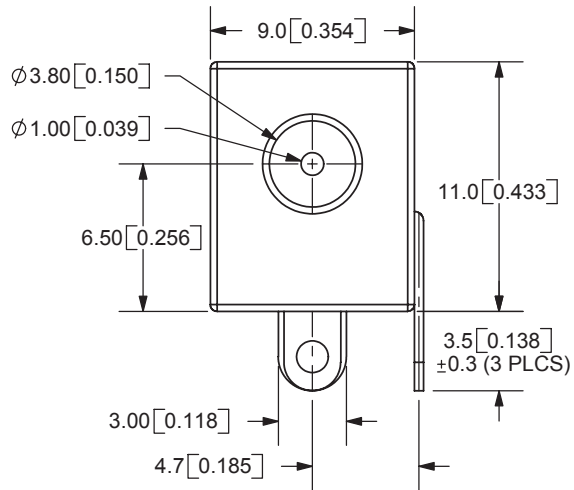

PCB LAYOUT
TOP VIEW

MODEL NO.	PJ-035C
SCHMATIC	

CENTER PIN DIAMETER 1.00mm Dia.

SPECIFICATIONS:
RATING: 16V DC @ 2A
CONTACT RESISTANCE: 50m OHMS MAX
INSULATION RESISTANCE: 100M OHMS MIN: 500V DC
VOLTAGE WITHSTAND: 500V AC R.M.S. FOR 1 MINUTE
LIFE: 5,000 CYCLES
OPERATING TEMP: -25° ~ +85°C

	MATERIAL	PLATING
CENTER PIN	Copper	Nickel
TERMINAL 1	Brass	Tin
TERMINAL 2	Copper Alloy	Tin
TERMINAL 3	Brass	Tin
BODY	PBT	

TOLERANCE:
X.X±0.2mm
X.XX±0.1mm
X.XXX±0.05mm



20050 SW 112th Ave.
Tualatin, OR 97062
Phone: 503-612-2300
800-275-4899
Fax: 503-612-2383
Website: www.cui.com

TITLE: DC POWER JACK	REV: A
PART NO. PJ-035C	UNITS: MM [INCHES]
DRAWN BY: ZRJ	APPROVED BY:
	SCALE: 3:1

PC FILE NAME:
PJ-035C

COPYRIGHT 2007 BY CUI INC.