

Ultrasonic distance measuring sensors

UNAM 12U9914/S14

dimension drawing

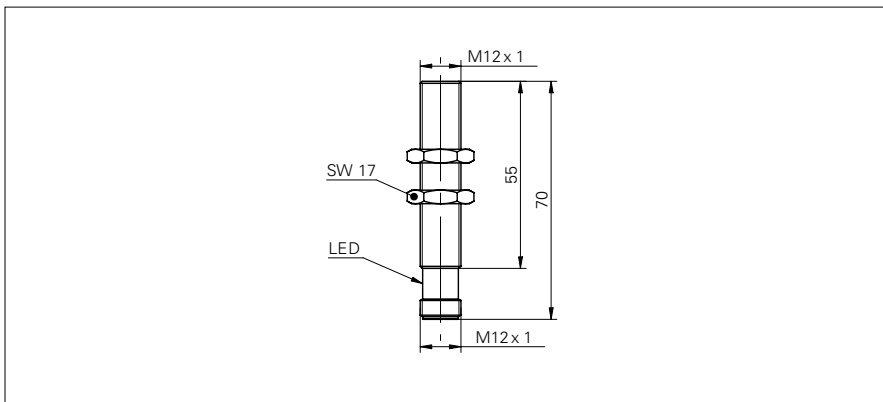

general data

scanning range sd	20 ... 200 mm
scanning range close limit Sdc	20 ... 200 mm
scanning range far limit Sde	20 ... 200 mm
repeat accuracy	< 0,5 mm
resolution	< 0,3 mm
adjustment	external Teach-in
sonic frequency	380 kHz
response time ton	< 30 ms
release time toff	< 30 ms
alignment aid	target indication flashing
light indicator	yellow LED / red LED
temperature drift	< 2 % of distance to target So

electrical data

voltage supply range +Vs	15 ... 30 VDC
current consumption max. (no load)	35 mA
output circuit	voltage output
output signal	0 ... 10 V / 10 ... 0 V
output current	< 20 mA
residual ripple	< 10 % Vs
short circuit protection	yes
reverse polarity protection	yes

mechanical data

type	cylindrical threaded
housing material	brass nickel plated
width / diameter	12 mm
height / length	70 mm
connection types	connector M12

ambient conditions

operating temperature	-10 ... +60 °C
protection class	IP 67

photo



connection diagram

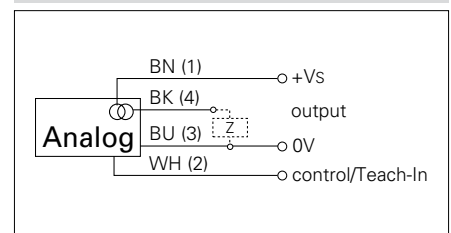

- Analog voltage output 0 - 10 V