



**FEATURES**

- Very Low Supply Current
- Regulated Output Voltage
- Wide Range of Output Voltage is Available from 2.5V to 5.0V by 0.1V Steps
- Output Voltage Accuracy  $\pm 5\%$
- Output Current up to 100mA
- Low Ripple and Low Noise
- Very Low Start-up Voltage
- High Efficiency (Vout = 5V TYP. 87%)
- Few External Components
- Internal Soft-Start
- Low Profile: SOT-23, SOT-89 & SOT-23-5L Pb-Free

**DESCRIPTION**

The APE2901 is a high efficiency VFM Step-up DC/DC converter for small, low input voltage or battery powered systems with ultra low quiescent supply current. The APE2901 accept a positive input voltage from start-up voltage to VOUT and convert it to a higher output voltage in the 2.5 to 5V range.

The APE2901 combine ultra low quiescent supply current and high efficiency to give maximum battery life. The high switching frequency and the internally limited peak inductor current permits the use of small, low cost inductors. Only three external components are needed an inductor a diode and an output capacitor.

The APE2901 is suitable to be used in battery powered equipment where low noise, low ripple and ultra low supply current are required. The APE2901 is available in very small package: SOT-23, SOT-89 & SOT-23-5L.

Typical applications are pagers, cameras & video camera, cellular telephones, wireless telephones, palmtop computer, battery backup supplies, battery powered

**TYPICAL APPLICATION**

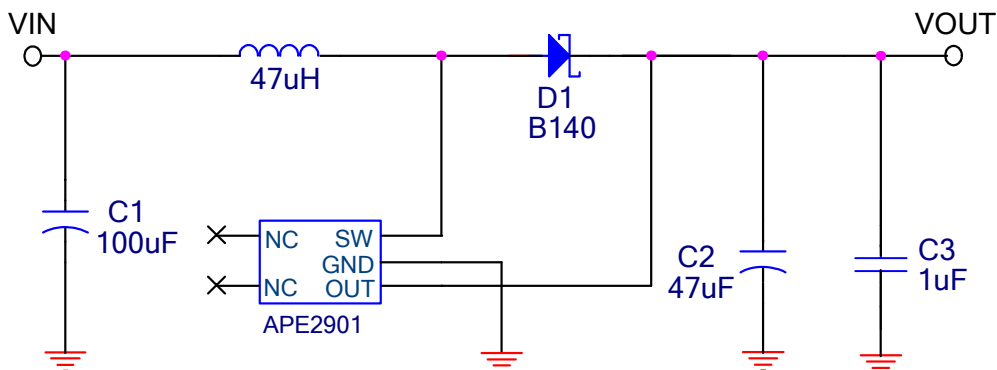

**ORDERING INFORMATION**

<b>APE2901XX-XX</b>	
Package Type	VOUT
Y5 : SOT-23-5L	22 : 2.2V
N : SOT-23	25 : 2.5V
G : SOT-89	26 : 2.6V
	27 : 2.7V
	⋮
	50 : 5.0V



**ABSOLUTE MAXIMUM RATINGS** ( $T_A=25^\circ\text{C}$ )

VIN Supply Voltage( $V_{IN}$ ) .....	5.5 V
SW Voltage( $V_{SW}$ ) .....	5.5 V
OUT Voltage( $V_{OUT}$ ) .....	5.5 V
Power Dissipation( $P_D$ ) .....	$(T_J-T_A) / R_{thja}$ W
Storage Temperature Range( $T_{ST}$ ) .....	-40°C To 150°C
Operating Junction Temperature Range( $T_{OP}$ ) .....	-20°C To + 100°C

Note.  $R_{thJA}$  is measured with the PCB copper area of approximately 1 in<sup>2</sup>(Multi-layer) that need connect to GND pin of the APE2901.

**PACKAGE INFORMATION**

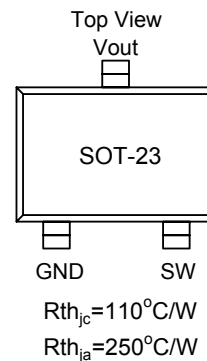
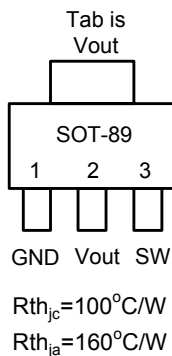
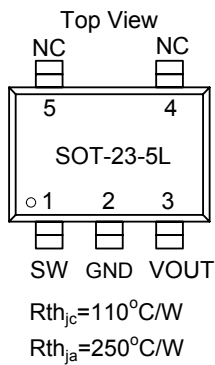

**ELECTRICAL SPECIFICATIONS**

( $V_{IN}=1.8\text{V}$ ,  $I_{OUT}=10\text{mA}$ ,  $T_A=25^\circ\text{C}$ , unless otherwise specified)

Parameter	SYM	TEST CONDITION	MIN	TYP	MAX	UNITS
OUTPUT VOLTAGE ACCURACY	$\Delta V_{OUT}$		-5	-	5	%
START-UP VOLTAGE( $V_{IN}-V_F$ )(Note 1)	$V_{START-UP}$	$I_{OUT}=1\text{mA}$ , $V_{IN}$ =rising from 0 to 2V	-	0.8	1.2	V
HOLD-ON VOLTAGE	$V_{HOLD}$	$I_{OUT}=1\text{mA}$ , $V_{IN}$ =falling from 2 to 0V	0.6	-	-	V
SUPPLY CURRENT	$I_{SUPPLY}$	No Load	-	22	-	uA
INTERNAL SWITCH $R_{DSON}$	$R_{LX(DSON)}$	$I_{LX}=150\text{mA}$	-	850	-	mΩ
INTERNAL LEAKAGE CURRNENT	$I_{LX(leak)}$	$V_{LX}=4\text{V}$ , Forced $V_{OUT}=3.8\text{V}$	-	-	0.5	uA
MAXIMUM OSCILLATOR FREQUENCY	$F_{OSC}$		-	150	-	KHz
OSCILLATOR DUTY ON	$D_{ON}$	To be measure on SW pin	-	77	-	%
EFFICIENCY	$\eta$	$V_{out}=2.5\text{V}\sim 3.0\text{V}$ , $I_{OUT}=50\text{mA}$	-	82	-	%
		$V_{out}=3.1\text{V}\sim 4.0\text{V}$ , $I_{OUT}=50\text{mA}$	-	83	-	%
		$V_{out}=4.1\text{V}\sim 5.0\text{V}$ , $I_{OUT}=50\text{mA}$	-	87	-	%

Note 1: The minimum input voltage for the IC start-up is strictly a function of the VF catch diode.

**PIN DESCRIPTIONS**

PIN SYMBOL	PIN DESCRIPTION
SW	Switch Pin. Connect External Inductor & Diode here.
GND	GND Pin
OUT	Output Voltage



## BLOCK DIAGRAM

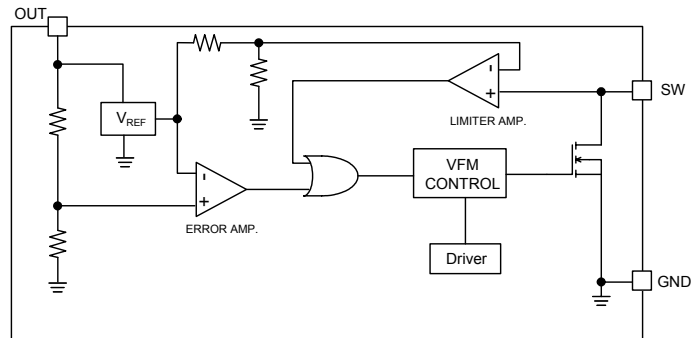

## OPERATION

The APE2901 architecture is built around a VFM CONTROL logic core, switching frequency is set through a built in oscillator.  $T_{ON}$  time is fixed (Typ. 5 $\mu$ S) while  $T_{OFF}$  time is determined by the error amplifier output, a logic signal coming from the comparison made by the Error Amplifier Stage between the signal coming from the output voltage divider network and the internal Band-Gap voltage reference ( $V_{ref}$ ).  $T_{OFF}$  reaches a minimum (Typ. 1.7 $\mu$ S) when heavy load conditions are met (Clock frequency 150KHz). An over current conditions, through the internal power switch, causes a voltage drop  $V_{LX} = R_{DS(on)} \times I_{SW}$  and the  $V_{LX}$  limiter block forces the internal switch to be off, so narrowing  $T_{ON}$  time and limiting internal power dissipation. In this case the switching frequency may be higher than the 150KHz set by the internal clock generator.

VFM control ensures very low quiescent current and high conversion efficiency even with very light loads. Since the Output Voltage pin is also used as the device Supply Voltage, the versions with higher output voltage present an higher internal supply voltage that results in lower power switch  $R_{DS(on)}$ , slightly greater output power and higher efficiency. Moreover, bootstrapping allows the input voltage to sag to 0.6V (at  $I_{OUT} = 1mA$ ) once the system is started. If the input voltage exceeds the output voltage, the output will follow the input, however, the input or output voltage must not be forced above 5.5V.

## APPLICATION INFORMATION

### INPUT/OUTPUT CAPACITOR SELECTION

The Output Ripple Voltage, as well as the Efficiency, is strictly related to the behavior of these elements. The output ripple voltage is the product of the peak inductor current and the output capacitor Equivalent Series Resistance (ESR). Best performances are obtained with good high frequency characteristics capacitors and low ESR. The best compromise for the value of the Output Capacitance is 47 $\mu$ F Tantalum Capacitor; Lower values may cause higher Output Ripple Voltage and lower Efficiency without compromising the functionality of the device.

An Input Capacitor is required to compensate, if present, the series impedance between the Supply Voltage Source and the Input Voltage of the Application.

### INDUCTOR SELECTION

A 47 $\mu$ H inductor is recommended for most APE2901 applications. However, the inductance value is not critical, and the APE2901 will work with inductors in the 33 $\mu$ H to 120 $\mu$ H.



---

## **APPLICATION INFORMATION**

### **DIODE SELECTION**

Schottky diodes with higher current ratings usually have lower forward voltage drop, larger diode capacitance and fast reverse recovery, it is the ideal choices for APE2901 applications. The forward voltage drop of a Schottky diode represents the conduction losses in the system, while the diode capacitance ( $C_T$  or  $C_D$ ) represents the switching losses. For diode selection, both forward voltage drop and diode capacitance need to be considered.

### **PCB LAYOUT GUIDE**

When laying out the PC board, the following suggestions should be taken to ensure proper operation of the APE2901. These items are also illustrated graphically in below.

1. The power traces, including the GND trace, the SW trace and the  $V_{CC}$  trace should be kept short, direct and wide to allow large current flow. Put enough multiply-layer pads when they need to change the trace layer.
2. Do not trace signal line under inductor.



TYPICAL PERFORMANCE CHARACTERISTICS

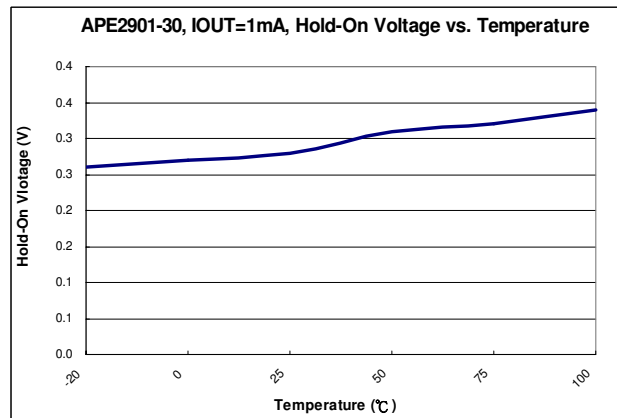
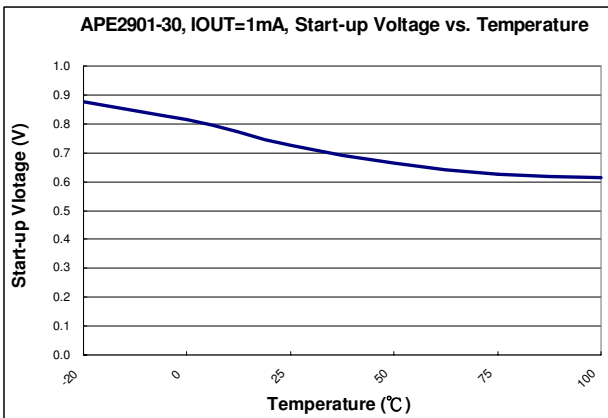
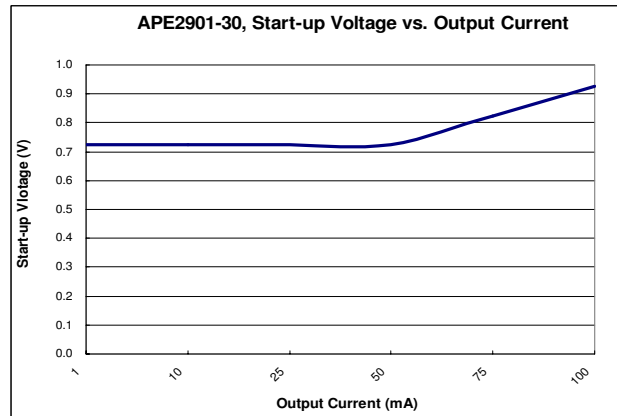
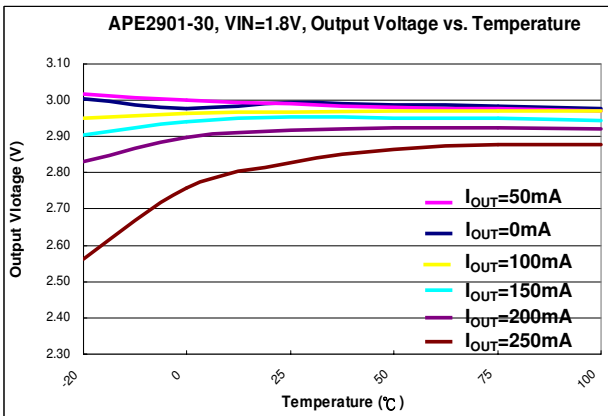
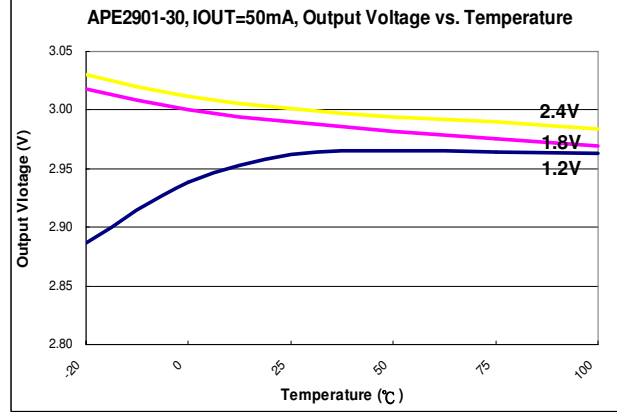
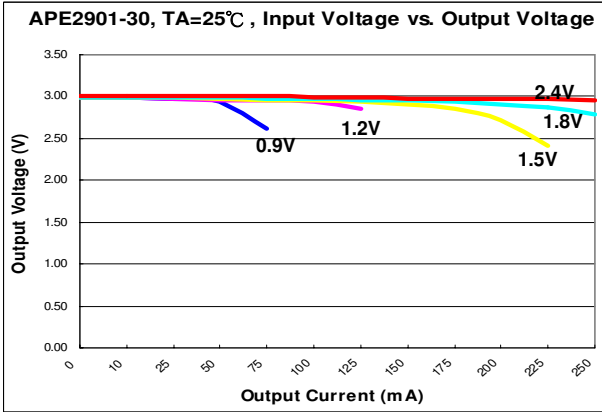



TYPICAL PERFORMANCE CHARACTERISTICS

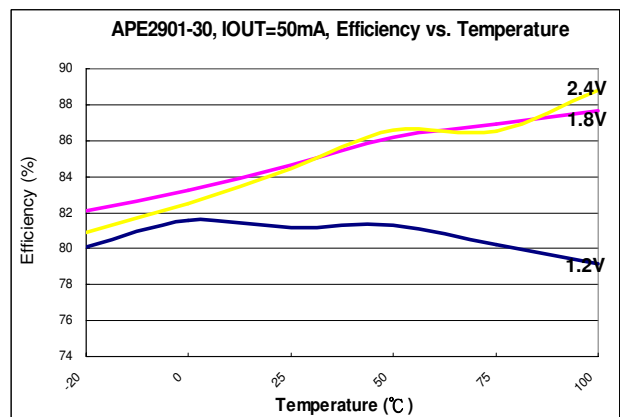
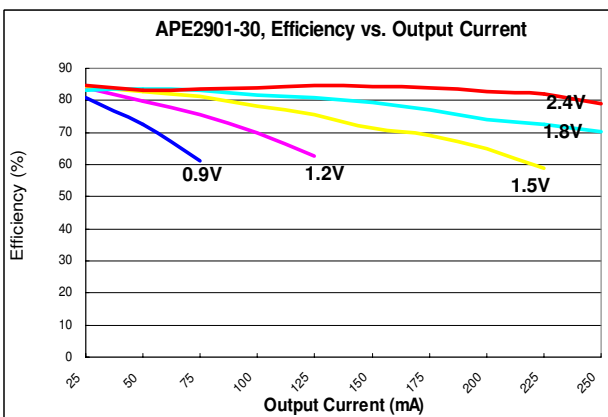
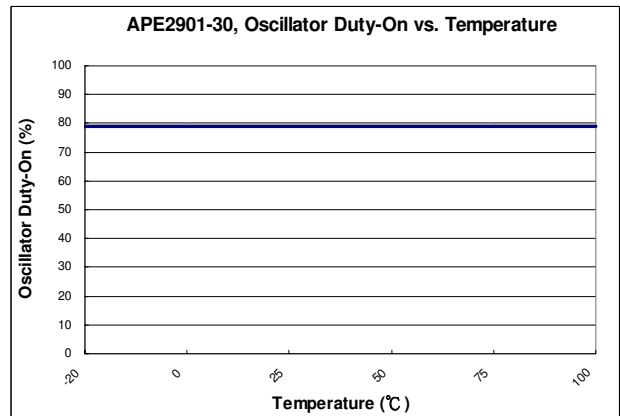
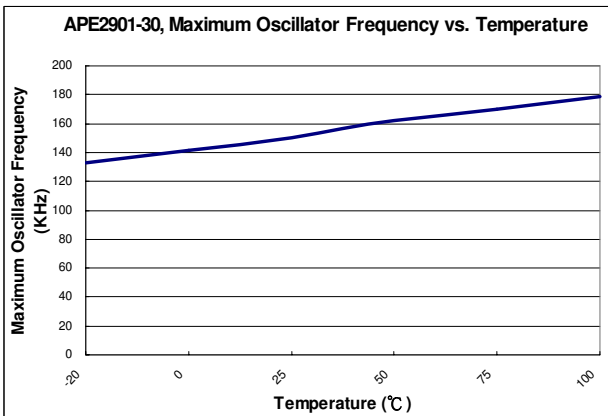
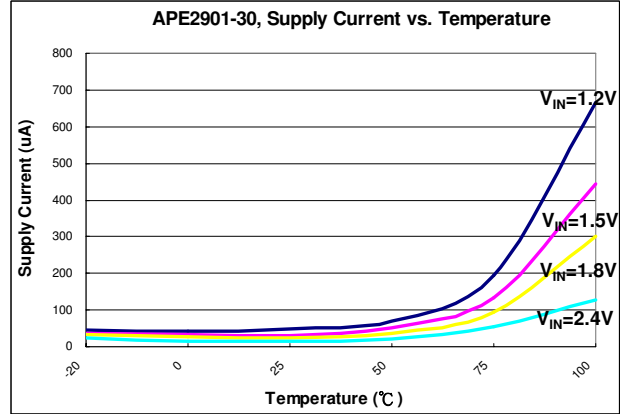
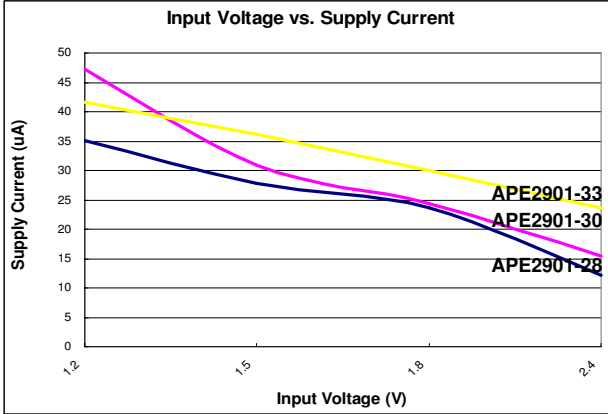



TYPICAL PERFORMANCE CHARACTERISTICS

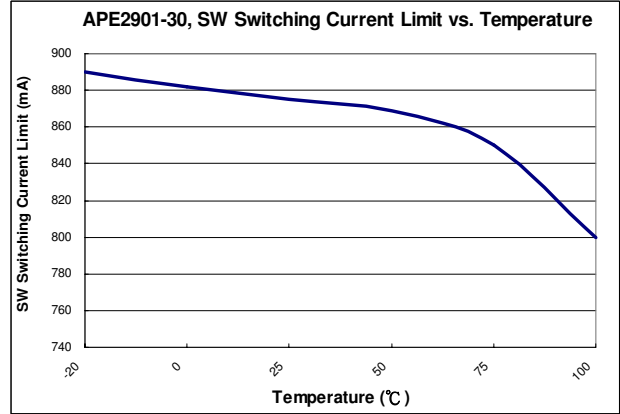
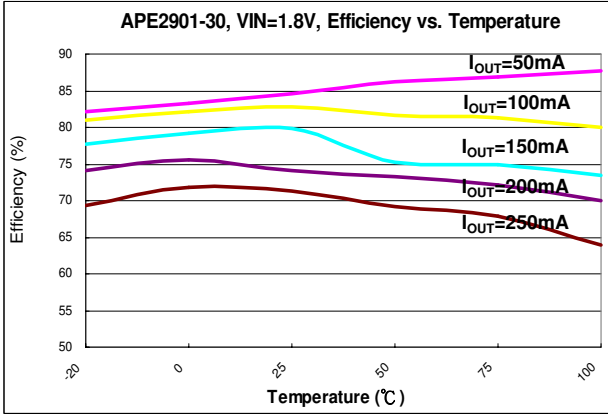



**Package Outline : SOT-23-5L**

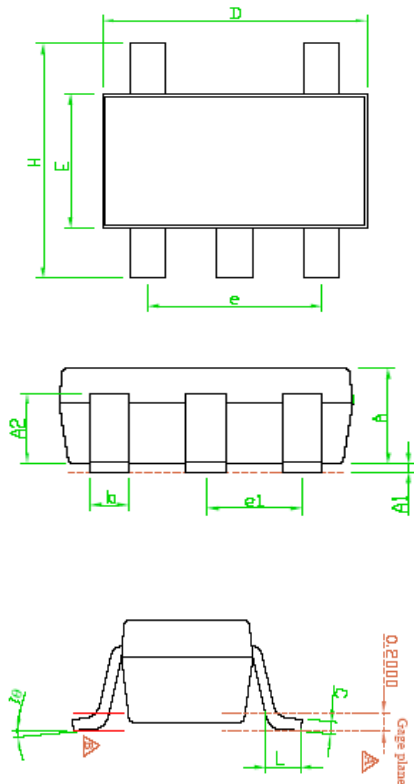

SYMBOLS	Millimeters		
	MIN	NOM	MAX
A	1.00	1.10	1.30
A1	0.00	---	0.10
A2	0.70	0.80	0.90
b	0.35	0.40	0.50
C	0.10	0.15	0.25
D	2.70	2.90	3.10
E	1.50	1.60	1.80
e	---	1.90(TYP)	---
H	2.60	2.80	3.00
L	0.37	---	---
$\theta 1$	1°	5°	9°
e2	---	0.95(TYP)	---

- Note 1 : Package Body Sizes Exclude Mold Flash Protrusions or Gate Burrs.
- Note 2 : Tolerance  $\pm 0.1000$  mm(4mil) Unless Otherwise Specified.
- Note 3 : Coplanarity : 0.1000 mm
- Note 4 : Dimension L Is Measured in Gage plane.

**Part Marking Information & Packing : SOT-23 -5L**

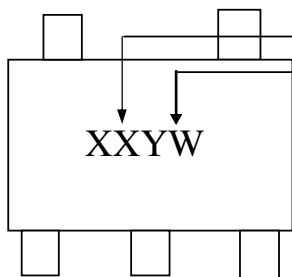

Part Number : XX (Identification Code)  
 Date Code : YW  
 Y : Year W : Week

Part Number	Identification Code	Part Number	Identification Code
APE2901Y5-2.2V	To	APE2901Y5-3.8V	TN
APE2901Y5-2.5V	TA	APE2901Y5-3.9V	TO
APE2901Y5-2.6V	TB	APE2901Y5-4.0V	TP
APE2901Y5-2.7V	TC	APE2901Y5-4.1V	TQ
APE2901Y5-2.8V	TD	APE2901Y5-4.2V	TR
APE2901Y5-2.9V	TE	APE2901Y5-4.3V	TS
APE2901Y5-3.0V	TF	APE2901Y5-4.4V	TT
APE2901Y5-3.1V	TG	APE2901Y5-4.5V	TU
APE2901Y5-3.2V	TH	APE2901Y5-4.6V	TV
APE2901Y5-3.3V	TI	APE2901Y5-4.7V	TW
APE2901Y5-3.4V	TJ	APE2901Y5-4.8V	TX
APE2901Y5-3.5V	TK	APE2901Y5-4.9V	TY
APE2901Y5-3.6V	TL	APE2901Y5-5.0V	TZ
APE2901Y5-3.7V	TM		



**Package Outline : SOT-23**

SYMBOLS	Millimeters		
	MIN	NOM	MAX
A	1.00	1.15	1.30
A1	0.00	--	0.10
A2	0.10	0.15	0.25
D1	0.30	0.40	0.50
e	1.70	2.00	2.30
D	2.70	2.90	3.10
E	2.40	2.65	3.00
E1	1.40	1.50	1.60

1.All Dimension Are In Millimeters.  
2.Dimension Does Not Include Mold Protrusions.

**Part Marking Information & Packing : SOT-23**

Date Code : YY  
 YY:2004,2008,2012...  
 YY:2003,2007,2011...  
 YY:2002,2006,2010...  
 YY:2001,2005,2009...  
 Part Number : XX (Identification Code)

Part Number	Identification Code	Part Number	Identification Code
APE2901N-2.2V	To	APE2901N-3.8V	TN
APE2901N-2.5V	TA	APE2901N-3.9V	TO
APE2901N-2.6V	TB	APE2901N-4.0V	TP
APE2901N-2.7V	TC	APE2901N-4.1V	TQ
APE2901N-2.8V	TD	APE2901N-4.2V	TR
APE2901N-2.9V	TE	APE2901N-4.3V	TS
APE2901N-3.0V	TF	APE2901N-4.4V	TT
APE2901N-3.1V	TG	APE2901N-4.5V	TU
APE2901N-3.2V	TH	APE2901N-4.6V	TV
APE2901N-3.3V	TI	APE2901N-4.7V	TW
APE2901N-3.4V	TJ	APE2901N-4.8V	TX
APE2901N-3.5V	TK	APE2901N-4.9V	TY
APE2901N-3.6V	TL	APE2901N-5.0V	TZ
APE2901N-3.7V	TM		



**Package Outline & Packing : SOT-89**

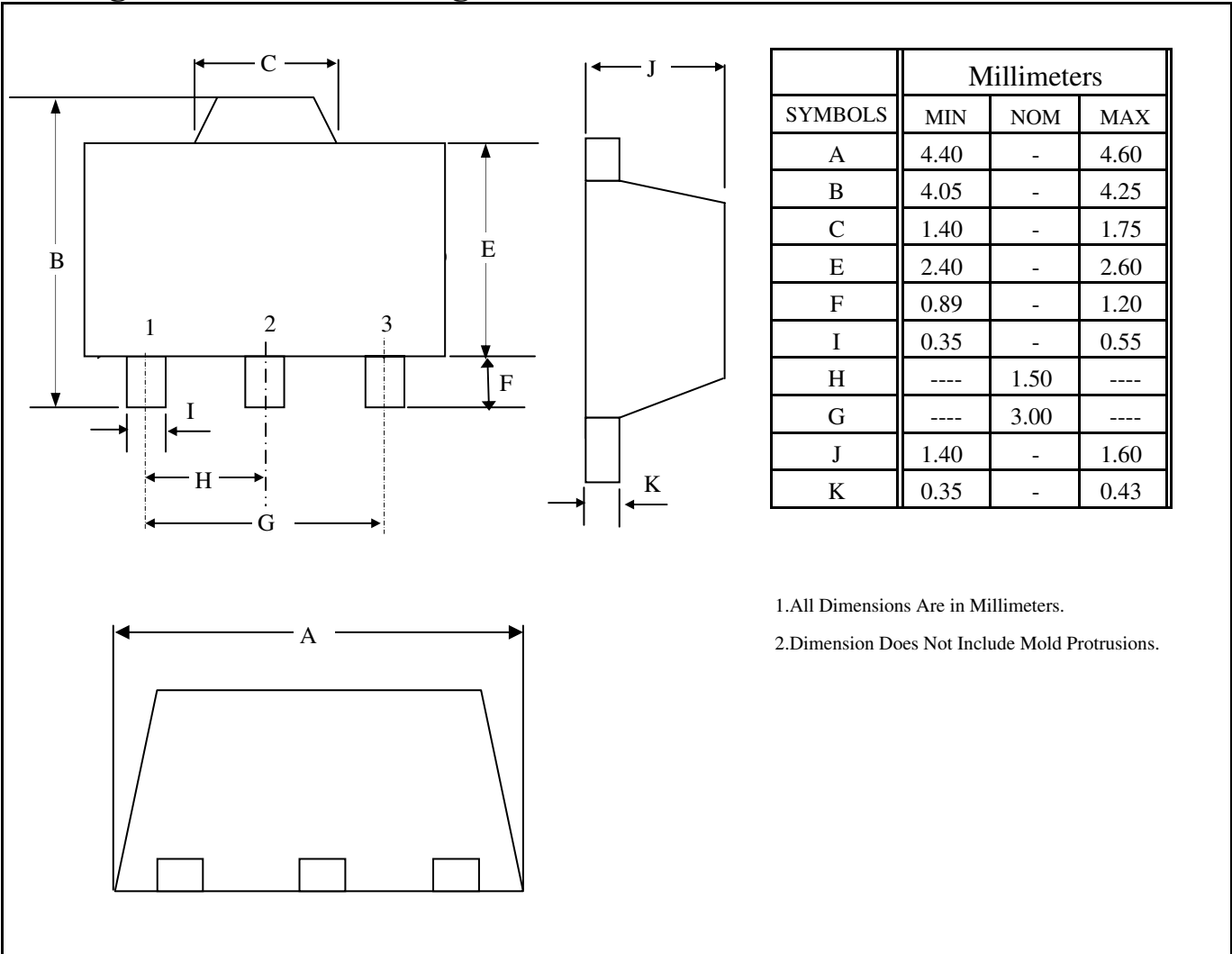

**Part Marking Information : SOT-89**

