



200KHz, 1.5A PWM Buck DC/DC Converter

❖ **GENERAL DESCRIPTION**

The APE1720 series are monolithic IC designed for a step-down DC/DC converter, and own the ability of driving a 1.5A load without additional transistor. It saves board space. The external shutdown function can be controlled by logic level and then come into standby mode. The internal compensation makes feedback control having good line and load regulation without external design. Regarding protected function, thermal shutdown is to prevent over temperature operating from damage, and current limit is against over current operating of the output switch. If current limit function occurs and V_{FB} is down below 0.5V, the switching frequency will be reduced. The APE1720 series operates at a switching frequency of 200KHz thus allow smaller sized filter components than what would be needed with lower frequency switching regulators. Other features include a guaranteed +3% tolerance on output voltage under specified input voltage and output load conditions, The chips are available in a standard 8-lead SOP package.

❖ **FEATURES**

- Output voltage: adjustable output version.
- Adjustable version output voltage range: 0.75V to 22V+3%.
- 200KHz fixed switching frequency.
- Voltage mode non-synchronous PWM control.
- Thermal-shutdown and current-limit protection.
- ON/OFF shutdown control input.
- Operating voltage can be up to 24V.
- Output load current: 1.5A.
- SOP-8L Pb-Free packages.
- Low power standby mode.
- Built-in switching transistor on chip.



❖ BLOCK DIAGRAM

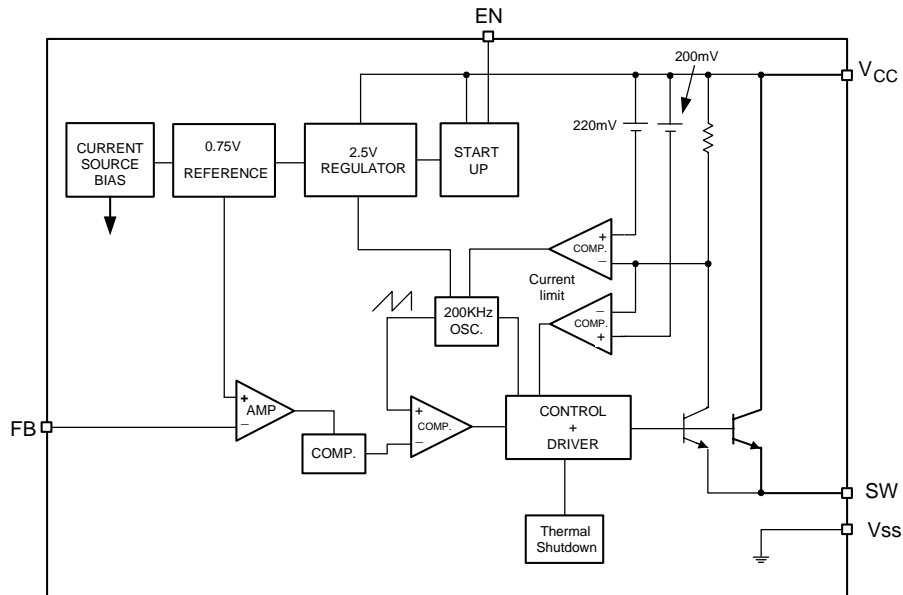

❖ PIN ASSIGNMENT

The package of APE1720 is SOP-8L; the pin assignment is given by:

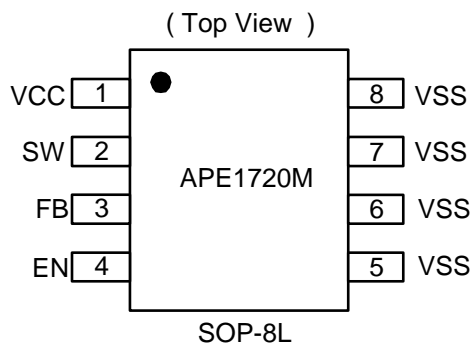

| Name | Description |
|-----------------------|---|
| V_{CC} | Operating voltage input |
| SW | Switching output |
| FB | Output voltage feedback control |
| EN | ON/OFF Shutdown HIGH : ON, LOW : OFF |
| V_{SS} | GND pin |

❖ ORDER/MARKING INFORMATION

| Order Information | Top Marking |
|--|---|
| <p>APE1720X</p> <p>Package Type M: SOP-8L</p> | <p>1720M → Part number</p> <p>YWWSSS → ID code: internal</p> <p>WW: 01~52</p> <p>Year: 7 = 2007</p> |



❖ **Absolute Maximum Ratings**

| Characteristics | Symbol | Rating | Unit |
|---|---------------|-----------------------------|------|
| Maximum Supply Voltage | V_{CC} | +26 | V |
| ON/OFF Pin Input Voltage | V_{EN} | -0.3 to V_{CC} | V |
| Feedback Pin Voltage | V_{FB} | -0.3 to 12 | V |
| Output Voltage to Ground | V_{OUT} | -0.8 | V |
| Power Dissipation Internally limited | PD | $(T_J - T_A) / \theta_{JA}$ | W |
| Storage Temperature Range | T_{ST} | -65 to +150 | °C |
| Operating Temperature Range | T_{OP} | -20 to +125 | °C |
| Operating Supply Voltage | V_{OP} | +4.0 to +24 | V |
| Thermal Resistance from Junction to case | θ_{JC} | 20 | °C/W |
| Thermal Resistance from Junction to ambient | θ_{JA} | 55 | °C/W |

Note : θ_{JA} is measured with the PCB copper area(need connect to V_{SS} pins) of approximately 1.5 in² (Multi-layer).

❖ **Electrical Characteristics** (Unless otherwise specified, $T_a=25^\circ\text{C}$, $V_{CC}=12\text{V}$, $I_{LOAD} = 0.2\text{A}$)

| Characteristics | Symbol | Conditions | Min | Typ | Max | Units |
|---|-----------|--|-------|-------|-------|-------|
| Feedback Voltage | V_{FB} | $I_{OUT}=0.2\text{A}$ | 0.728 | 0.750 | 0.773 | V |
| Quiescent Current | I_Q | $V_{FB}=1.2\text{V}$ force driver off | | 4 | 8 | mA |
| Feedback bias current | I_{FB} | $I_{OUT}=0.1\text{A}$ | | -10 | -50 | nA |
| Shutdown supply Current | I_{SD} | $V_{EN}=0\text{V}$ | - | 2 | 10 | uA |
| Oscillator frequency | F_{OSC} | | 140 | 200 | 260 | KHz |
| Oscillator frequency of short circuit protect | F_{SCP} | (Adjustable) When $V_{FB}<0.5\text{V}$ | | 80 | | KHz |
| Max. Duty Cycle (ON) | DC | $V_{FB}=1.2\text{V}$ force driver off | | 0 | | % |
| Min. Duty Cycle (OFF) | | $V_{FB}=0\text{V}$ force driver on | | 100 | | |
| Current limit | I_{CL} | Pear current, No outside circuit $V_{FB}=0\text{V}$ force driver on | 1.8 | | | A |
| Saturation voltage | V_{SAT} | $I_{OUT}=1.5\text{A}$, No outside circuit $V_{FB}=0\text{V}$ force driver on | | 1.2 | 1.5 | V |
| SW pin=0V | I_{SWL} | No outside circuit $V_{FB}=1.0\text{V}$ force driver off | | | -200 | uA |
| SW pin=-0.8V | | $V_{CC}=24\text{V}$ force driver off | | -5 | | mA |
| EN pin logic input threshold voltage | V_{IH} | High (regulator ON) | - | 1.2 | 2.0 | V |
| | V_{IL} | Low (regulator OFF) | 0.5 | | - | |
| EN pin logic input current | I_H | $V_{EN}=2.5\text{V}$ (ON) | - | 20 | - | uA |
| EN pin input current | I_L | $V_{EN}=0.3\text{V}$ (OFF) | - | -5 | - | |
| Thermal shutdown Temp | TSD | | | 135 | | °C |



❖ Application Circuit

(1) Adjustable Output Voltage Version

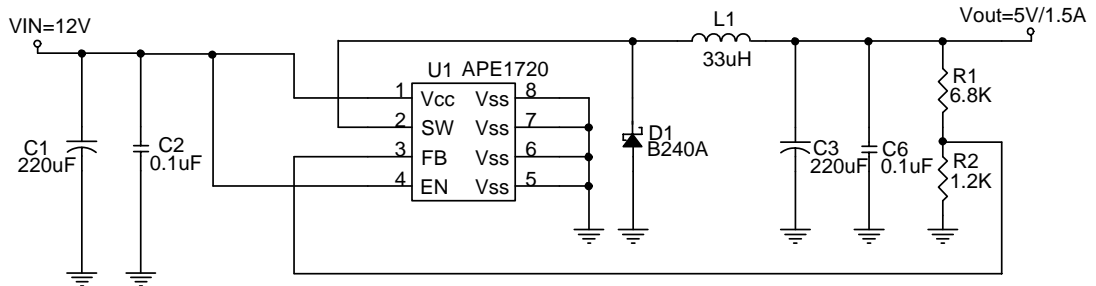

(2) EN PIN With Delayed Startup

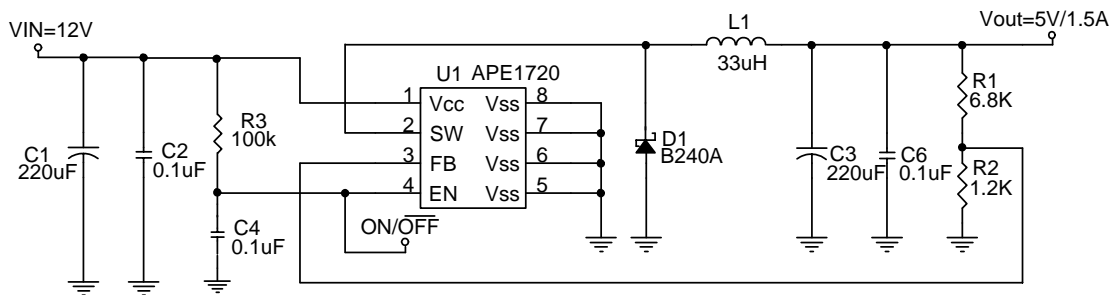

$$V_{out} = V_{FB} \times \left(1 + \frac{R1}{R2}\right), V_{FB} = 0.75V, R2 = 0.75K \sim 4K$$

Table 1 Resistor select for output voltage setting

| V _{OUT} | R2 | R1 |
|------------------|------|------|
| 5V | 1.2K | 6.8K |
| 3.3V | 2K | 6.8K |
| 2.5V | 2K | 4.7K |
| 1.8V | 2K | 3K |
| 1.5V | 2K | 2K |
| 1.3V | 2K | 1.5K |
| 1.2V | 2K | 1.2K |

❖ Function Descriptions

Pin Functions

V_{cc}

This is the positive input supply for the IC switching regulator. A suitable input bypass capacitor must be presented at this pin to minimize voltage transients and to supply the switching currents needed by the regulator.

V_{ss}

Circuit ground.

SW

Internal switch. The voltage at this pin switches between $(+V_{CC} - V_{SAT})$ and approximately $-0.5V$, with a duty cycle of approximately V_{OUT} / V_{CC} . To minimize coupling to sensitive circuitry, the PC board copper area connected to this pin should be minimized.

Feedback

Senses the regulated output voltage to complete the feedback loop.

EN

Allows the switching regulator circuit to be shutdown using logic level signals thus dropping the total input supply current to approximately 10uA. Pulling this pin below a threshold voltage of approximately 0.5V shuts the regulator down, and pulling this pin above 2.0V (up to a maximum of V_{cc}) turns the regulator on.

Thermal Considerations

The SOP-8 package needs a heat sink under most conditions. The size of the heat sink depends on the input voltage, the output voltage, the load current and the ambient temperature. The APE1720 junction temperature rises above ambient temperature for a 1.5A load and different input and output voltages.

For the best thermal performance, wide copper traces and generous amounts of PCB copper (need connect to the V_{SS} pins) should be used in the board layout, (One exception is the SW pin, which should not have large areas of copper.) Large areas of copper provide the best transfer of heat (lower thermal resistance) to the surrounding air, and moving air lowers the thermal resistance even further.



❖ Typical Characteristics

VFB VS VIN

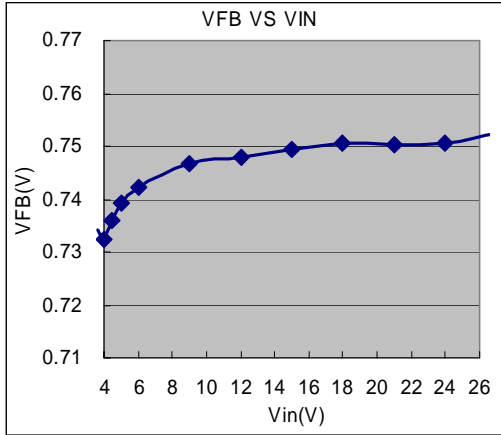

ICCQ VS VIN

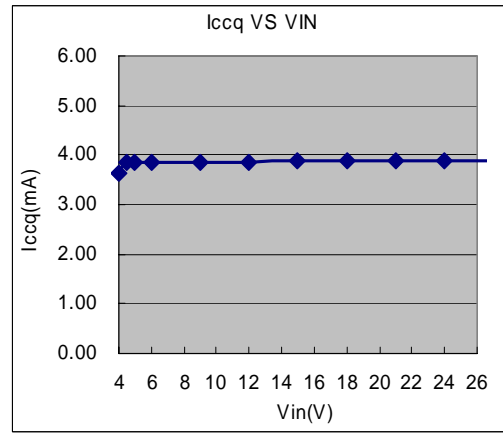

FOSC VS VIN

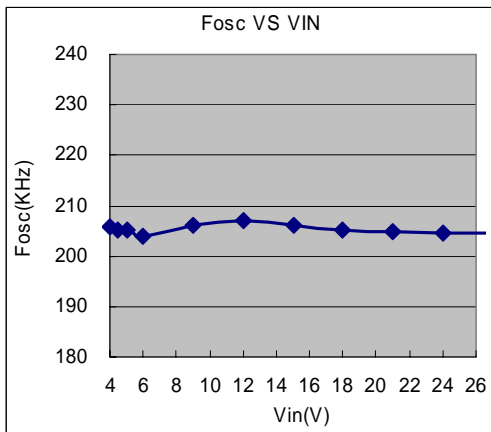

FOSC VS TEMPERATURE

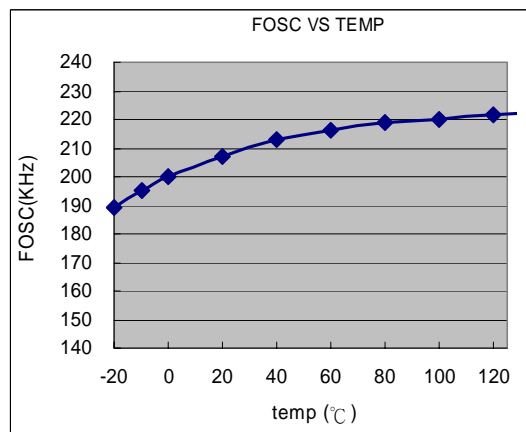

VFB VS TEMPERATURE

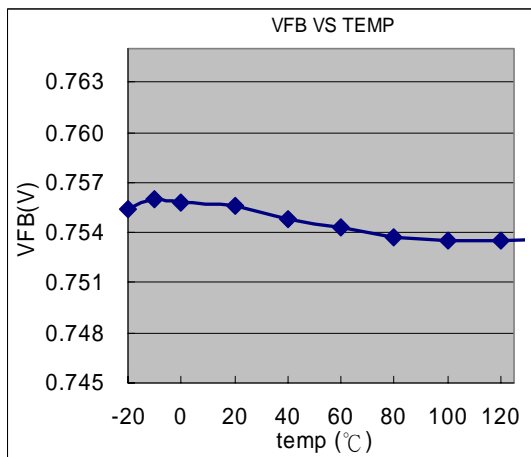

ICCQ VS TEMPERATURE

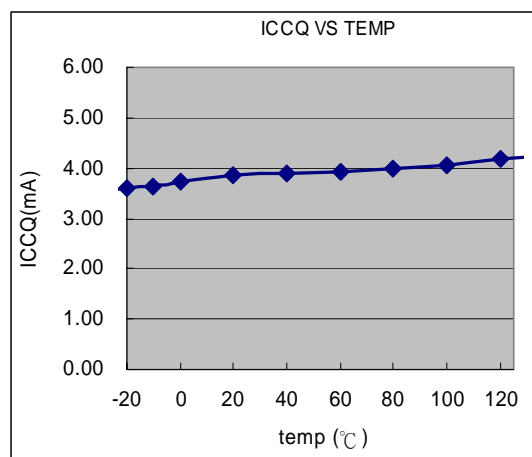



❖ Typical Characteristics

Output Ripple
($V_{IN}=12V, V_{OUT}=3.3V, I_{OUT}=1.5A$)

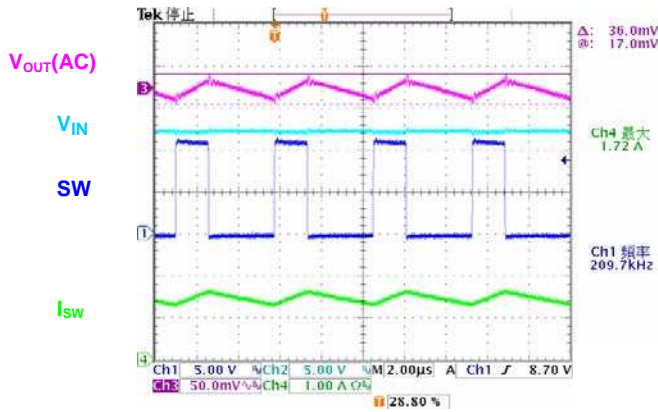

Power on test wave
($V_{IN}=12V, V_{OUT}=3.3V, I_{OUT}=1.5A$)

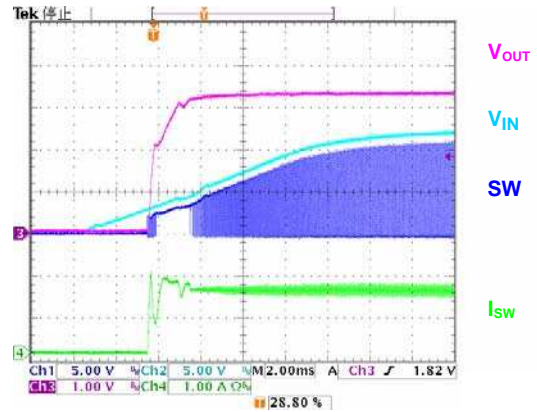

Load Transient Response
($V_{IN}=12V, V_{OUT}=3.3V, I_{OUT}=0.1\sim 1.5A$)

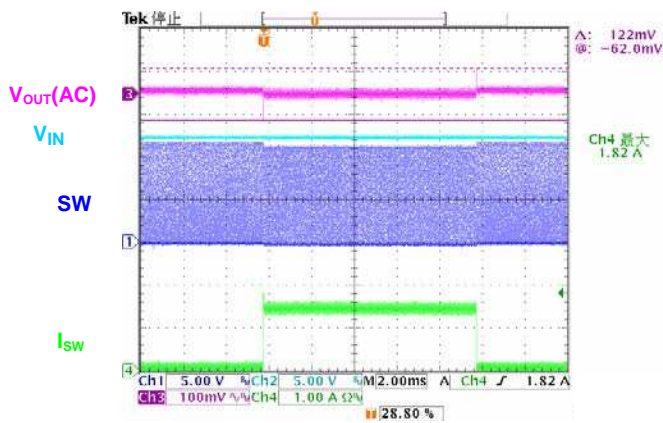

EN PIN on test wave
($V_{IN}=12V, V_{OUT}=3.3V, I_{OUT}=1.5A$)

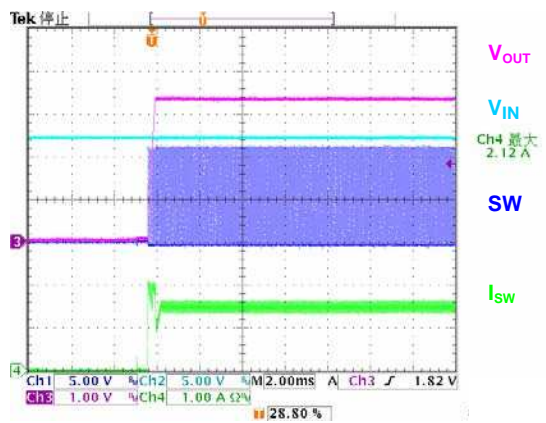

Efficiency
($V_{IN}=12V, V_{OUT}=5V$)

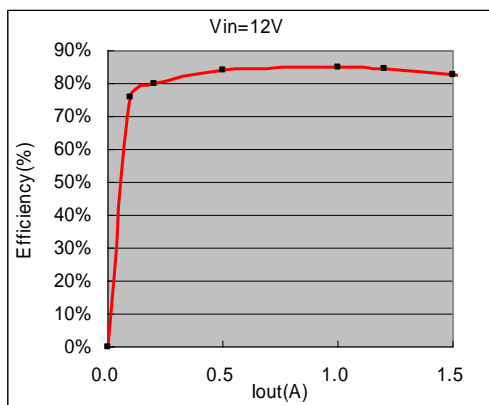

Efficiency
($V_{IN}=12V$)

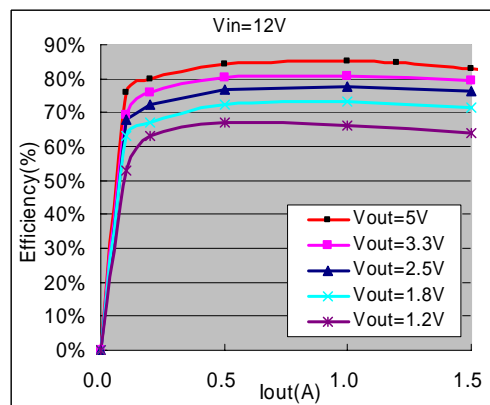



Package Outline : SOP-8L

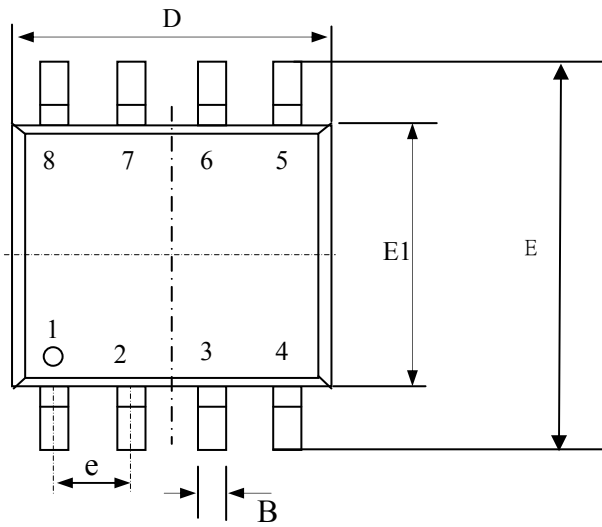

| SYMBOLS | Millimeters | | |
|----------|-------------|------|------|
| | MIN | NOM | MAX |
| A | 1.35 | 1.55 | 1.75 |
| A1 | 0.10 | 0.18 | 0.25 |
| B | 0.33 | 0.41 | 0.51 |
| C | 0.19 | 0.22 | 0.25 |
| D | 4.80 | 4.90 | 5.00 |
| E1 | 3.80 | 3.90 | 4.00 |
| E | 5.80 | 6.15 | 6.50 |
| L | 0.38 | 0.71 | 1.27 |
| θ | 0 | 4.00 | 8.00 |
| e | 1.27 TYP | | |

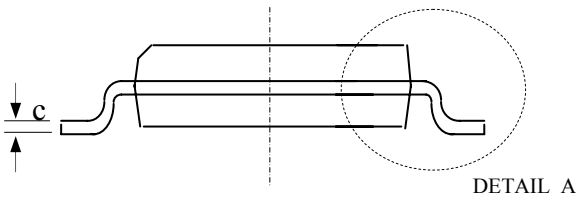
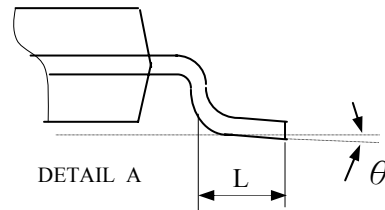
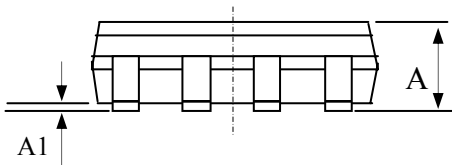

1. All Dimension Are In Millimeters.
2. Dimension Does Not Include Mold Protrusions.

Part Marking Information & Packing : SOP-8L

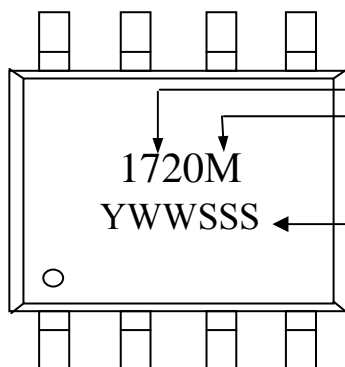

Part Number
Package Code

Date Code (YWWSSS)

Y : Last Digit Of The Year

WW : Week

SSS : Sequence