



FEATURES

- Output Voltage : Adjustable Output Version.
- Adjustable Version Output Voltage Range : 0.745V to 24V.
- 200KHz Fixed Switching Frequency.
- Thermal-shutdown and Current-limit Protection.
- ON/OFF Shutdown Control Input.
- Short Circuit Protect (SCP).
- Operating Voltage can be up to 26V.
- Output Load Current : 1A.
- Low Power Standby Mode.
- Built-in Switching Transistor on Chip.
- SOT-23-5L and SO-8 packages.

DESCRIPTION

The APE1723 series are monolithic IC designed for a step-down DC/DC converter, and own the ability of driving a 1A load without additional transistor. It saves board space. The external shutdown function can be controlled by logic level and then come into standby mode. The internal compensation makes feedback control having good line and load regulation without external design. Regarding protected function, thermal shutdown is to prevent over temperature operating from damage, and current limit is against over current operating of the output switch. If the APE1723's VFB is down below 0.5V, the switching frequency will be reduced. The APE1723 operates at a switching frequency of 200KHz thus allow smaller sized filter components. Other features include a guaranteed +3% tolerance on output voltage under specified input voltage and output load conditions, The chips are available in SOT-23-5L and SO-8 packages.

TYPICAL APPLICATION

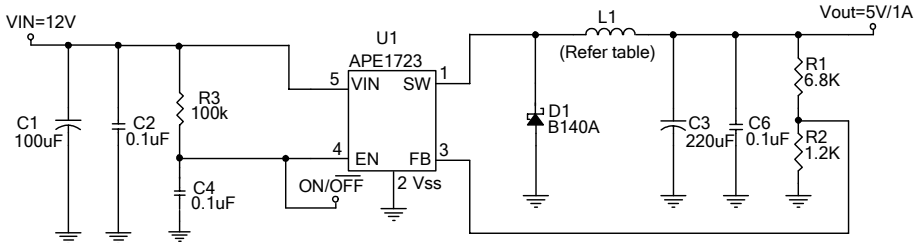

$$V_{OUT} = V_{FB} \times (1 + R1/R2), V_{FB} = 0.745V, R2 = 0.75K \sim 4 K$$

Table 1 Resistor select for output voltage setting

V _{OUT}	R2	R1
5V	1.2K	6.8K
3.3V	2.4K	8.2K
2.5V	2K	4.7K
1.8V	3.3K	4.7K
1.5V	2K	2K
1.3V	2K	1.5K
1.2V	2K	1.2K

L1 recommend value (V _{IN} =12V, I _{OUT} =1A)				
V _{OUT}	1.8V	2.5V	3.3V	5V
L1 Value	33uH	33uH	47uH	47uH

ABSOLUTE MAXIMUM RATINGS (at $T_A=25^\circ\text{C}$)

Maximum Supply Voltage(V_{IN})	-----	+30V
Feedback PIN Voltage(V_{FB})	-----	-0.3V to 12V
ON/OFF PIN Voltage(V_{EN})	-----	-0.3V to V_{IN}
Output Voltage to Ground(V_{OUT})	-----	-0.8V
Power Dissipation(P_D)	-----	$(T_J-T_A)/R_{thJA}$ W
Storage Temperature Range(T_{ST})	-----	-65°C To 150°C
Operating Junction Temperature Range(T_{OPJ})	-----	-40°C To 125°C
Operating Supply Voltage(V_{OP})	-----	+4.5V to 26V
Thermal Resistance from Junction to Case(R_{thJC})		
	SO-8	50°C/W
	SOT-23-5L	180°C/W
Thermal Resistance from Junction to Ambient(R_{thJA})		
	SO-8	120°C/W
	SOT-23-5L	250°C/W

Note. R_{thJA} is measured with the PCB copper area(need connect to V_{SS} pins) of approx. 1.5 in^2 (multi-layers)

ORDERING/PACKAGE INFORMATION

APE1723X
 Package Type
 Y5 : SOT-23-5L
 M : SO-8

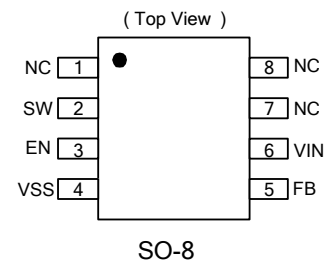
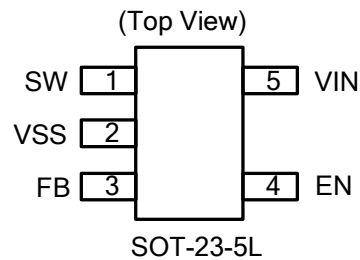
ELECTRICAL SPECIFICATIONS

($V_{CC}=12\text{V}$, $V_{OUT}=3.3\text{V}$, $I_{LOAD}=0.3\text{A}$, $T_A=25^\circ\text{C}$, unless otherwise specified)

Parameter	SYM	TEST CONDITION	MIN	TYP	MAX	UNITS
Feedback Voltage	V_{FB}	$I_{OUT}=0.3\text{A}$	0.723	0.745	0.767	V
Quiescent Current	I_Q	$V_{FB}=1.2\text{V}$ force driver off	-	3.5	6	mA
Feedback Bias Current	I_{FB}	$I_{OUT}=0.1\text{A}$	-	-10	-50	nA
Shutdown Supply Current	I_{SD}	$V_{EN}=0\text{V}$	-	2	10	uA
Oscillator Frequency	F_{OSC}		140	200	260	KHz
Oscillator Frequency of Short Circuit Protect	F_{SCP}	(Adjustable) When $V_{FB}<0.5\text{V}$	-	50	-	KHz
Max. Duty Cycle (ON)	DC	$V_{FB}=1.2\text{V}$ force driver off	-	0	-	%
Min. Duty Cycle (OFF)		$V_{FB}=0\text{V}$ force driver on	-	100	-	
Current Limit	I_{LIMIT}	Pear current, No outside circuit $V_{FB}=0\text{V}$ force driver on	1.2	-	-	A
Saturation Voltage	V_{SAT}	$I_{OUT}=1\text{A}$, No outside circuit $V_{FB}=0\text{V}$ force driver on	-	1.2	1.5	V



ELECTRICAL SPECIFICATIONS(Cont.)

Parameter	SYM	TEST CONDITION	MIN	TYP	MAX	UNITS
SW Pin=0V	SW Pin Leakage current	$V_{IN}=26V$, No outside circuit $V_{FB}=1.0V$ force driver off	-	-	-200	μA
SW Pin=-0.8V			-	-5	-	mA
EN Pin Logic Input Threshold Voltage	V_{IH}	High (regulator ON)	-	-	2	V
	V_{IL}	Low (regulator OFF)	0.5	-	-	
EN Pin Logic Input Current	I_H	$V_{EN}=2.5V$ (ON)	-	20	-	μA
EN Pin Input Current	I_L	$V_{EN}=0.3V$ (OFF)	-	-5	-	
Thermal Shutdown Temp	TSD		-	145	-	$^{\circ}C$

PIN DESCRIPTIONS

PIN SYMBOL	PIN DESCRIPTION
V_{SS}	GND Pin
FB	Feedback Pin
EN	Power -Off Pin H : Normal Operation(Step-down) L : Step-down Operation Stopped (All circuits deactivated)
SW	Switch Output
V_{IN}	Operating Voltage Input
NC	No Connect Pin

BLOCK DIAGRAM

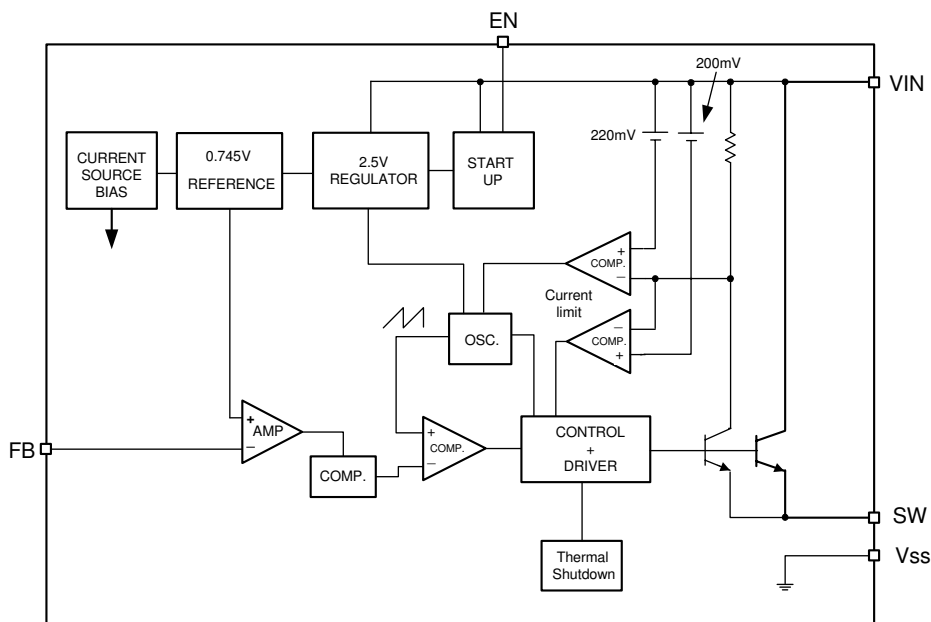



FUNCTION PIN DESCRIPTION

Pin Functions

VIN

This is the positive input supply for the IC switching regulator. A suitable input bypass capacitor must be presented at this pin to minimize voltage transients and to supply the switching currents needed by the regulator.

VSS

Circuit ground.

SW

Internal switch. The voltage at this pin switches between $(+V_{IN} - V_{SAT})$ and approximately $-0.5V$, with a duty cycle of approximately V_{OUT} / V_{IN} . To minimize coupling to sensitive circuitry, the PC board copper area connected to this pin should be minimized.

FB

Senses the regulated output voltage to complete the feedback loop.

EN

Allows the switching regulator circuit to be shutdown using logic level signals thus dropping the total input supply current to approximately 10uA. Pulling this pin below a threshold voltage of approximately 0.5V shuts the regulator down, and pulling this pin above 2.0V (up to a maximum of V_{IN}) turns the regulator on.



TYPICAL PERFORMANCE CHARACTERISTICS

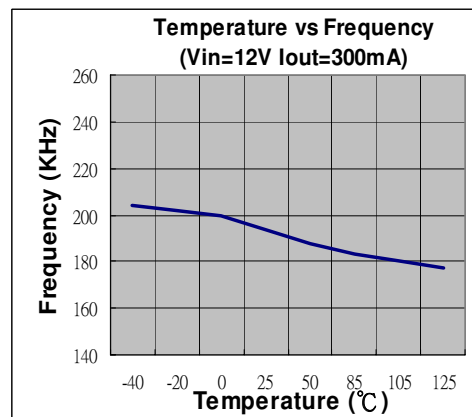
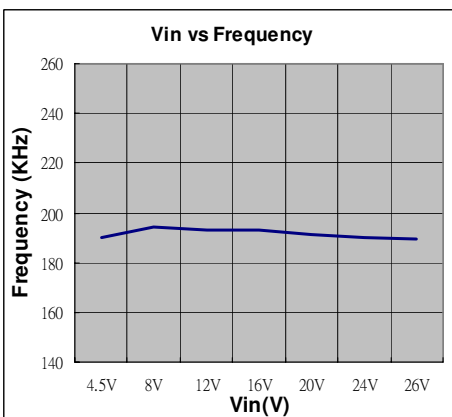
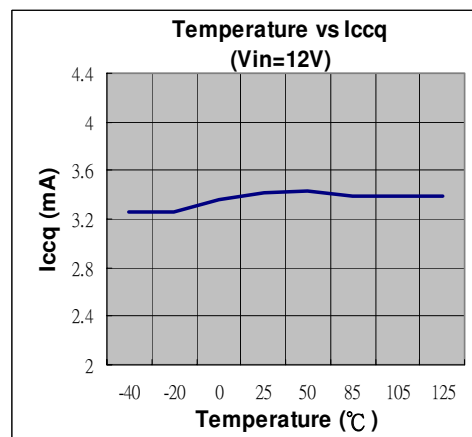
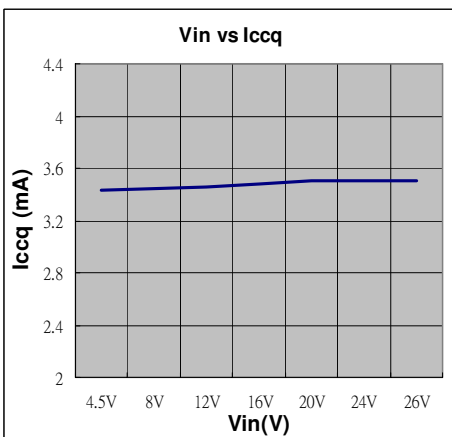
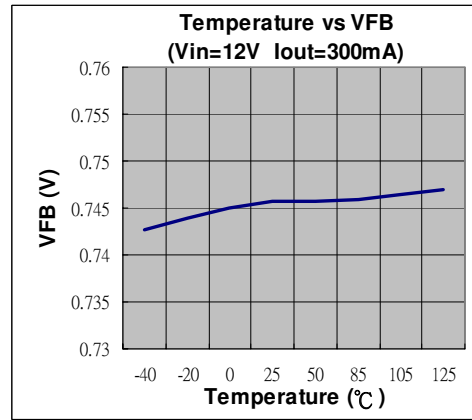
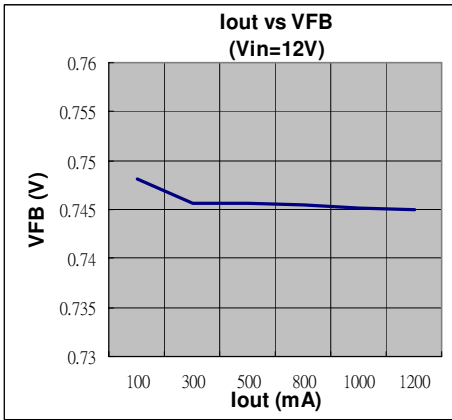



TYPICAL PERFORMANCE CHARACTERISTICS

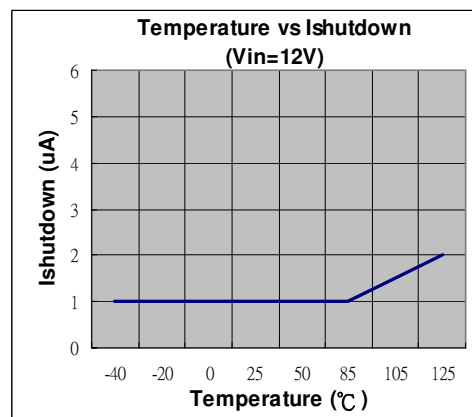
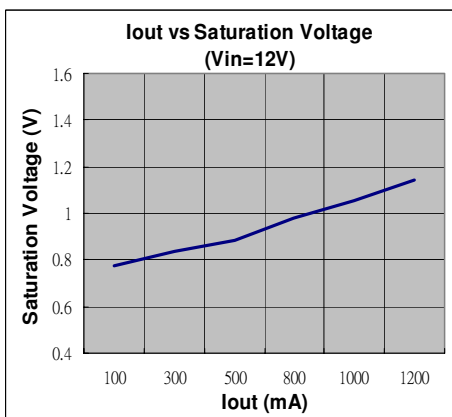
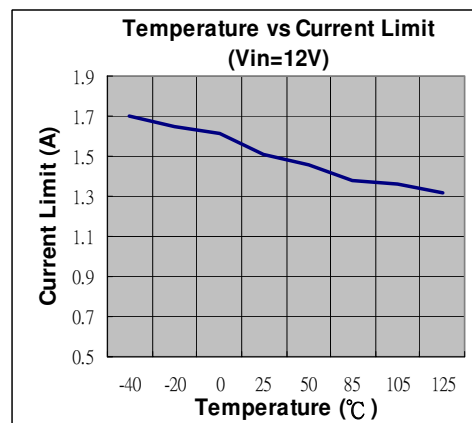
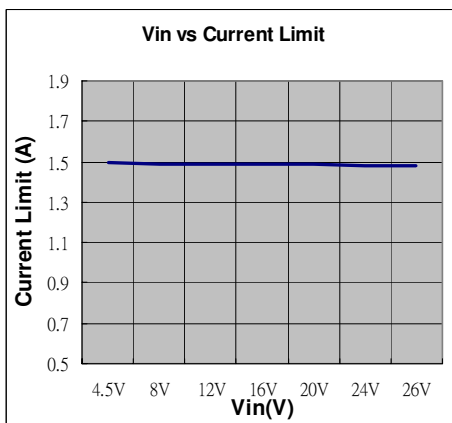
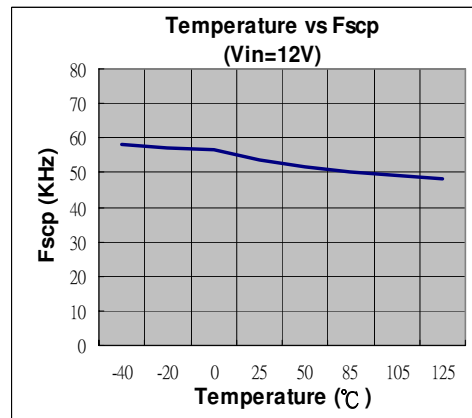
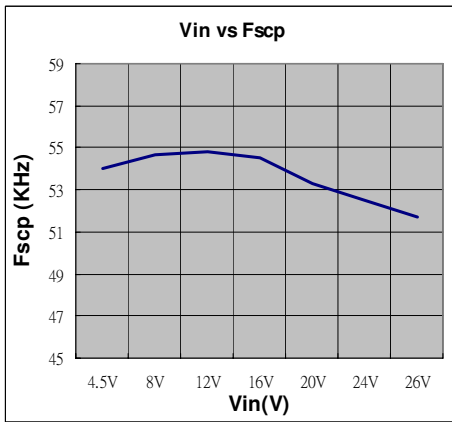



TYPICAL PERFORMANCE CHARACTERISTICS

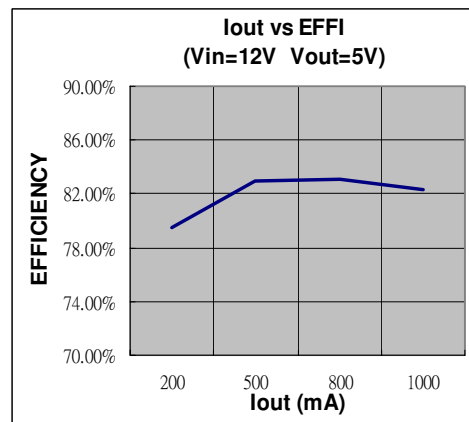
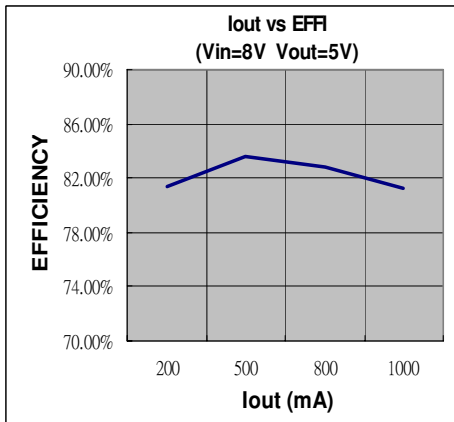

Output Ripple (12V→5V @1A)

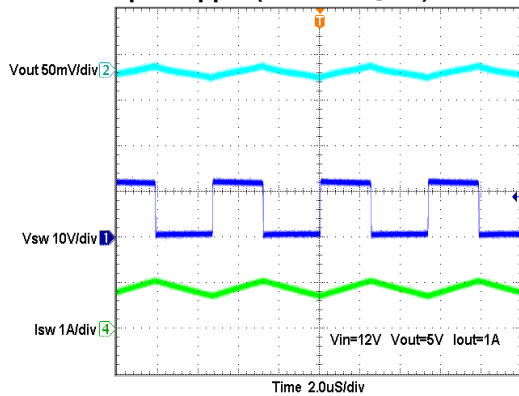

Output Ripple (24V→5V @1A)

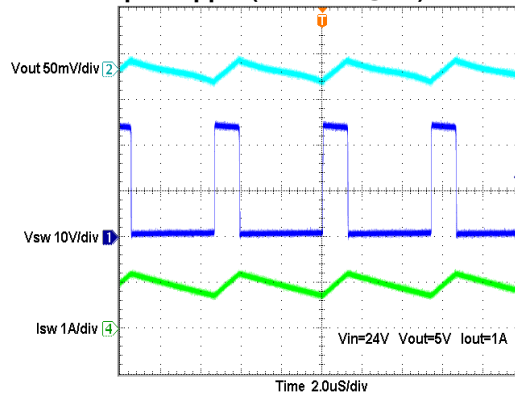

EN Off→ON Test (12V→5V @1A)

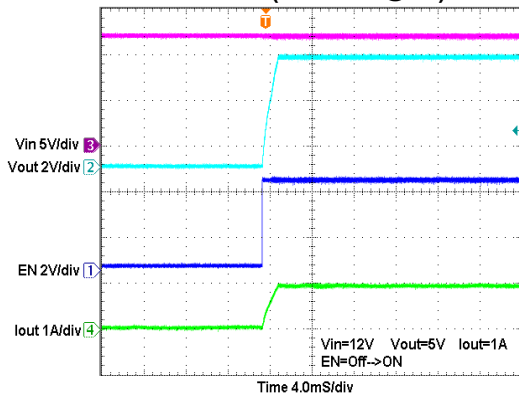

EN Off→ON Test (24V→5V @1A)

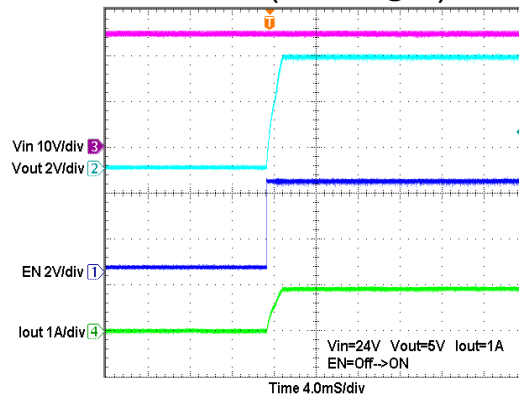



TYPICAL PERFORMANCE CHARACTERISTICS

Load Transient (12V→5V @0.1~1A)

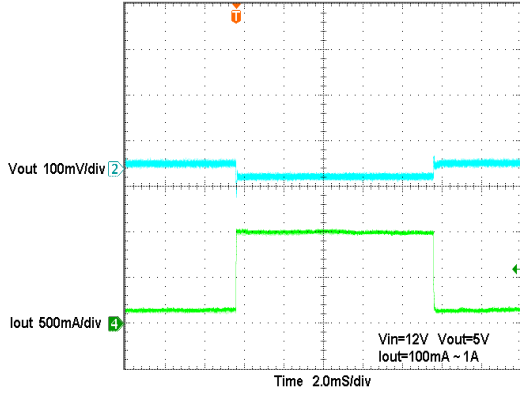

Load Transient (24V→5V @0.1~1A)

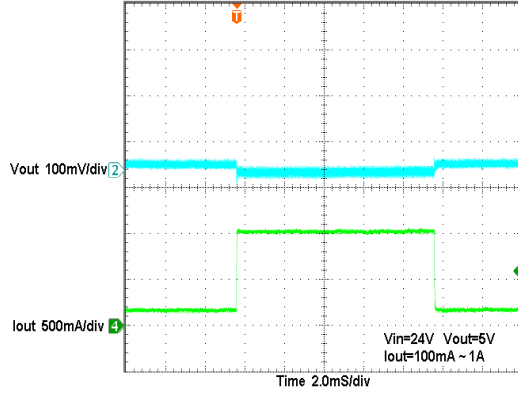



ADVANCED POWER ELECTRONICS CORP.

Package Outline : SOT-23-5L

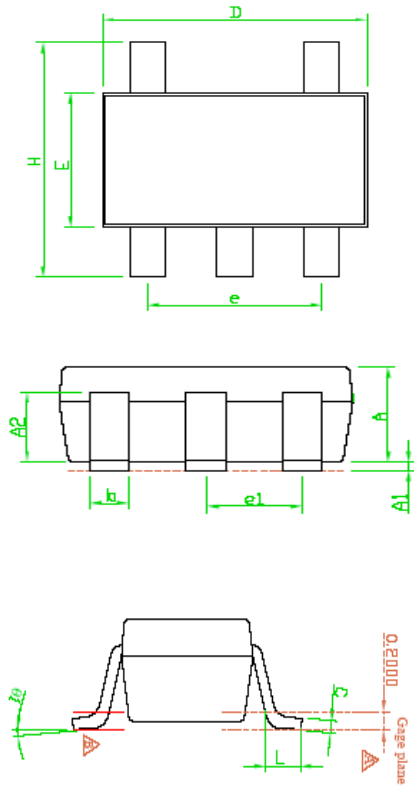

SYMBOLS	Millimeters		
	MIN	NOM	MAX
A	1.00	1.10	1.30
A1	0.00	---	0.10
A2	0.70	0.80	0.90
b	0.30	0.40	0.50
C	0.10	0.15	0.25
D	2.70	2.90	3.10
E	1.40	1.60	1.80
e	---	1.90(TYP)	---
H	2.60	2.80	3.00
L	0.37	---	---
$\theta 1$	0°	5°	9°
e1	---	0.95(TYP)	---

- Note 1 : Package Body Sizes Exclude Mold Flash Protrusions or Gate Burrs.
- Note 2 : Tolerance ± 0.1000 mm(4mil) Unless Otherwise Specified.
- Note 3 : Coplanarity : 0.1000 mm
- Note 4 : Dimension L Is Measured in Gage plane.

Part Marking Information & Packing : SOT-23-5L

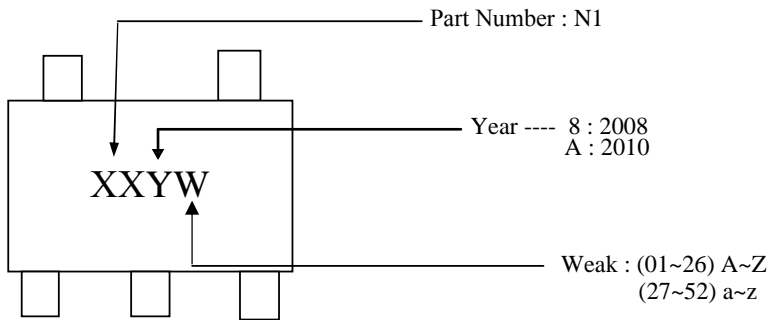



Package Outline : SO-8

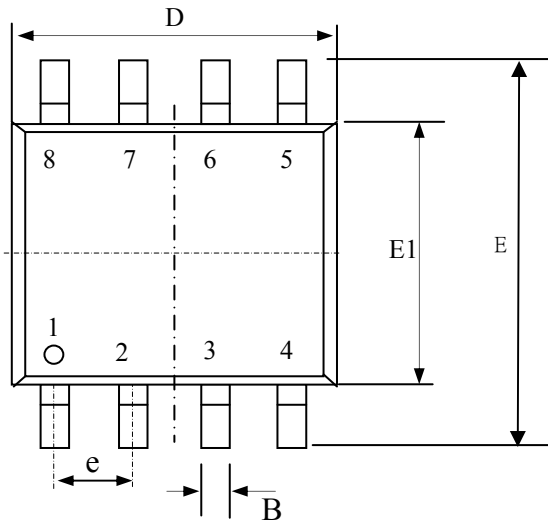

SYMBOLS	Millimeters		
	MIN	NOM	MAX
A	1.35	1.55	1.75
A1	0.10	0.18	0.25
B	0.33	0.41	0.51
c	0.19	0.22	0.25
D	4.80	4.90	5.00
E	5.80	6.15	6.50
E1	3.80	3.90	4.00
e	1.27 TYP		
G	0.254 TYP		
L	0.38	—	0.90
α	0.00	4.00	8.00

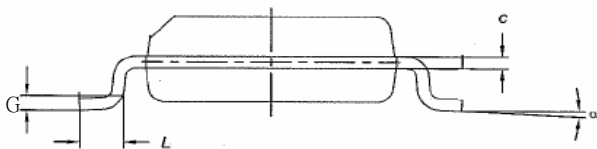
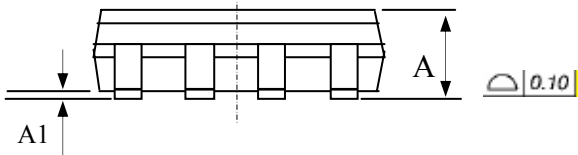

1. All Dimension Are In Millimeters.
2. Dimension Does Not Include Mold Protrusions.

Part Marking Information & Packing : SO-8

