

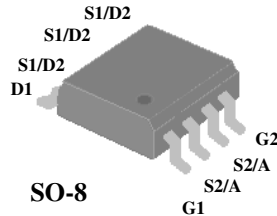

- ▼ Simple Drive Requirement
- ▼ DC-DC Converter Suitable
- ▼ Fast Switching Performance



CH-1	BV_{DSS}	30V
	$R_{DS(ON)}$	22m Ω
	I_D	6.7A
CH-2	BV_{DSS}	30V
	$R_{DS(ON)}$	13m Ω
	I_D	11.5A

Description

The Advanced Power MOSFETs from APEC provide the designer with the best combination of fast switching, ruggedized device design, low on-resistance and cost-effectiveness.

The SO-8 package is universally preferred for all commercial-industrial surface mount applications and suited for low voltage applications such as DC/DC converters.

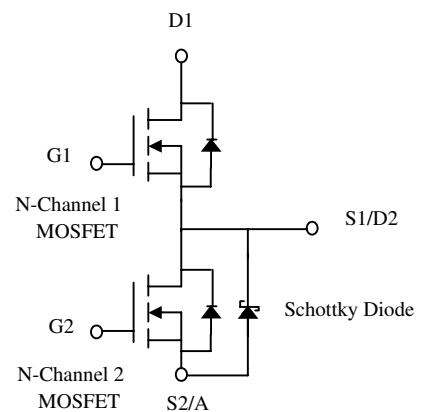

Absolute Maximum Ratings

Symbol	Parameter	Rating		Units
		Channel-1	Channel-2	
V_{DS}	Drain-Source Voltage	30	30	V
V_{GS}	Gate-Source Voltage	± 20	± 20	V
$I_D@T_A=25^\circ C$	Continuous Drain Current ³	6.7	11.5	A
$I_D@T_A=70^\circ C$	Continuous Drain Current ³	5.3	9.2	A
I_{DM}	Pulsed Drain Current ¹	30	40	A
$P_D@T_A=25^\circ C$	Total Power Dissipation	1.4	2.4	W
	Linear Derating Factor	0.01	0.02	W/ $^\circ C$
T_{STG}	Storage Temperature Range	-55 to 150		$^\circ C$
T_J	Operating Junction Temperature Range	-55 to 150		$^\circ C$

Thermal Data

Symbol	Parameter	Value		Units
		Typ.	Max.	
Rthj-a (CH-1)	Thermal Resistance Junction-ambient ³	70	90	$^\circ C/W$
Rthj-a (CH-2)	Thermal Resistance Junction-ambient ³	42	53	$^\circ C/W$
Rthj-a (Schottky)	Thermal Resistance Junction-ambient ³	52	60	$^\circ C/W$



CH-1 Electrical Characteristics@T_j=25°C(unless otherwise specified)

Symbol	Parameter	Test Conditions	Min.	Typ.	Max.	Units
BV _{DSS}	Drain-Source Breakdown Voltage	V _{GS} =0V, I _D =250uA	30	-	-	V
ΔBV _{DSS} /ΔT _j	Breakdown Voltage Temperature Coefficient	Reference to 25°C, I _D =1mA	-	0.03	-	V/°C
R _{DS(ON)}	Static Drain-Source On-Resistance ²	V _{GS} =10V, I _D =6A	-	-	22	mΩ
		V _{GS} =4.5V, I _D =5A	-	-	30	mΩ
V _{GS(th)}	Gate Threshold Voltage	V _{DS} =V _{GS} , I _D =250uA	1	-	3	V
g _{fs}	Forward Transconductance	V _{DS} =10V, I _D =6A	-	10	-	S
I _{DSS}	Drain-Source Leakage Current (T _j =25°C)	V _{DS} =30V, V _{GS} =0V	-	-	1	uA
	Drain-Source Leakage Current (T _j =70°C)	V _{DS} =24V, V _{GS} =0V	-	-	25	uA
I _{GSS}	Gate-Source Leakage	V _{GS} =±20V	-	-	±100	nA
Q _g	Total Gate Charge ²	I _D =6A V _{DS} =24V V _{GS} =4.5V	-	11	18	nC
Q _{gs}	Gate-Source Charge		-	3	-	nC
Q _{gd}	Gate-Drain ("Miller") Charge		-	7	-	nC
t _{d(on)}	Turn-on Delay Time ²	V _{DS} =15V I _D =1A	-	9	-	ns
t _r	Rise Time		-	7	-	ns
t _{d(off)}	Turn-off Delay Time	R _G =3.3Ω, V _{GS} =10V R _D =15Ω	-	22	-	ns
t _f	Fall Time		-	7	-	ns
C _{iss}	Input Capacitance	V _{GS} =0V V _{DS} =25V f=1.0MHz	-	780	1250	pF
C _{oss}	Output Capacitance		-	180	-	pF
C _{rss}	Reverse Transfer Capacitance		-	140	-	pF
R _g	Gate Resistance	f=1.0MHz	-	1.25	-	Ω

Source-Drain Diode

Symbol	Parameter	Test Conditions	Min.	Typ.	Max.	Units
V _{SD}	Forward On Voltage ²	I _S =1.2A, V _{GS} =0V	-	-	1.2	V
t _{rr}	Reverse Recovery Time ²	I _S =6A, V _{GS} =0V dI/dt=100A/μs	-	21	-	ns
Q _{rr}	Reverse Recovery Charge		-	15	-	nC



CH-2 Electrical Characteristics@T_j=25°C(unless otherwise specified)

Symbol	Parameter	Test Conditions	Min.	Typ.	Max.	Units
BV _{DSS}	Drain-Source Breakdown Voltage	V _{GS} =0V, I _D =250uA	30	-	-	V
ΔBV _{DSS} /ΔT _j	Breakdown Voltage Temperature Coefficient	Reference to 25°C, I _D =1mA	-	0.03	-	V/°C
R _{DS(ON)}	Static Drain-Source On-Resistance ²	V _{GS} =10V, I _D =11A	-	-	13	mΩ
		V _{GS} =4.5V, I _D =8A	-	-	18.5	mΩ
V _{GS(th)}	Gate Threshold Voltage	V _{DS} =V _{GS} , I _D =250uA	1	-	3	V
g _{fs}	Forward Transconductance	V _{DS} =10V, I _D =11A	-	15	-	S
I _{DSS}	Drain-Source Leakage Current (T _j =25°C)	V _{DS} =30V, V _{GS} =0V	-	-	100	uA
	Drain-Source Leakage Current (T _j =70°C)	V _{DS} =24V, V _{GS} =0V	-	-	1	mA
I _{GSS}	Gate-Source Leakage	V _{GS} =±20V	-	-	±100	nA
Q _g	Total Gate Charge ²	I _D =8A	-	20	30	nC
Q _{gs}	Gate-Source Charge	V _{DS} =24V	-	5	-	nC
Q _{gd}	Gate-Drain ("Miller") Charge	V _{GS} =4.5V	-	12	-	nC
t _{d(on)}	Turn-on Delay Time ²	V _{DS} =15V	-	12	-	ns
t _r	Rise Time	I _D =1A	-	8	-	ns
t _{d(off)}	Turn-off Delay Time	R _G =3.3Ω, V _{GS} =10V	-	31	-	ns
t _f	Fall Time	R _D =15Ω	-	12	-	ns
C _{iss}	Input Capacitance	V _{GS} =0V	-	1450	2320	pF
C _{oss}	Output Capacitance	V _{DS} =25V	-	320	-	pF
C _{rss}	Reverse Transfer Capacitance	f=1.0MHz	-	230	-	pF
R _g	Gate Resistance	f=1.0MHz	-	1.5	-	Ω

Source-Drain Diode

Symbol	Parameter	Test Conditions	Min.	Typ.	Max.	Units
V _{SD}	Forward On Voltage ²	I _S =1A, V _{GS} =0V	-	-	0.5	V
t _{rr}	Reverse Recovery Time ²	I _S =8A, V _{GS} =0V	-	27	-	ns
Q _{rr}	Reverse Recovery Charge	di/dt=100A/μs	-	18	-	nC

Notes:

- 1.Pulse width limited by Max. junction temperature.
- 2.Pulse test
- 3.Surface mounted on 1 in² copper pad of FR4 board, t ≤10 sec.

THIS PRODUCT IS AN ELECTROSTATIC SENSITIVE, PLEASE HANDLE WITH CAUTION.

THIS PRODUCT HAS BEEN QUALIFIED FOR CONSUMER MARKET. APPLICATIONS OR USES AS CRITERIAL COMPONENT IN LIFE SUPPORT DEVICE OR SYSTEM ARE NOT AUTHORIZED.



AP4816GSM

Schottky Specifications@ $T_j=25^{\circ}\text{C}$ (unless otherwise specified)

Symbol	Parameter	Test Conditions	Min.	Typ.	Max.	Units
V_F	Forward Voltage Drop	$I_F=1.0\text{A}$	-	0.47	0.5	V
I_{rm}	Maximum Reverse Leakage Current	$V_r=30\text{V}$	-	0.004	0.2	mA
	Maximum Reverse Leakage Current	$V_r=30\text{V}, T_j=100^{\circ}\text{C}$	-	0.5	1	mA
C_T	Junction Capacitance	$V_r=10\text{V}$	-	66	-	pF



Channel-1

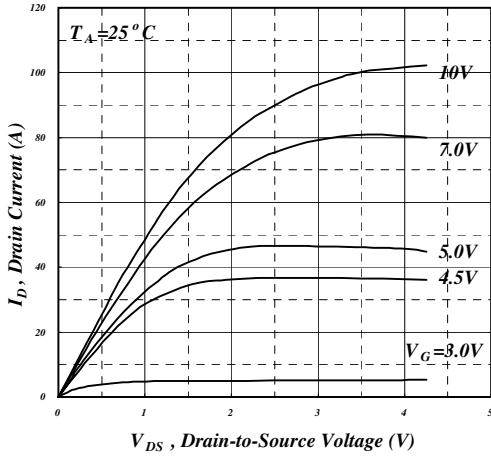

Fig 1. Typical Output Characteristics

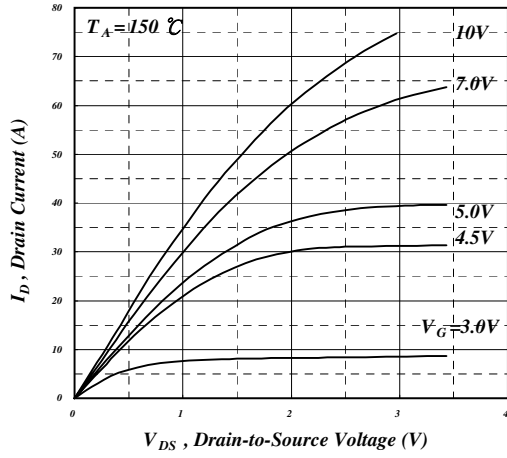

Fig 2. Typical Output Characteristics

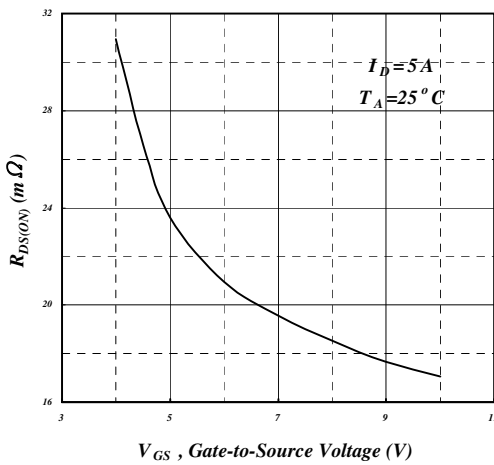

Fig 3. On-Resistance v.s. Gate Voltage

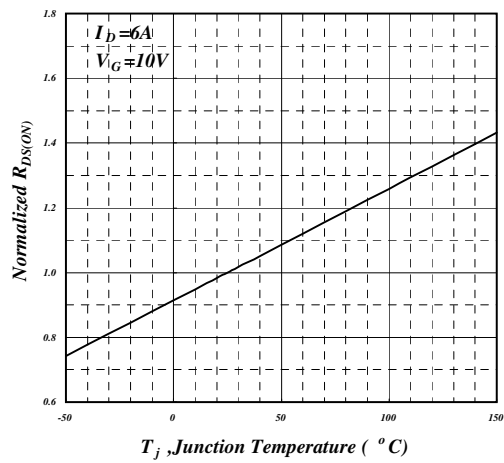

Fig 4. Normalized On-Resistance v.s. Junction Temperature

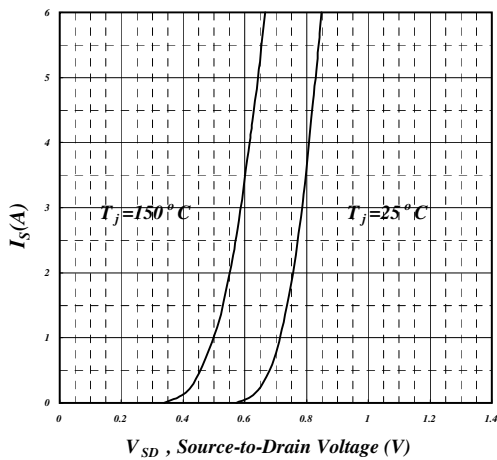

Fig 5. Forward Characteristic of Reverse Diode

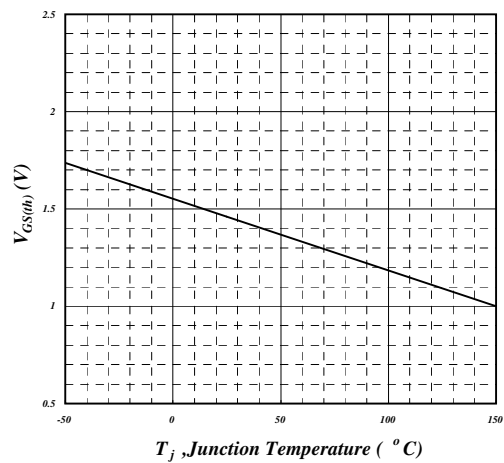

Fig 6. Gate Threshold Voltage v.s. Junction Temperature



AP4816GSM

Channel-1

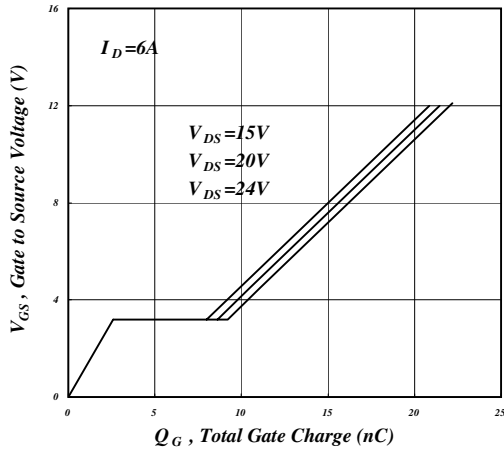

Fig 7. Gate Charge Characteristics

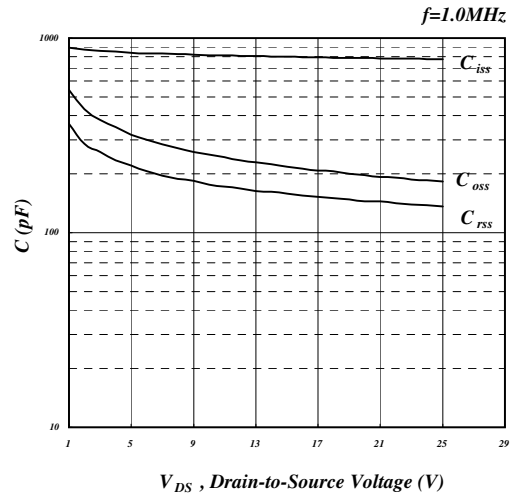

Fig 8. Typical Capacitance Characteristics

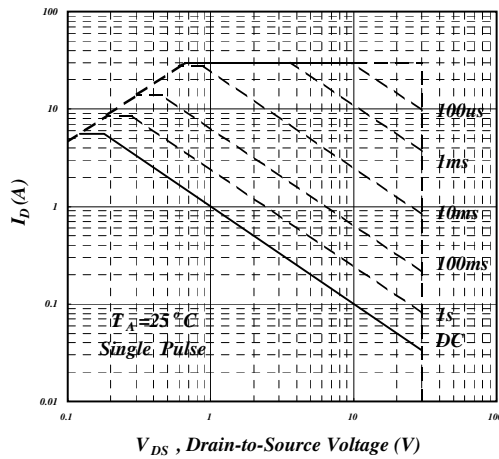

Fig 9. Maximum Safe Operating Area

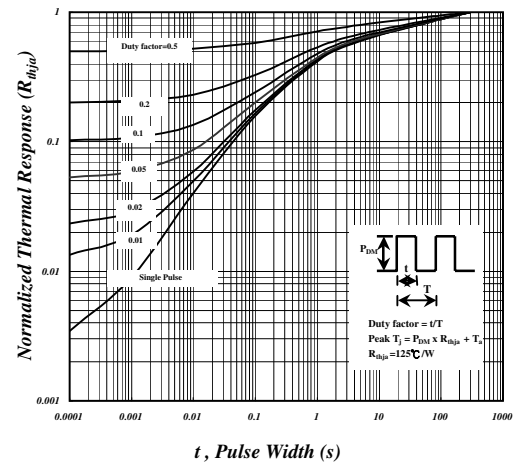

Fig 10. Effective Transient Thermal Impedance

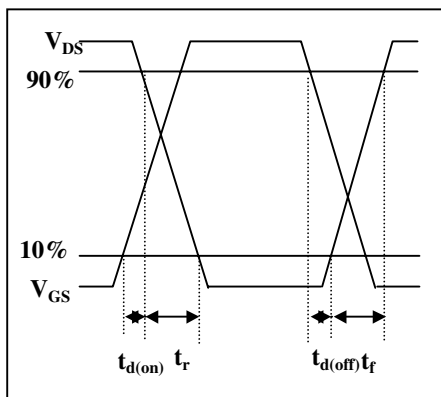

Fig 11. Switching Time Waveform

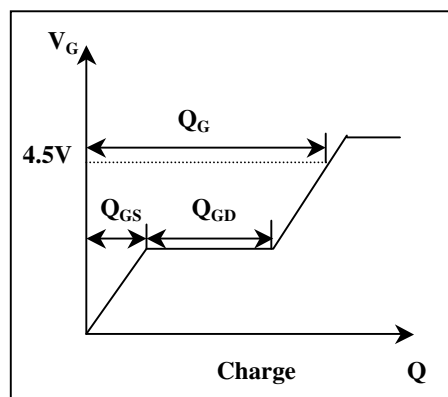

Fig 12. Gate Charge Waveform



Channel-2

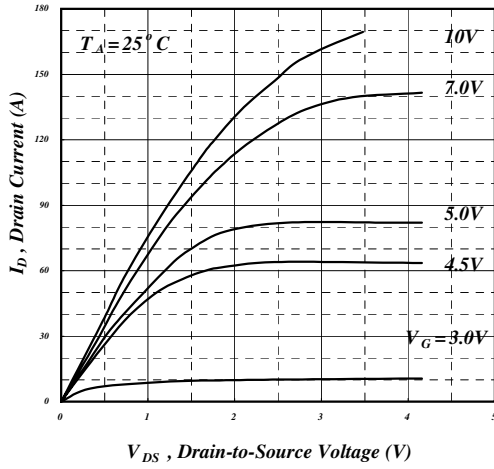

Fig 1. Typical Output Characteristics

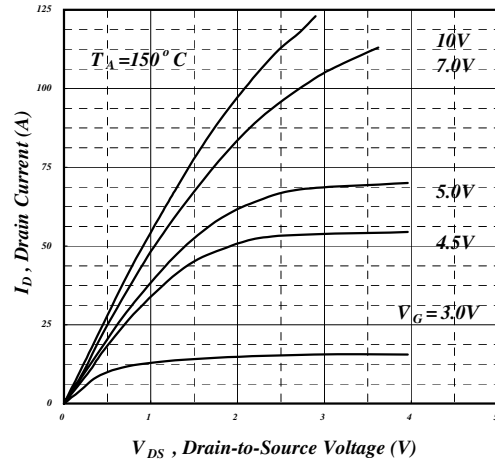

Fig 2. Typical Output Characteristics

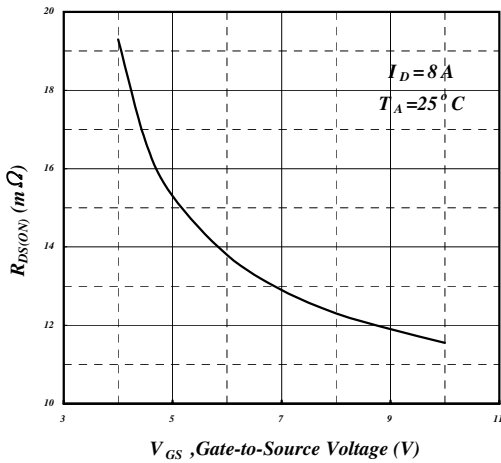

Fig 3. On-Resistance v.s. Gate Voltage

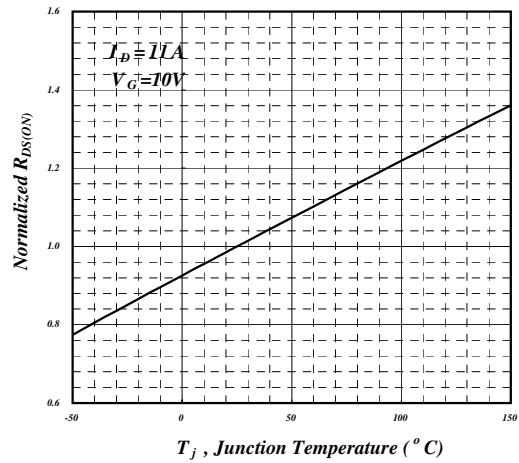

Fig 4. Normalized On-Resistance v.s. Junction Temperature

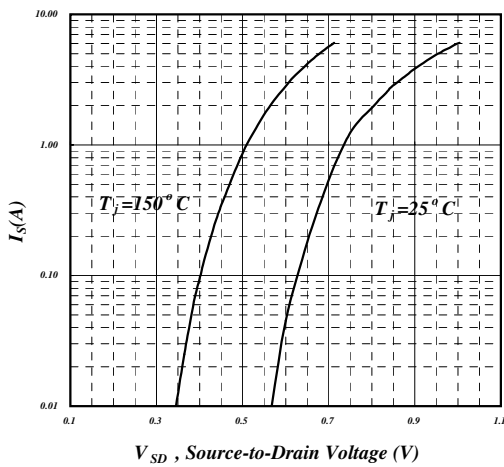

Fig 5. Forward Characteristic of Reverse Diode

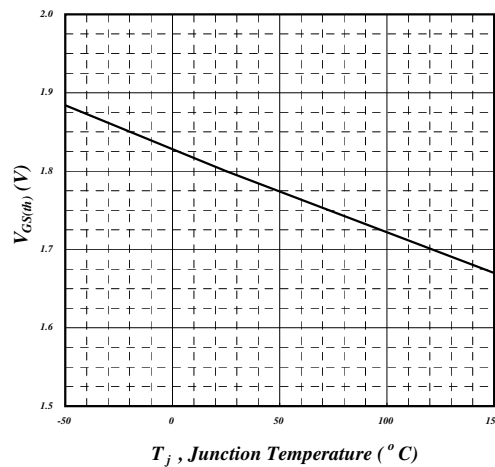

Fig 6. Gate Threshold Voltage v.s. Junction Temperature



AP4816GSM

Channel-2

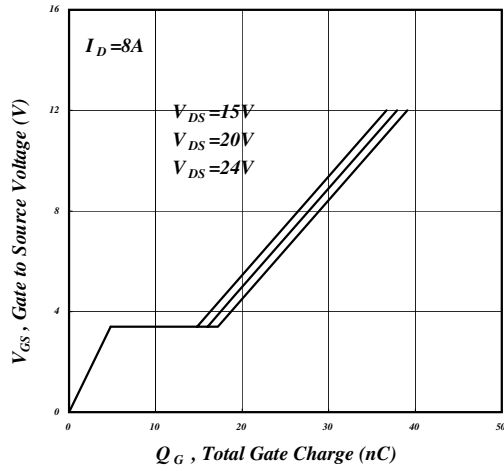

Fig 7. Gate Charge Characteristics

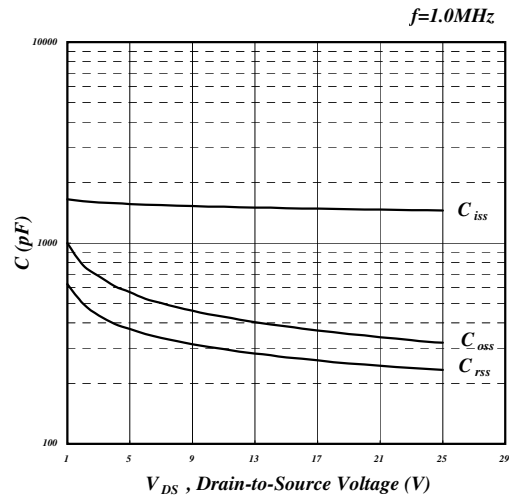

Fig 8. Typical Capacitance Characteristics

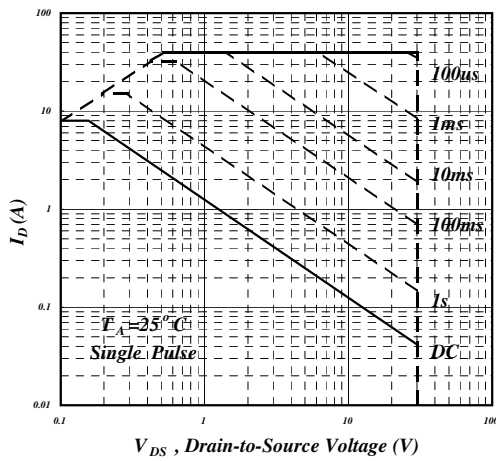

Fig 9. Maximum Safe Operating Area

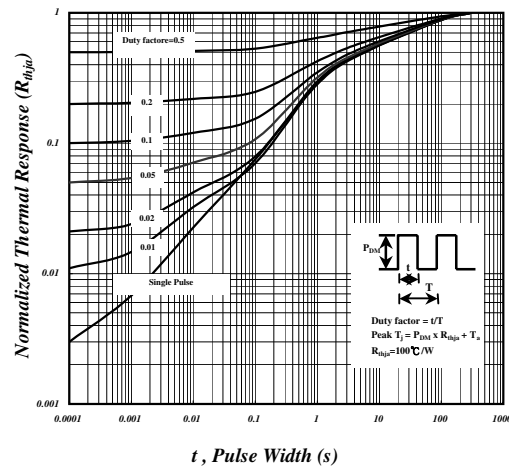

Fig 10. Effective Transient Thermal Impedance

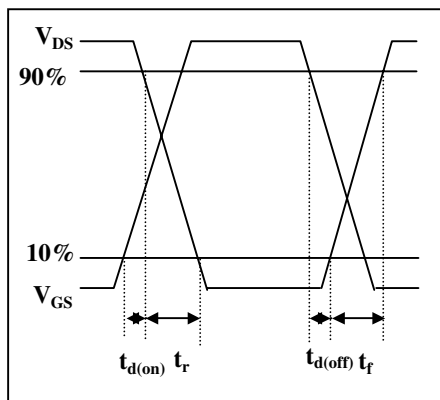

Fig 11. Switching Time Waveform

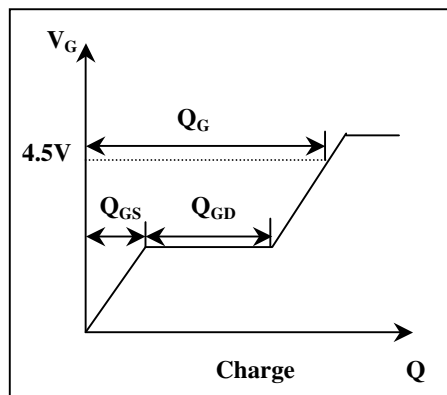

Fig 12. Gate Charge Waveform



Schottky

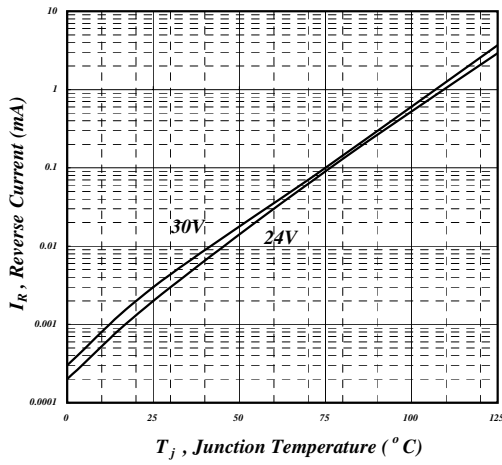

Fig 1. Reverse Current vs Junction Temperature

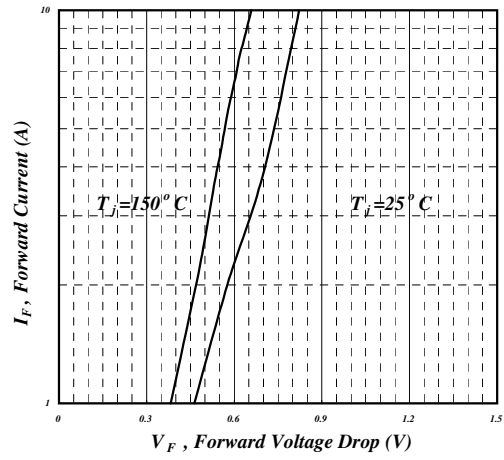

Fig 2. Typical Forward Characteristics

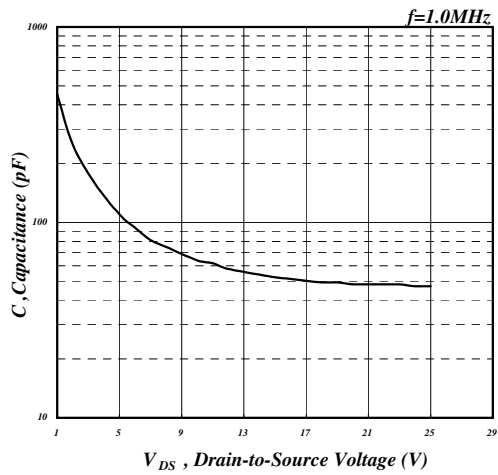

Fig 3. Typical Junction Capacitance