

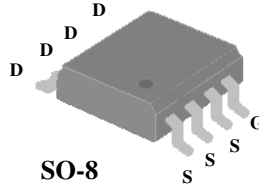

- ▼ Low On Resistance
- ▼ Capable of 2.5V Drive
- ▼ Fast Switching
- ▼ RoHS Compliant



| | |
|--------------|--------------|
| BV_{DSS} | -20V |
| $R_{DS(ON)}$ | 20m Ω |
| I_D | -9.5A |

Description

Advanced Power MOSFETs from APEC provide the designer with the best combination of fast switching, ruggedized device design, low on-resistance and cost-effectiveness.

The SO-8 package is widely preferred for all commercial-industrial surface mount applications and suited for low voltage applications such as DC/DC converters.

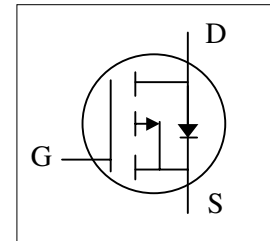

Absolute Maximum Ratings

| Symbol | Parameter | Rating | Units |
|----------------------------|---------------------------------------|------------|---------------------|
| V_{DS} | Drain-Source Voltage | -20 | V |
| V_{GS} | Gate-Source Voltage | ± 8 | V |
| $I_D@T_A=25^\circ\text{C}$ | Continuous Drain Current ³ | -9.5 | A |
| $I_D@T_A=70^\circ\text{C}$ | Continuous Drain Current ³ | -7.6 | A |
| I_{DM} | Pulsed Drain Current ¹ | -76 | A |
| $P_D@T_A=25^\circ\text{C}$ | Total Power Dissipation | 2.5 | W |
| | Linear Derating Factor | 0.02 | W/ $^\circ\text{C}$ |
| T_{STG} | Storage Temperature Range | -55 to 150 | $^\circ\text{C}$ |
| T_J | Operating Junction Temperature Range | -55 to 150 | $^\circ\text{C}$ |

Thermal Data

| Symbol | Parameter | Value | Unit |
|---------------|---|-------|---------------------------|
| $R_{thj-amb}$ | Maximum Thermal Resistance, Junction-ambient ³ | 50 | $^\circ\text{C}/\text{W}$ |



AP9620GM-HF

Electrical Characteristics@T_j=25°C(unless otherwise specified)

| Symbol | Parameter | Test Conditions | Min. | Typ. | Max. | Units |
|---------------------|---|---|------|------|------|-------|
| BV _{DSS} | Drain-Source Breakdown Voltage | V _{GS} =0V, I _D =-250uA | -20 | - | - | V |
| R _{DS(ON)} | Static Drain-Source On-Resistance ² | V _{GS} =-4.5V, I _D =-9.5A | - | - | 20 | mΩ |
| | | V _{GS} =-2.5V, I _D =-6.0A | - | - | 35 | mΩ |
| V _{GS(th)} | Gate Threshold Voltage | V _{DS} =V _{GS} , I _D =-250uA | - | - | -1 | V |
| g _{fs} | Forward Transconductance | V _{DS} =-10V, I _D =-9.5A | - | 28 | - | S |
| I _{DSS} | Drain-Source Leakage Current | V _{DS} =-20V, V _{GS} =0V | - | - | -1 | uA |
| | Drain-Source Leakage Current (T _j =70°C) | V _{DS} =-16V, V _{GS} =0V | - | - | -25 | uA |
| I _{GSS} | Gate-Source Leakage | V _{GS} = ± 8V | - | - | ±100 | nA |
| Q _g | Total Gate Charge ² | I _D =-9.5A | - | 30 | - | nC |
| Q _{gs} | Gate-Source Charge | V _{DS} =-10V | - | 6 | - | nC |
| Q _{gd} | Gate-Drain ("Miller") Charge | V _{GS} =-5V | - | 3.5 | - | nC |
| t _{d(on)} | Turn-on Delay Time ² | V _{DS} =-10V | - | 26 | - | ns |
| t _r | Rise Time | I _D =-9.5A | - | 500 | - | ns |
| t _{d(off)} | Turn-off Delay Time | R _G =6Ω, V _{GS} =-4.5V | - | 70 | - | ns |
| t _f | Fall Time | R _D =1.05Ω | - | 300 | - | ns |
| C _{ISS} | Input Capacitance | V _{GS} =0V | - | 2158 | - | pF |
| C _{OSS} | Output Capacitance | V _{DS} =-15V | - | 845 | - | pF |
| C _{rSS} | Reverse Transfer Capacitance | f=1.0MHz | - | 230 | - | pF |

Source-Drain Diode

| Symbol | Parameter | Test Conditions | Min. | Typ. | Max. | Units |
|-----------------|--|--|------|------|-------|-------|
| I _S | Continuous Source Current (Body Diode) | V _D =V _G =0V , V _S =-1.2V | - | - | -2.08 | A |
| V _{SD} | Forward On Voltage ² | T _j =25°C, I _S =-2.5A, V _{GS} =0V | - | - | -1.2 | V |

Notes:

- 1.Pulse width limited by Max. junction temperature.
- 2.Pulse test
- 3.Surface mounted on 1 in² copper pad of FR4 board ; 125 °C/W when mounted on Min. copper pad.

THIS PRODUCT IS SENSITIVE TO ELECTROSTATIC DISCHARGE, PLEASE HANDLE WITH CAUTION.

USE OF THIS PRODUCT AS A CRITICAL COMPONENT IN LIFE SUPPORT OR OTHER SIMILAR SYSTEMS IS NOT AUTHORIZED.

APEC DOES NOT ASSUME ANY LIABILITY ARISING OUT OF THE APPLICATION OR USE OF ANY PRODUCT OR CIRCUIT DESCRIBED HEREIN; NEITHER DOES IT CONVEY ANY LICENSE UNDER ITS PATENT RIGHTS, NOR THE RIGHTS OF OTHERS.

APEC RESERVES THE RIGHT TO MAKE CHANGES WITHOUT FURTHER NOTICE TO ANY PRODUCTS HEREIN TO IMPROVE RELIABILITY, FUNCTION OR DESIGN.

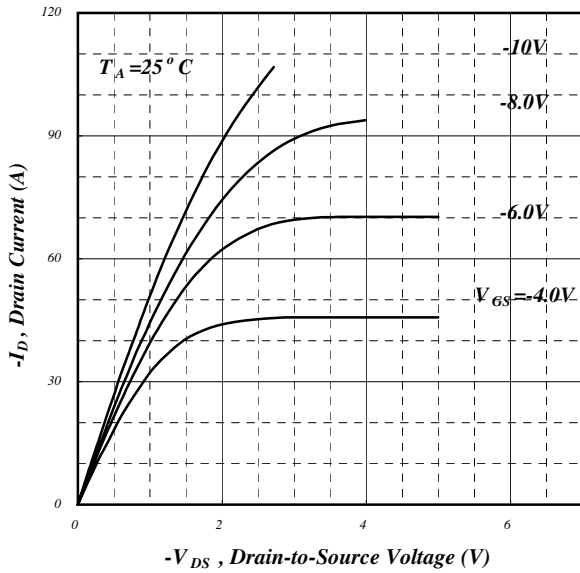

Fig 1. Typical Output Characteristics

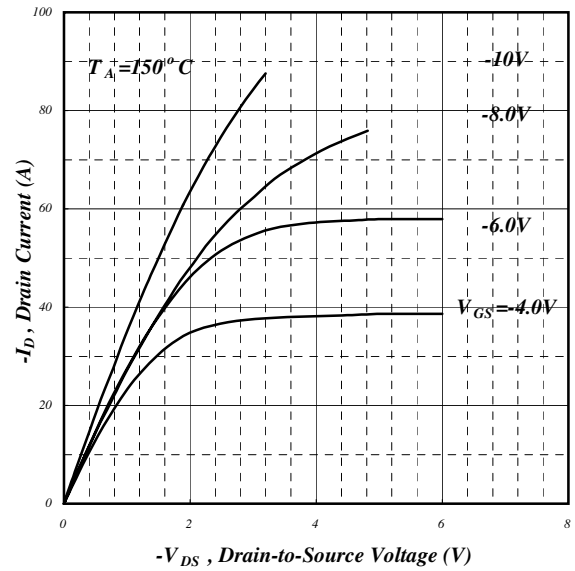

Fig 2. Typical Output Characteristics

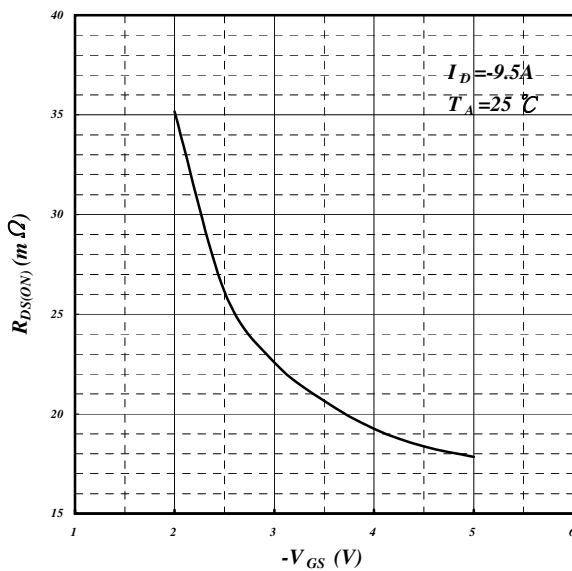

Fig 3. On-Resistance v.s. Gate Voltage

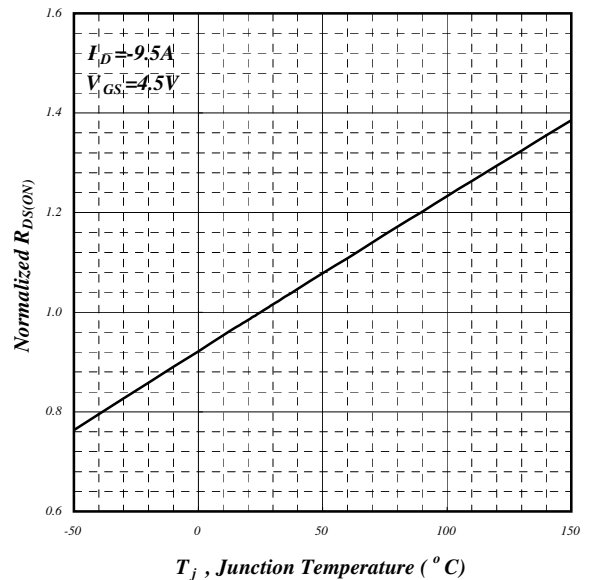

Fig 4. Normalized On-Resistance v.s. Junction Temperature

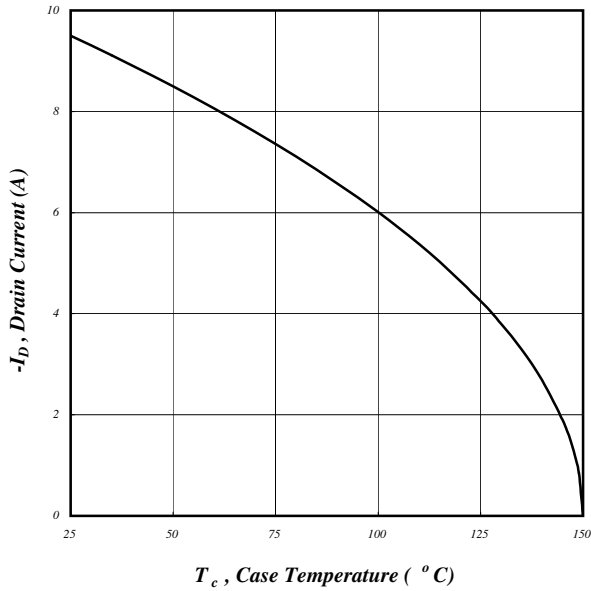

Fig 5. Maximum Drain Current v.s. Case Temperature

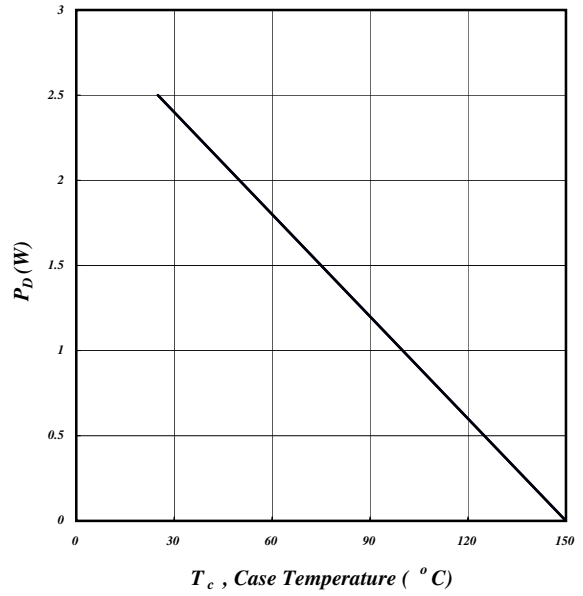

Fig 6. Typical Power Dissipation

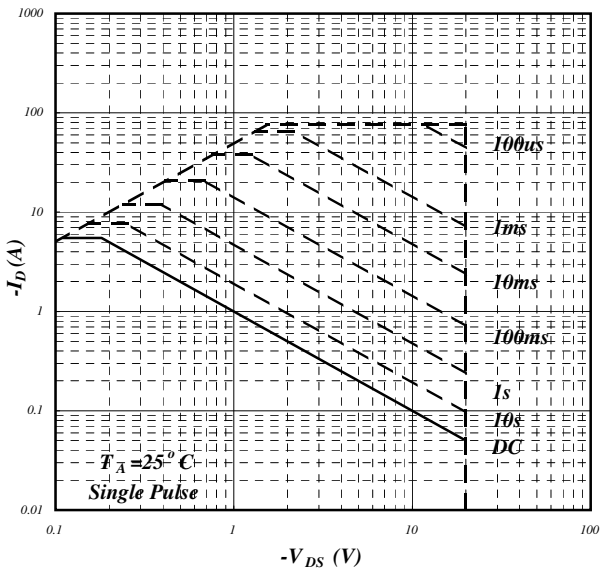

Fig 7. Maximum Safe Operating Area

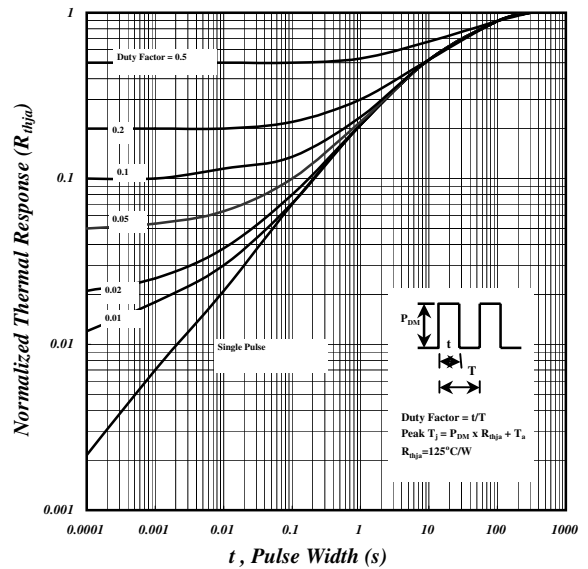

Fig 8. Effective Transient Thermal Impedance

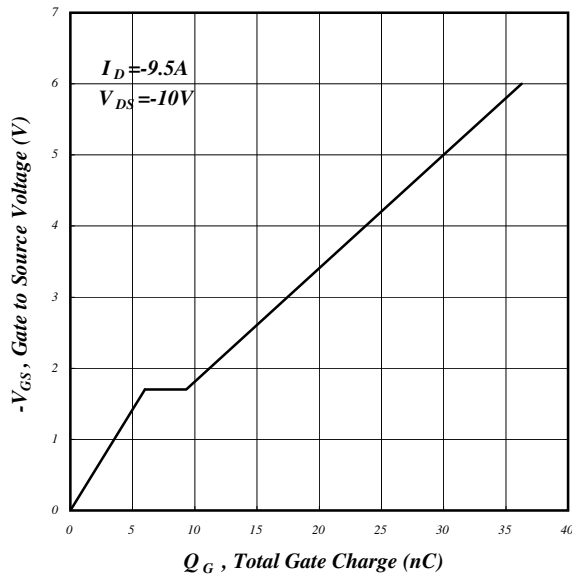

Fig 9. Gate Charge Characteristics

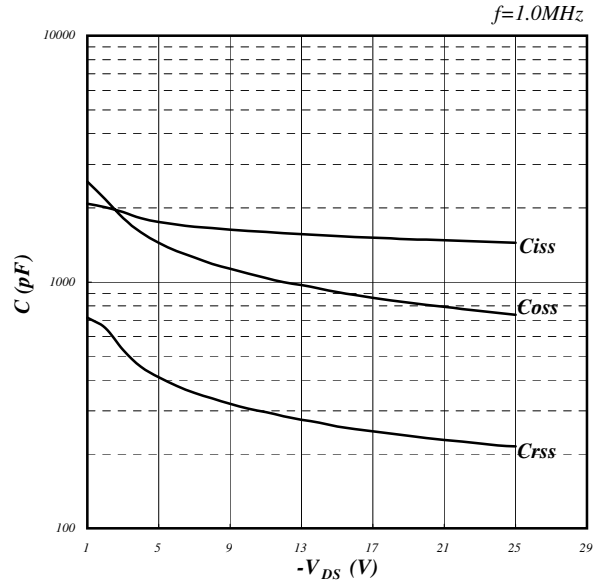

Fig 10. Typical Capacitance Characteristics

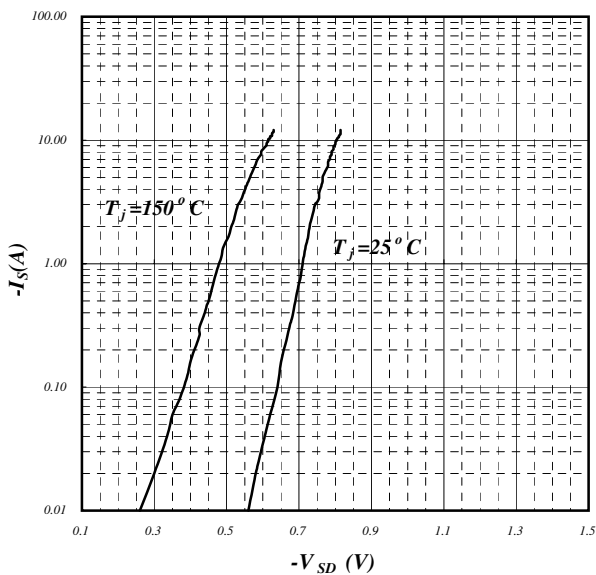

Fig 11. Forward Characteristic of Reverse Diode

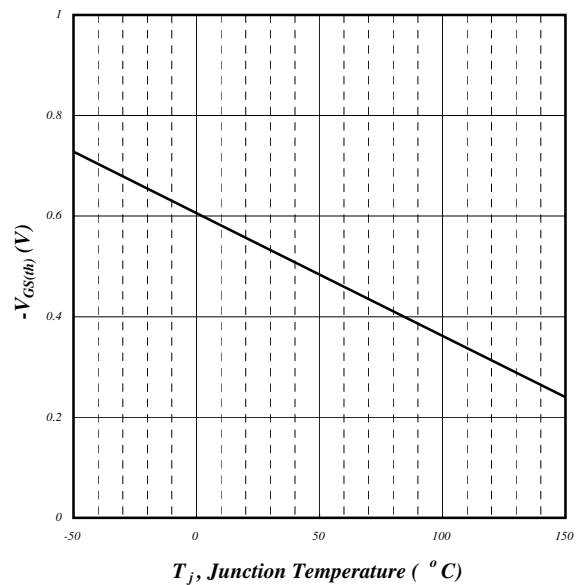

Fig 12. Gate Threshold Voltage v.s. Junction Temperature

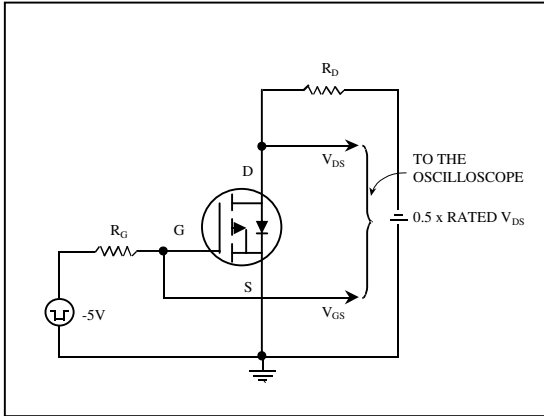

Fig 13. Switching Time Circuit

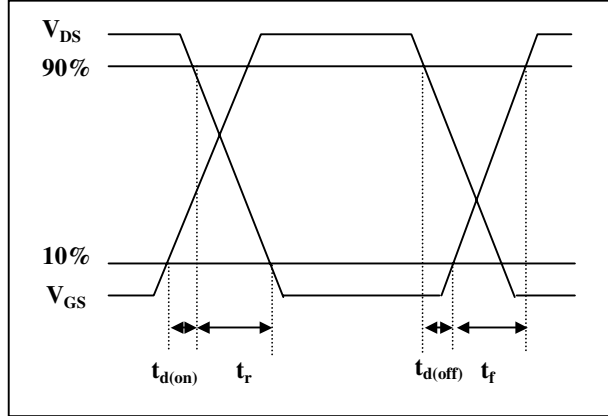

Fig 14. Switching Time Waveform

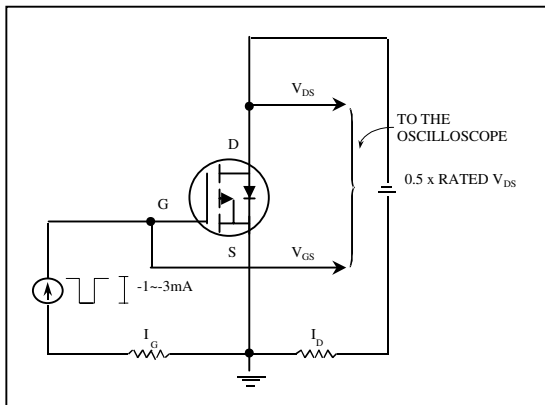

Fig 15. Gate Charge Circuit

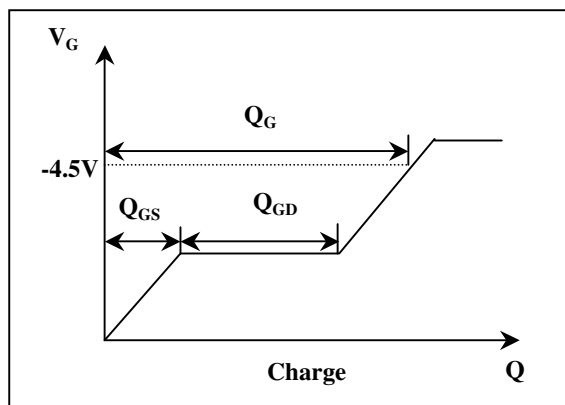
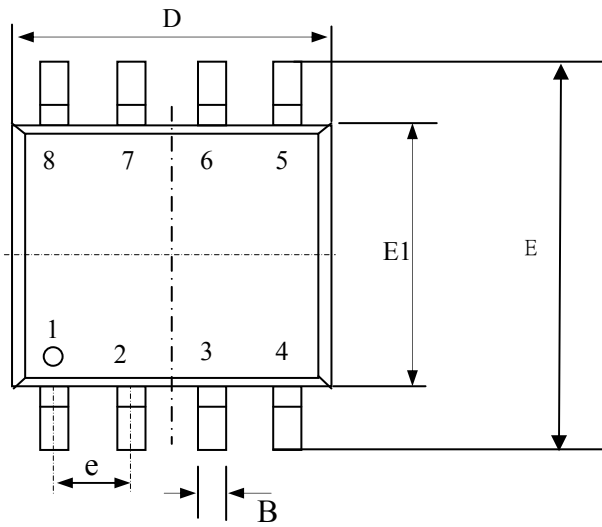

Fig 16. Gate Charge Waveform



Package Outline : SO-8



| SYMBOLS | Millimeters | | |
|----------|-------------|------|------|
| | MIN | NOM | MAX |
| A | 1.35 | 1.55 | 1.75 |
| A1 | 0.10 | 0.18 | 0.25 |
| B | 0.33 | 0.41 | 0.51 |
| c | 0.19 | 0.22 | 0.25 |
| D | 4.80 | 4.90 | 5.00 |
| E1 | 3.80 | 3.90 | 4.00 |
| E | 5.80 | 6.15 | 6.50 |
| L | 0.38 | 0.71 | 1.27 |
| θ | 0.00 | 4.00 | 8.00 |
| e | 1.27 TYP | | |

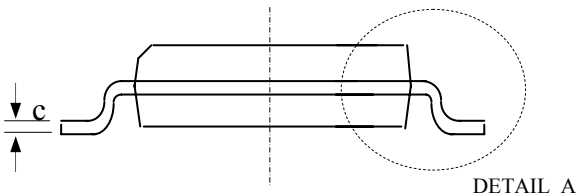
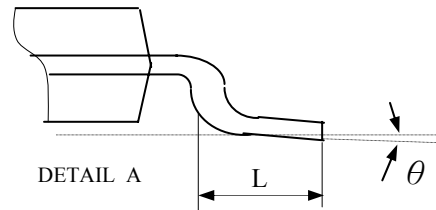
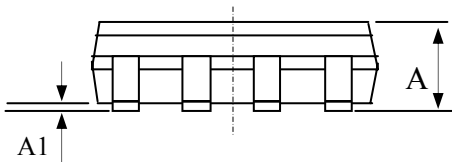

1. All Dimension Are In Millimeters.
2. Dimension Does Not Include Mold Protrusions.

Part Marking Information & Packing : SO-8

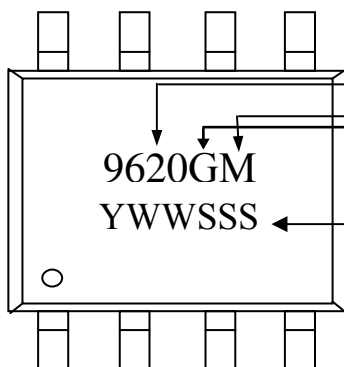

Part Number Package Code

meet Rohs requirement
for low voltage MOSFET only

Date Code (ywwsss)

Y : Last Digit Of The Year

WW : Week

SSS : Sequence

If last "S" is numerical letter : Rohs product

If last "S" is English letter : HF & Rohs