



FEATURES

- 1.5V Maximum Dropout at Full Load Current
- Built-in Thermal Shutdown for Each Channel
- Output Current Limiting for Each Channel
- Fast Transient Response
- Good Noise Rejection
- Dual Output
- VOUT1 : 3.3V / 500mA
- VOUT2 : 1.8V / 500mA (depend on bottom Exposed Pad Size & VIN Voltage)
- SOP-8 with Exposed Pad
- Need only 1uF MLCC for Stability

DESCRIPTION

APE8839 is dual low dropout positive regulator with minimum of 500mA output current capability. The product is specifically designed to provide well-regulated supply for low voltage IC applications such as high-speed bus termination and low current 3.3V/1.8V, logic supply. APE8839 series are guaranteed to have <1.5V dropout at full load current making it ideal to provide well regulated outputs dual channels with up to 12V input supply, but depend on Power Dissipation Limitation for using. To prevent oscillation, it is recommended to use minimum 1uF dielectric capacitors for Input/Output Capacitors, In general, the input capacitor in the range of 1uF to 10uF sufficient.

APPLICATION

- PC peripheral
- Communication

TYPICAL APPLICATION

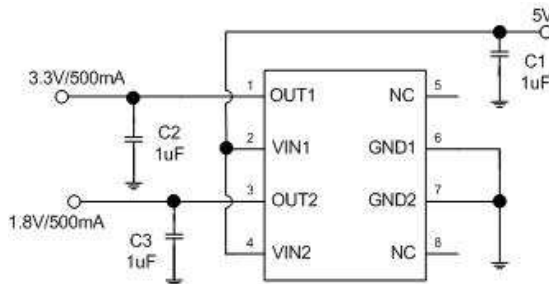

PACKAGE ORDERING INFORMATION

APE8839X
 Package type
 MP : ESOP-8L



ABSOLUTE MAXIMUM RATINGS

DC Supply Voltage (V_{IN})	-0.3 to 12 V
Power Dissipation(P_D)	Internally Limited
Storage Temperature Range(T_{ST})	-65°C To 150°C
Operating Junction Temperature Range(T_{OP})	0°C To + 125°C

PACKAGE INFORMATION

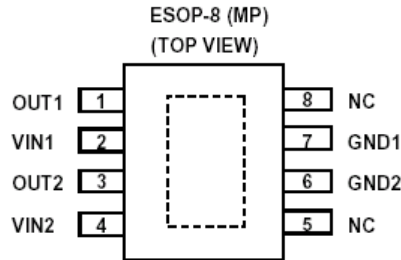

ELECTRICAL SPECIFICATIONS

(Under Operating Conditon)

Parameter	SYM	TEST CONDITION	MIN	TYP	MAX	UNITS
Output Voltage	V_{OUT1}	$I_{OUT}=10mA, T_J=25^\circ C, 4.8V \leq V_{IN} \leq 12V$	3.235	3.3	3.365	V
	V_{OUT2}	$I_{OUT}=10mA, T_J=25^\circ C, 4V \leq V_{IN} \leq 12V$	1.764	1.8	1.836	V
Line Regulation		$I_O=10mA, V_{OUT}+1.5V < V_{IN} < V_{OUT}+6V, T_J=25^\circ C$	-	-	0.3	%
Load Regulation		$T_J=25^\circ C, V_{IN}=V_{OUT}+1.5V, 10mA \leq I_{OUT} \leq 0.5A(\text{Note1,2})$	-	-	1	%
Dropout Voltage($V_{IN}-V_{OUT}$)		$I_{OUT}=0.5A, \Delta V_{OUT}=1\%V_{OUT}$	-	1.2	1.5	V
Current Limit		$V_{IN}-V_{OUT}=5V$	0.8	1.1	-	A
Minimum Load Current		$0^\circ C \leq T_J \leq 125^\circ C(\text{Note3})$	-	5	10	mA
Thermal Regulation		$T_A=25^\circ C, 30ms \text{ pulse}$	-	0.008	0.04	%/W
Ripple Rejection		$F=120Hz, C_{OUT}=25\mu F, \text{ Tantalum}, I_{OUT}=0.5A$	-	60	70	dB
Temperature Stability		$I_O=10mA$	-	0.5	-	%
Thermal Shutdown Temperature			-	150	-	$^\circ C$
Thermal Shutdown Temperature Recovery			-	130	-	$^\circ C$
R_{thja} Thermal Resistance Junction-to-Ambient(Note4)	OUT1 or OUT2 only		-	70	-	$^\circ C/W$
	OUT1 & OUT2 and PD1=PD2		-	52	-	
R_{thjc} Thermal Resistance Junction-to-Case	OUT1 or OUT2 only		-	18	-	
	OUT1 & OUT2 and PD1=PD2		-	7	-	

Note1: See thermal regulation specifications for changes in output voltage due to heating effects.

Line and load regulation are measured at a constant junction temperature by low duty cycle pulse testing.

Load regulation is measured at the output lead = 1/18" from the package.

Note2: Line and load regulation are guaranteed up to the maximum power dissipation of 2W. Power dissipation is determined by the input/output differentially and the output current. Guaranteed maximum power dissipation will not be available over the full input/output range.

Note3: Quiescent current is defined as the minimum output current that requires maintaining regulation. At 12V input/output differential the device is guaranteed to regulate if the output current is greater than 10mA.

Note4: Thermal resistance is measured by mounted on a high effective thermal conductivity test board in free air.

The bottom exposed pad of ESOP-8 is soldered directly on the PCB.



PIN DESCRIPTIONS

PIN SYMBOL	PIN DESCRIPTION
GND1 / GND2	Ground for fix output version
VOUT1 / OUT2	The output of the regulator. A minimum of 1uF capacitor ($10\text{m}\Omega \leq \text{ESR} \leq 1\Omega$) must be connected from this pin to ground to insure stability.
VIN1 / VIN2	The input pin of regulator. Typically a minimum of 1uF capacitor is connected from this pin to ground to insure that the input voltage does not sag below the minimum dropout voltage during the load transient response. The pin must always be 1.5V higher than Vout in order for the device to regulate properly.
Exposed Pad	No function

BLOCK DIAGRAM

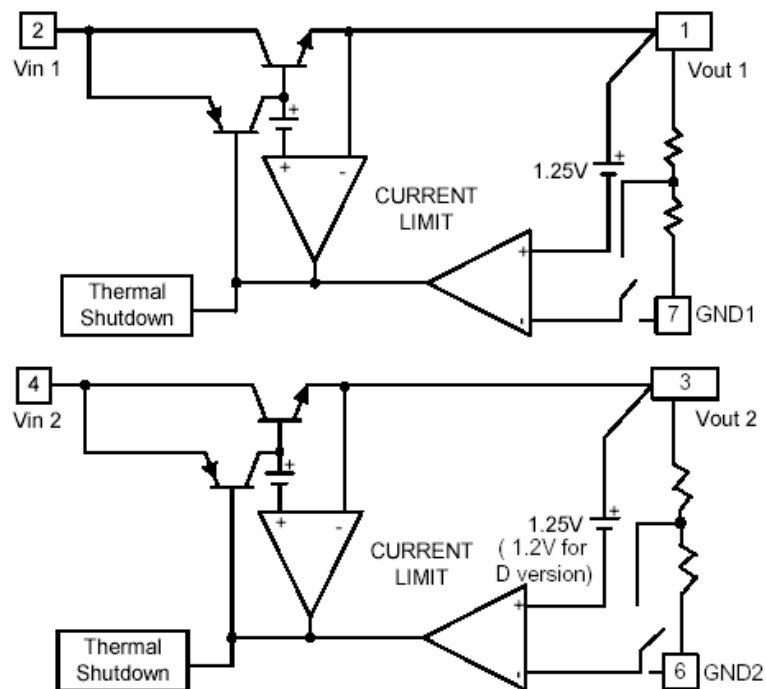



TYPICAL PERFORMANCE CHARACTERISTICS (VOUT1)

Line Regulation

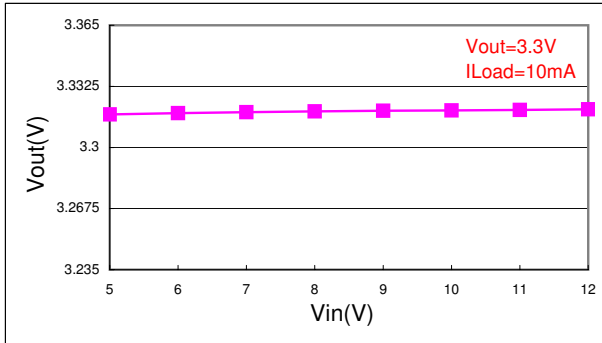

Load Regulation

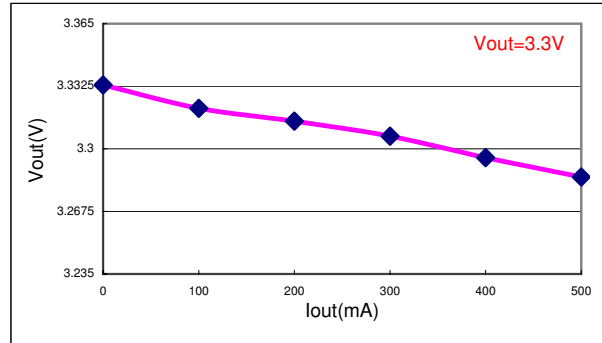

Load Transient



Line Transient

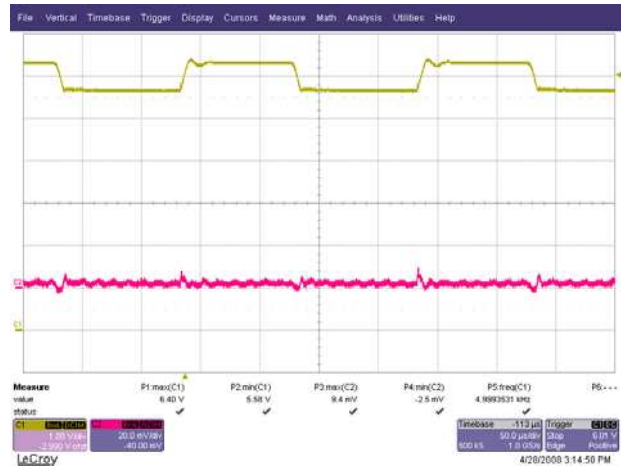

V_o VS I_o

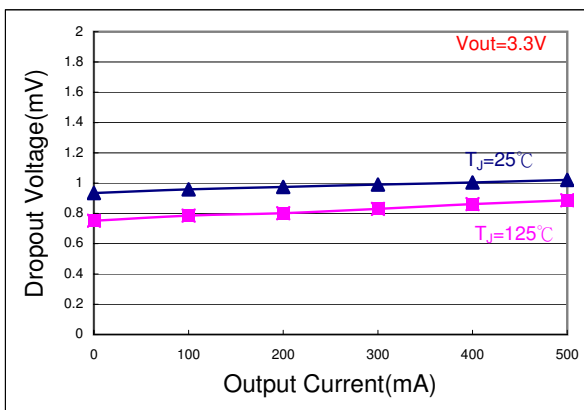

V_o VS TEMP.

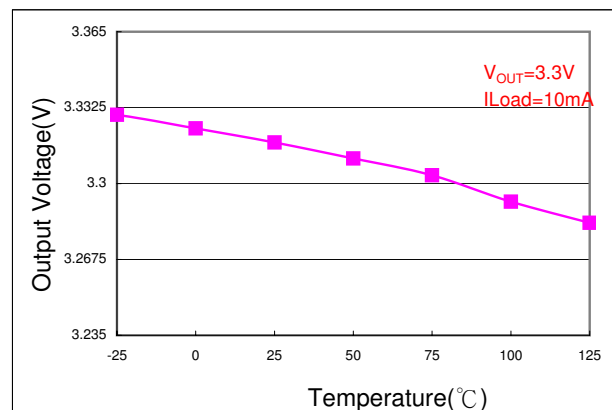



TYPICAL PERFORMANCE CHARACTERISTICS (VOUT2)

Line Regulation

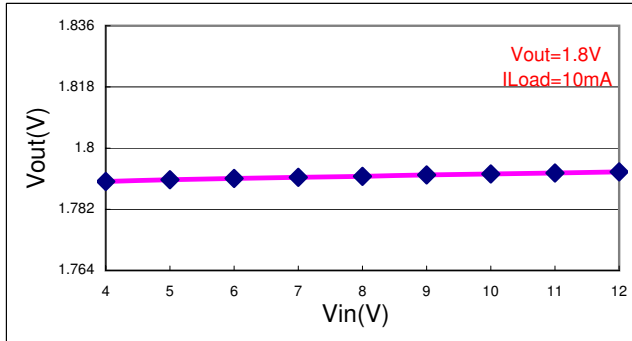

Load Regulation

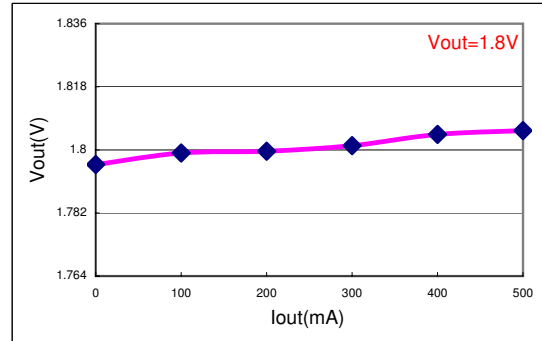

Load Transient



Line Transient

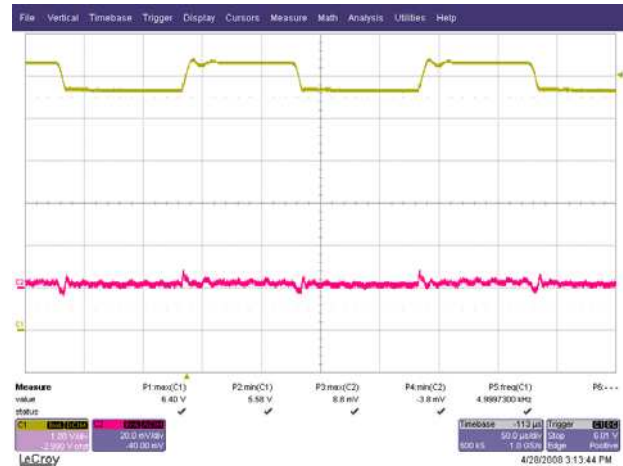

V_O VS I_O

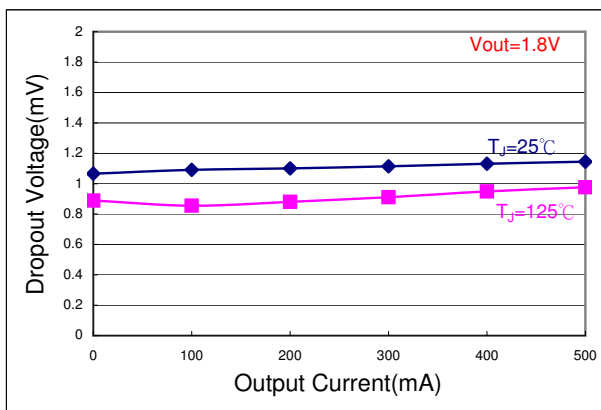

V_O VS TEMP.

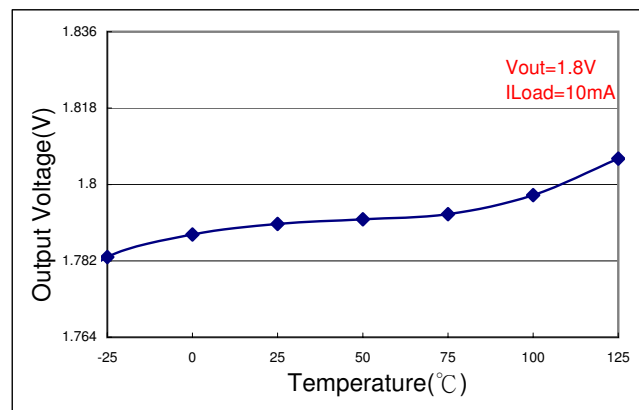



ADVANCED POWER ELECTRONICS CORP.

Package Outline : ESOP-8

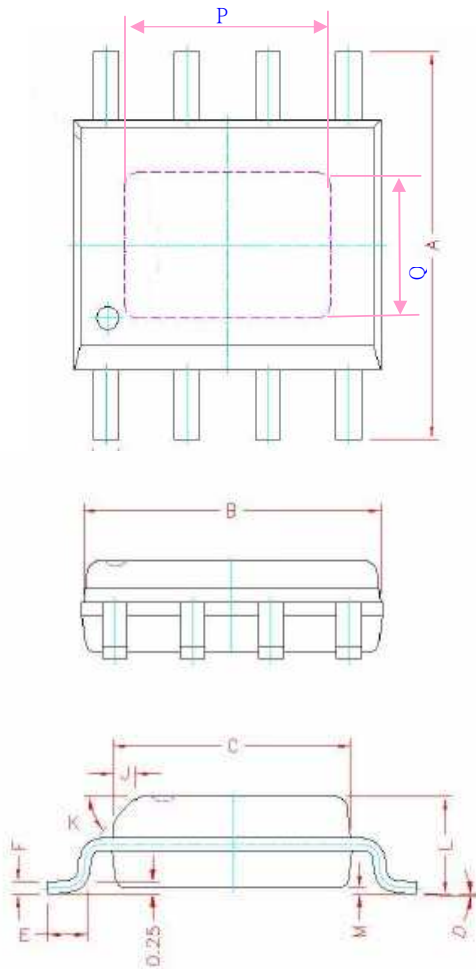

SYMBOLS	Millimeters		
	MIN	NOM	MAX
A	5.80	6.00	6.20
B	4.80	4.90	5.00
C	3.80	3.90	4.00
D	0°	4°	8°
E	0.40	0.65	0.90
F	0.19	0.22	0.25
M	0.00	0.08	0.15
H	0.35	0.42	0.49
L	1.35	1.55	1.75
J	0.375 REF.		
K	45°		
G	1.27 TYP.		
P	3.15	3.25	3.35
Q	2.25	2.35	2.45

- 1.All Dimension Are In Millimeters.
- 2.Dimension Does Not Include Mold Protrusions.

Part Marking Information & Packing : ESOP-8

