

- ▼ 100% Avalanche Test
- ▼ Fast Switching Characteristics
- ▼ Simple Drive Requirement

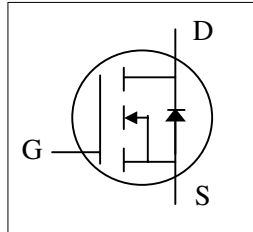

BV_{DSS}	650V
$R_{DS(ON)}$	1.4 Ω
I_D	7A

Description

AP2762 series are specially designed as main switching devices for universal 90~265VAC off-line AC/DC converter applications.

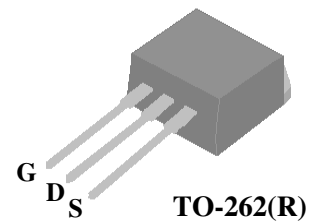

The TO-262 package is widely preferred for commercial-industrial applications. The device is suited for switch mode power supplies, DC-AC converters and high current high speed switching circuits.

Absolute Maximum Ratings

Symbol	Parameter	Rating	Units
V_{DS}	Drain-Source Voltage	650	V
V_{GS}	Gate-Source Voltage	± 30	V
$I_D@T_C=25^\circ C$	Continuous Drain Current, V_{GS} @ 10V	7	A
I_{DM}	Pulsed Drain Current ¹	24	A
$P_D@T_C=25^\circ C$	Total Power Dissipation	92.6	W
E_{AS}	Single Pulse Avalanche Energy ²	18	mJ
I_{AR}	Avalanche Current	6	A
T_{STG}	Storage Temperature Range	-55 to 150	$^\circ C$
T_J	Operating Junction Temperature Range	-55 to 150	$^\circ C$

Thermal Data

Symbol	Parameter	Value	Unit
R_{thj-c}	Maximum Thermal Resistance, Junction-case	1.35	$^\circ C/W$
R_{thj-a}	Maximum Thermal Resistance, Junction-ambient	62	$^\circ C/W$



Electrical Characteristics@T_j=25°C(unless otherwise specified)

Symbol	Parameter	Test Conditions	Min.	Typ.	Max.	Units
BV _{DSS}	Drain-Source Breakdown Voltage	V _{GS} =0V, I _D =1mA	650	-	-	V
R _{DS(ON)}	Static Drain-Source On-Resistance ³	V _{GS} =10V, I _D =3A	-	-	1.4	Ω
V _{GS(th)}	Gate Threshold Voltage	V _{DS} =V _{GS} , I _D =250uA	2	-	4	V
g _{fs}	Forward Transconductance	V _{DS} =10V, I _D =4A	-	3.5	-	S
I _{DSS}	Drain-Source Leakage Current	V _{DS} =480V, V _{GS} =0V	-	-	100	uA
I _{GSS}	Gate-Source Leakage	V _{GS} =±30V	-	-	±100	nA
Q _g	Total Gate Charge ³	I _D =6A	-	31	50	nC
Q _{gs}	Gate-Source Charge	V _{DS} =200V	-	7	-	nC
Q _{gd}	Gate-Drain ("Miller") Charge	V _{GS} =10V	-	13	-	nC
t _{d(on)}	Turn-on Delay Time ³	V _{DD} =200V	-	33	-	ns
t _r	Rise Time	I _D =3A	-	29	-	ns
t _{d(off)}	Turn-off Delay Time	R _G =50Ω, V _{GS} =10V	-	186	-	ns
t _f	Fall Time	R _D =67Ω	-	46	-	ns
C _{iss}	Input Capacitance	V _{GS} =0V	-	1330	2130	pF
C _{oss}	Output Capacitance	V _{DS} =30V	-	100	-	pF
C _{rss}	Reverse Transfer Capacitance	f=1.0MHz	-	8	-	pF

Source-Drain Diode

Symbol	Parameter	Test Conditions	Min.	Typ.	Max.	Units
V _{SD}	Forward On Voltage ³	I _S =6A, V _{GS} =0V	-	-	1.5	V
t _{rr}	Reverse Recovery Time ³	I _S =6A, V _{GS} =0V,	-	475	-	ns
Q _{rr}	Reverse Recovery Charge	di/dt=100A/μs	-	6.4	-	uC

Notes:

- 1.Pulse width limited by Max. junction temperature.
- 2.Starting T_j=25°C , V_{DD}=50V , L=1mH , R_G=25Ω
- 3.Pulse test

THIS PRODUCT IS AN ELECTROSTATIC SENSITIVE, PLEASE HANDLE WITH CAUTION.

THIS PRODUCT HAS BEEN QUALIFIED FOR CONSUMER MARKET. APPLICATIONS OR USES AS CRITERIAL COMPONENT IN LIFE SUPPORT DEVICE OR SYSTEM ARE NOT AUTHORIZED.

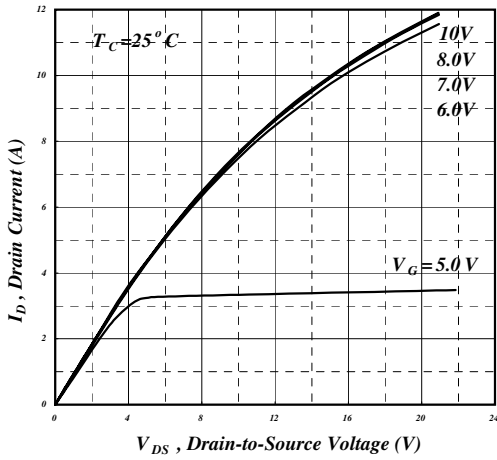

Fig 1. Typical Output Characteristics

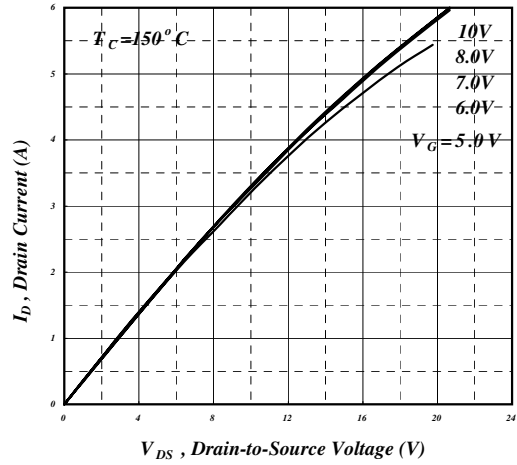

Fig 2. Typical Output Characteristics

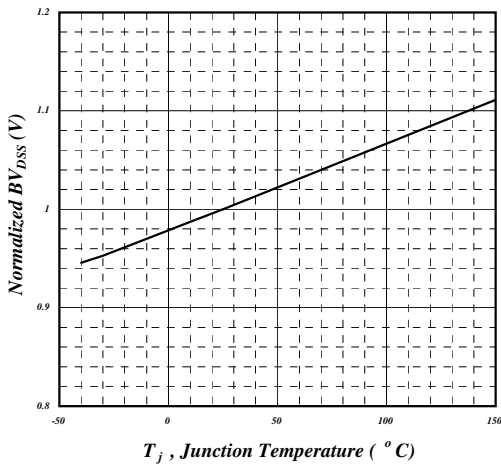

Fig 3. Normalized BV_{DSS} v.s. Junction Temperature

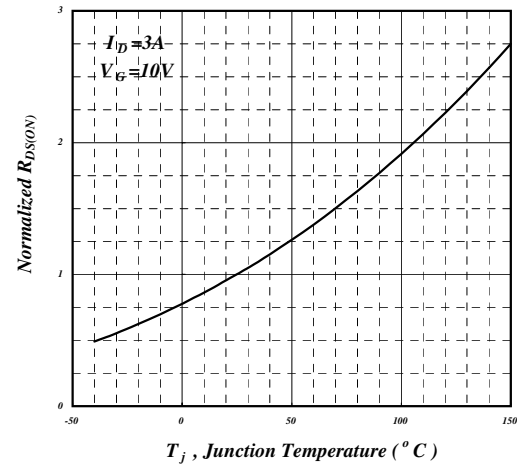

Fig 4. Normalized On-Resistance v.s. Junction Temperature

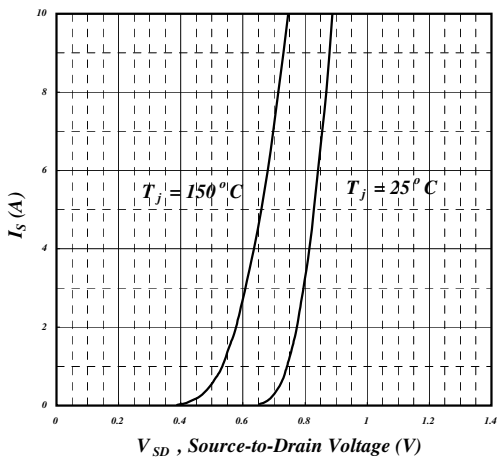

Fig 5. Forward Characteristic of Reverse Diode

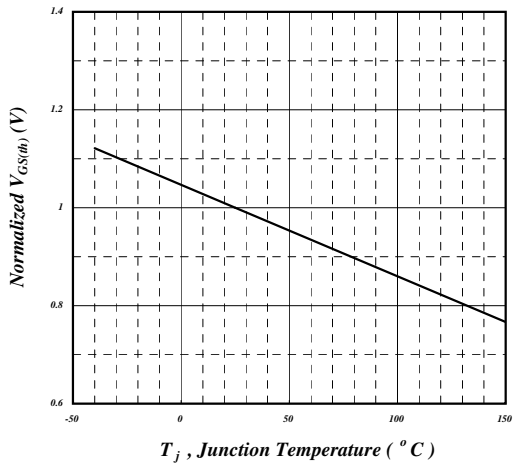

Fig 6. Gate Threshold Voltage v.s. Junction Temperature

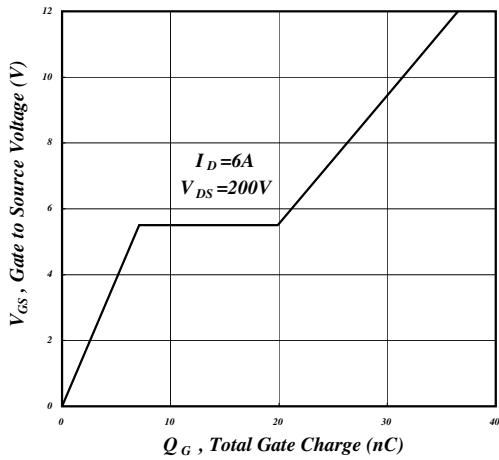

Fig 7. Gate Charge Characteristics

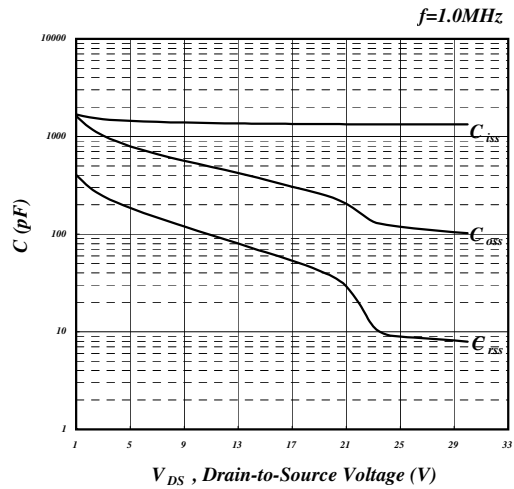

Fig 8. Typical Capacitance Characteristics

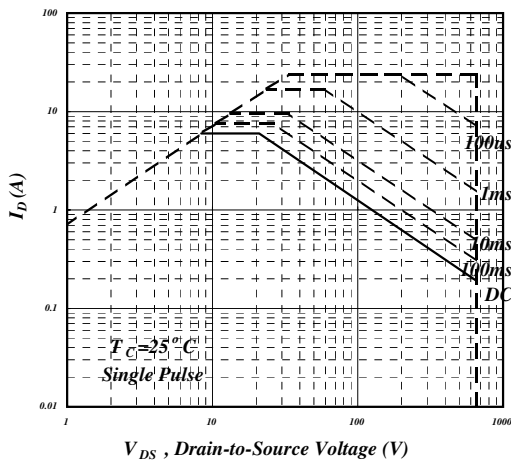

Fig 9. Maximum Safe Operating Area

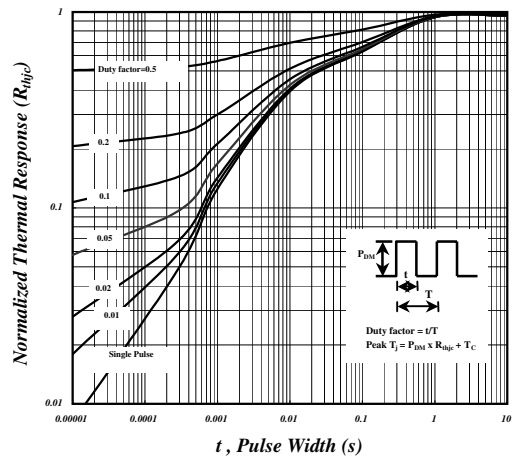

Fig 10. Effective Transient Thermal Impedance

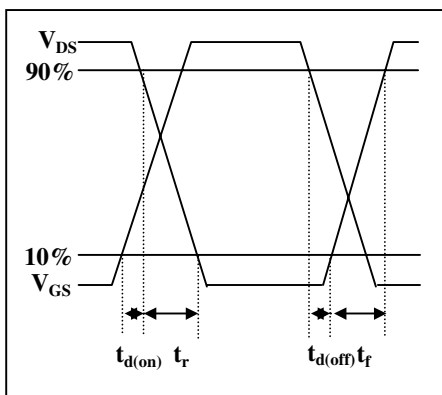

Fig 11. Switching Time Waveform

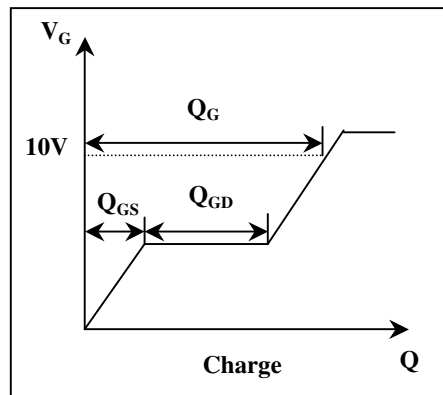
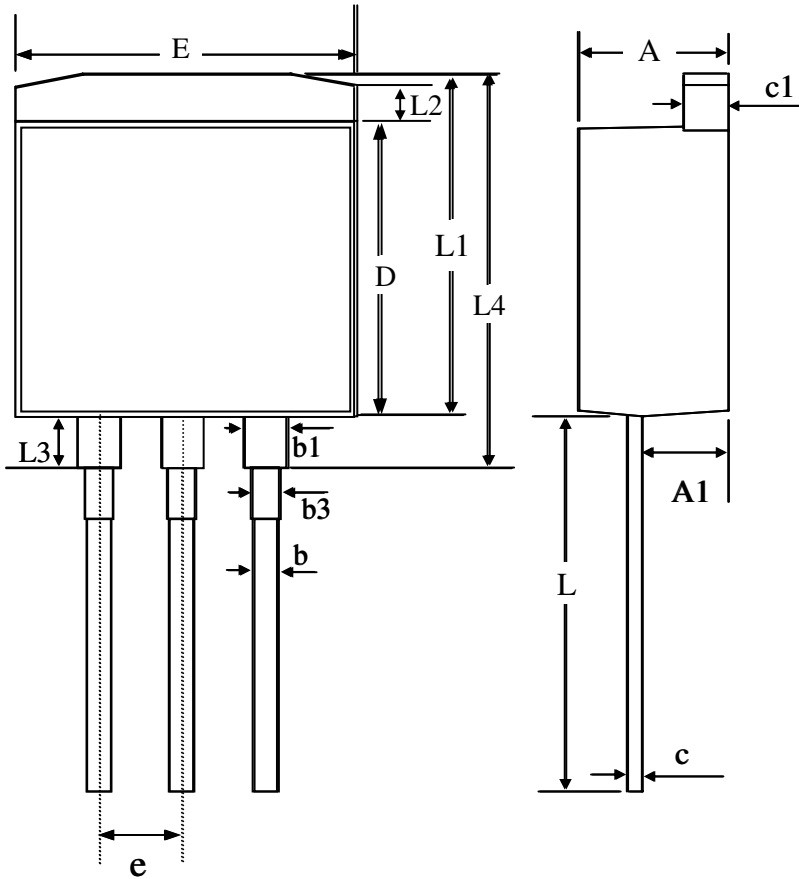

Fig 12. Gate Charge Waveform



Package Outline : TO-262



SYMBOLS	Millimeters		
	MIN	NOM	MAX
A	4.24	4.44	4.64
A1	-----	-----	2.70
b	0.66	0.76	0.86
b1	1.07	1.27	1.47
b3	0.76	0.86	1.06
c	0.30	0.40	0.50
c1	1.15	1.30	1.45
D	8.30	8.60	8.90
E	9.90	10.20	10.50
e	2.04	2.54	3.04
L	10.50	11.00	11.50
L1	9.50	10.00	10.30
L3	----	1.30	----
L4	10.80	11.30	11.35

- 1.All Dimensions Are in Millimeters.
- 2.Dimension Does Not Include Mold Protrusions.

Part Marking Information & Packing : TO-262

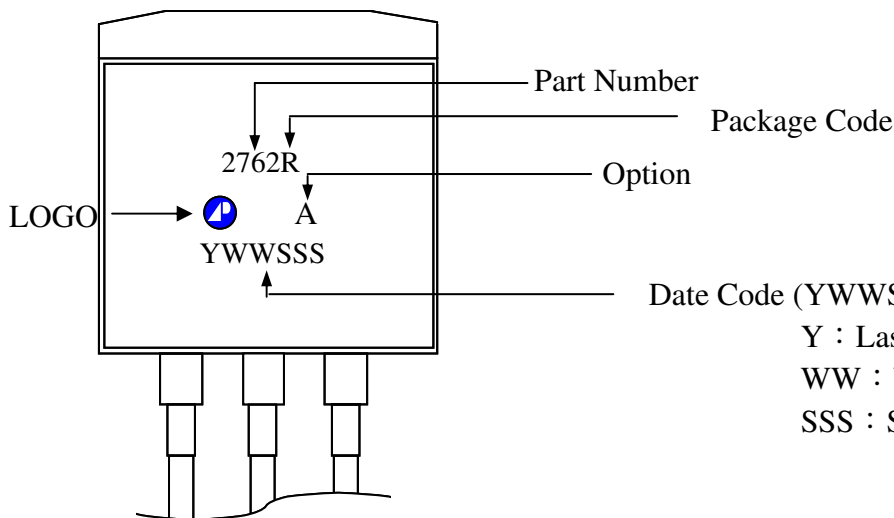

Date Code (YWWSSS)
 Y : Last Digit Of The Year
 WW : Week
 SSS : Sequence