

Absolute encoders - modular bus covers

Magnetic sensor bore max. $\varnothing 12$ mm

Magnetic single- or multiturn encoders / kit 12 bit ST / 18 bit MT

BMSK 58, BMMK 58 flexibel - MAGRES



BMMK 58 flexible kit

Features

- Encoder kit single- or multiturn / bus cover
- Magnetic sensing
- Resolution: singleturn 12 bit, multiturn 18 bit
- Modular fieldbus interfaces
- High resistance to shock and vibrations
- CANopen/DeviceNet/EtherCAT/EtherNet-IP/SAEJ1939
PROFINET/Power over EtherCAT/POWERLINK
Profibus
- Resolution and zero point programmable

Technical data - electrical ratings

Voltage supply	10...30 VDC
Consumption w/o load (typ.)	100 mA (24 VDC)
Initializing time (typ.)	170 ms after power on
Interfaces	CANopen, DeviceNet, EtherCAT, EtherNet/IP, PoE, Profibus-DPV0/V2, PROFINET, POWERLINK, SAEJ1939
User address	Rotary switch in bus cover
Steps per turn	≤ 4096 / 12 bit
Absolute accuracy	$\pm 1^\circ$
Sensing method	Magnetic
Code	Binary
Code sequence	CW default, programmable
Interference immunity	DIN EN 61000-6-2
Emitted interference	DIN EN 61000-6-3
Programmable parameters	Steps per revolution Number of revolutions Preset Scaling Rotational direction
Diagnostic functions	Position or parameter error Multiturn sensing
Status indicator	DUO-LED integrated in bus cover
Approval	UL approval / E217823
BMMK 58	
Function	Multiturn
Number of turns	≤ 262144 / 18 bit
BMSK 58	
Function	Singleturn

Technical data - mechanical design

Dimensions (flange)	$\varnothing 58$ mm
Shaft	Magnet hole 12 mm
Protection DIN EN 60529	IP 67
Operating speed	≤ 12000 rpm (mechanical) ≤ 6000 rpm (electric)
Materials	Housing: steel Flange: aluminium Bus cover: zinc die-cast
Operating temperature	$-20 \dots +85$ °C
Relative humidity	95 %
Resistance	DIN EN 60068-2-6 Vibration 30 g, 10-2000 Hz DIN EN 60068-2-27 Shock 200 g, 6 ms
Weight approx.	480 g
Connection	Bus cover
Gap tolerance	≤ 0.3 mm axial ≤ 0.1 mm radial

Absolute encoders - modular bus covers

Magnetic sensor bore max. $\varnothing 12$ mm
Magnetic single- or multiturn encoders / kit 12 bit ST / 18 bit MT

BMSK 58, BMMK 58 flexibel - MAGRES

Part number

Multiturn

BMMK 58S1N 12

			<u>Connection</u>
			D Complete encoder with bus cover / cable gland (w/o 246)
			G Basic encoder without bus cover
			E Complete encoder with bus cover, M12
			<u>Shaft</u>
	12		Magnet hole $\varnothing 12$ mm
			<u>Resolution</u>
12/18			12/18 bit single-/multiturn (only CANopen)
12/16			12/16 bit single-/multiturn
			<u>Voltage supply / signals</u>
24B	10...30 VDC		/ CANopen
24D	10...30 VDC		/ DeviceNet
24P	10...30 VDC		/ Profibus-DPV0
24Q	10...30 VDC		/ Profibus-DPV2
246	10...30 VDC		/ EtherCAT
24I	10...30 VDC		/ EtherNet/IP
242	10...30 VDC		/ Power over EtherCAT
24L	10...30 VDC		/ POWERLINK
24H	10...30 VDC		/ PROFINET
24J	10...30 VDC		/ SAEJ1939
24C	10...30 VDC		/ basic encoder

Singleturn

BMSK 58S1N 12/00 12

			<u>Connection</u>
			D Complete encoder with bus cover / cable gland (w/o 246)
			G Basic encoder without bus cover
			E Complete encoder with bus cover, M12
			<u>Shaft</u>
	12		Magnet hole $\varnothing 12$ mm
			<u>Resolution</u>
12/00			12 bit singleturn
			<u>Voltage supply / signals</u>
24B	10...30 VDC		/ CANopen
24D	10...30 VDC		/ DeviceNet
24P	10...30 VDC		/ Profibus-DPV0
24Q	10...30 VDC		/ Profibus-DPV2
246	10...30 VDC		/ EtherCAT
24I	10...30 VDC		/ EtherNet/IP
242	10...30 VDC		/ Power over EtherCAT
24L	10...30 VDC		/ POWERLINK
24H	10...30 VDC		/ PROFINET
24J	10...30 VDC		/ SAEJ1939
24C	10...30 VDC		/ basic encoder

CD with file descriptions is not included in the delivery. You may order them on CD as accessory free-of-charge under part number 10147362.

Absolute encoders - modular bus covers

Magnetic sensor bore max. $\varnothing 12$ mm

Magnetic single- or multiturn encoders / kit 12 bit ST / 18 bit MT

BMSK 58, BMMK 58 flexibel - MAGRES

Accessories

Connectors and cables

10160565	Cable connector/connector M12, EtherCAT, straight, 5 m
10137485	Female connector M12, 5-pin, A-coded, straight, shielded, 5 m
10144720	Female connector M12, 5-pin, A-coded, straight, shielded, 2 m
10153968	Female connector M12, 5-pin, A-coded, straight
10157909	Cable with male/female M12, Profibus, shielded, straight, B-coded, 2 m
10157910	Cable with male/female M12, Profibus, shielded, straight, B-coded, 5 m
10159389	Cable with male/female M12, Profibus, shielded, straight, B-coded, 0.3 m (stub line)
10157911	Cable with male/female M12, Profibus, shielded, angled, B-coded, 2 m
10157912	Cable with male/female M12, Profibus, shielded, angled, B-coded, 5 m

Mounting accessories

10110616	Clamp set $\varnothing 15$ mm
10112432	Hexagon wrench 2.5 mm

Programming accessories

10147362	CD-ROM with GSD-/EDS-/XML files and user manuals
----------	--

Dimensions

BMSK/BMMK 58 flexible encoder with bus cover

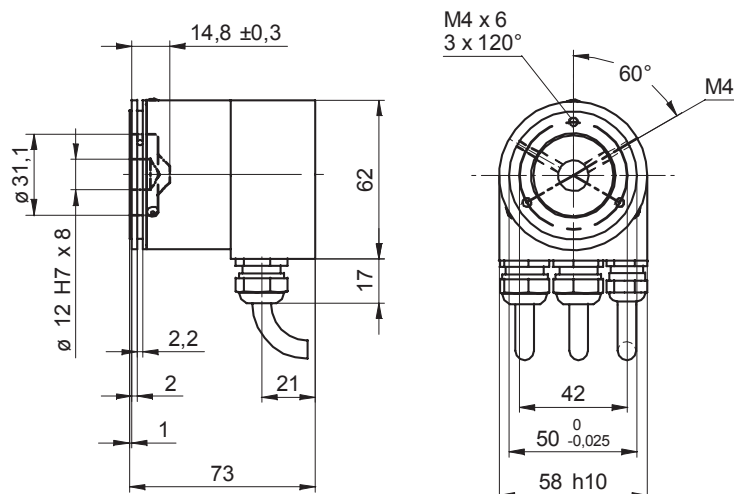

Absolute encoders - modular bus covers

Magnetic sensor bore max. $\varnothing 12$ mm

Magnetic single- or multiturn encoders / kit 12 bit ST / 18 bit MT

BMSK 58, BMMK 58 flexibel - MAGRES

Dimensions

Profibus-DP/CANopen

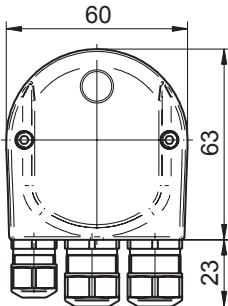

Profibus-DP - M12

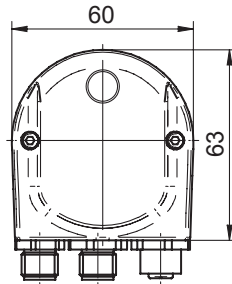

DeviceNet

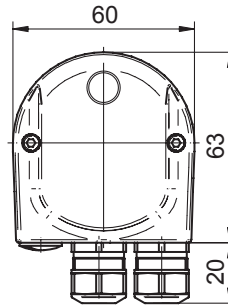

CANopen/DeviceNet M12

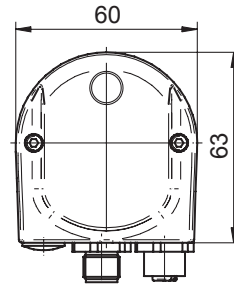

EtherCAT/EtherNet-IP

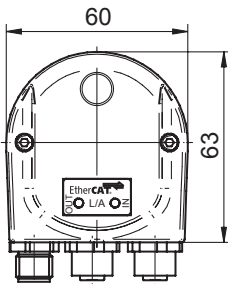

Power over EtherCAT

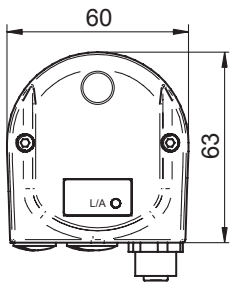

PROFINET/POWERLINK

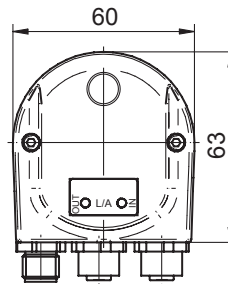

SAEJ1939

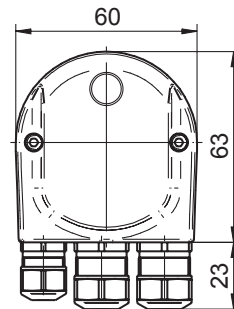

SAEJ1939 - M12

