

6: EMC / HF Gaskets

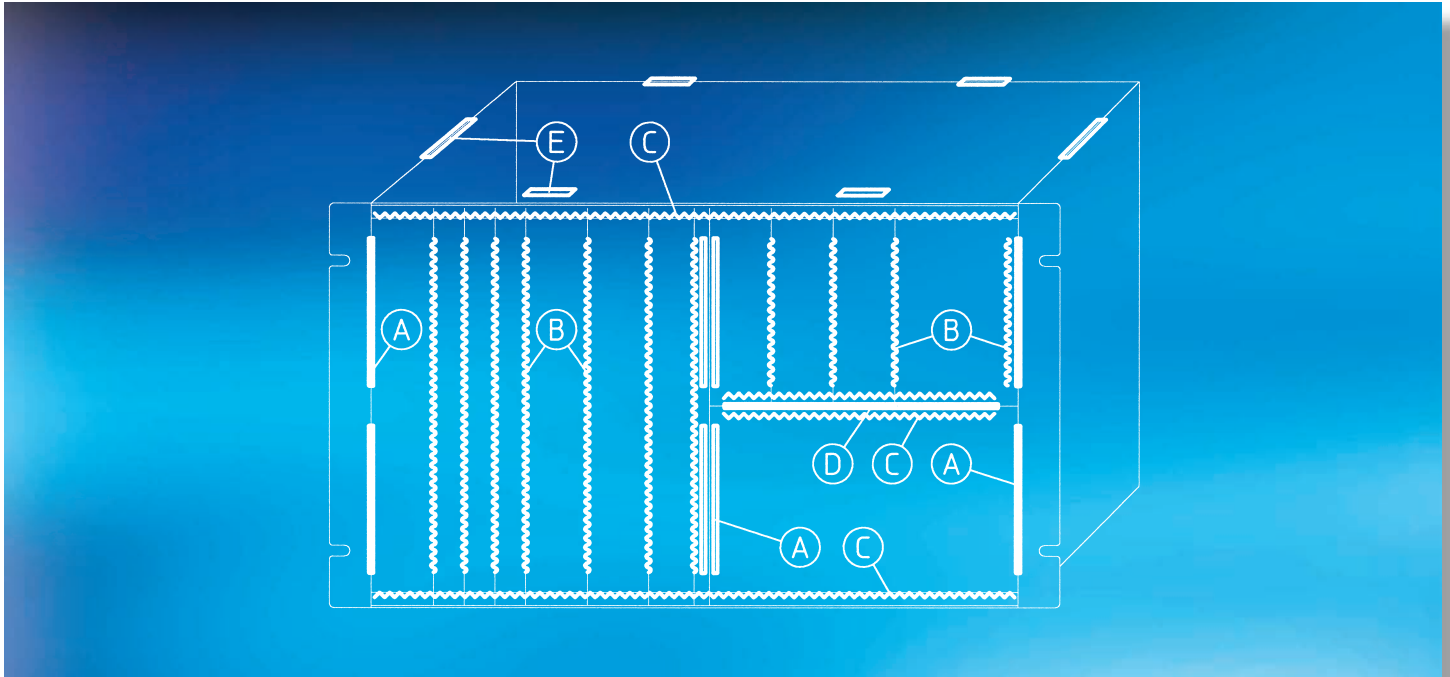

6.1 EMC / HF Gaskets

6.1.1 EMC Contact Springs (A)



6.1.1 EMC Contact Springs (A)

- Stainless steel
- Side front panel to end side panel
- EMC dividing extrusion 66-266
- Self-adhesive

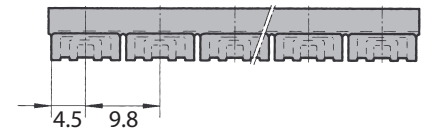
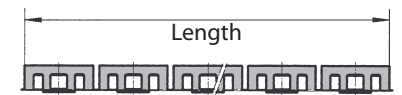
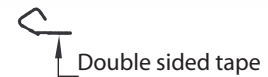

For Size	Length		Packing Units	Part-No.
	mm	inch		
2 U	58	2.32	2 pcs.	63-873-03
3 U	107	4.28	2 pcs.	63-873-01
6 U	2 x 107	2 x 4.28	4 pcs.	63-873-02
4 U	146.2	5.385	2 pcs.	63-873-04
6 U	244.2	9.77	2 pcs.	63-873-05
7 U	283.4	11.34	2 pcs.	63-873-06

6.1.2 EMC Contact Strips (A)



6.1.2 EMC Contact Strips (A)

- BeCu galvanized
- Side front panel to end side panel
- Self-adhesive

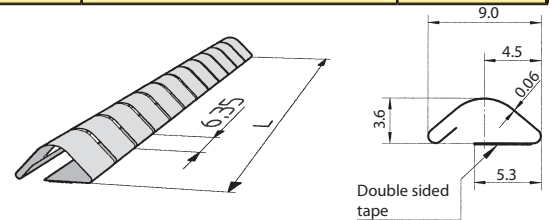

Division	For Size	Length		Packing Units	Part-No.
		mm	inch		
5	-	31.8	1.27	2 pcs.	63-836-51
10	2 U	63.5	2.54	2 pcs.	63-836-52
17	3 U	108	4.32	2 pcs.	63-836-53
24	4 U	152.4	6.00	2 pcs.	63-836-54
38	6 U	241.3	9.65	2 pcs.	63-836-56
45	7 U	285.8	11.42	1 pc.	61-800-07
66	10 U / 84 HP	419.1	16.76	1 pc.	61-800-10

6: EMC / HF Gaskets

6.1.3 HF Gaskets (A)

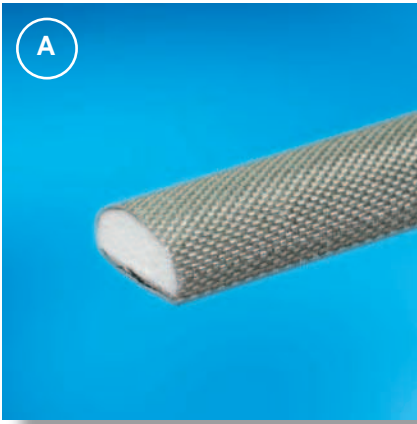

6.1.3.1 HF Gaskets (A)

- D-shaped
- Polyurethane foam core
- Conductive fabric (Ni+Cu plated)
- Self-adhesive

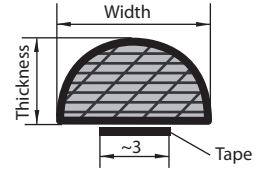

Width		Thickness		Length		Packing Units	Part-No.
mm	inch	mm	inch	mm	inch		
6.35	0.25	3.56	0.14	142.5	5.6	1 pc.	7820-90
				245.0	9.65	1 pc.	7820-91
				88.0	3.46	1 pc.	7820-92

6.1.4 EMC Gaskets (B) Stainless Steel



6.1.4 EMC Gasket (A and B)

- Stainless steel

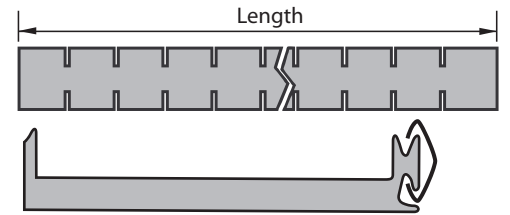

For size	Length		Packing Units	Part-No.
	mm	inch		
3 U	101.6	4.00	1 pc.	81-062-03
			10 pcs.	81-062-03-1
			100 pcs.	81-062-03-2
4 U	146.05	5.75	1 pc.	81-062-04
			10 pcs.	81-062-04-1
			100 pcs.	81-062-04-2
6 U	234.95	9.25	1 pc.	81-062-06
			10 pcs.	81-062-06-1
			100 pcs.	81-062-06-2
7 U	279.4	11.00	1 pc.	81-062-07
			10 pcs.	81-062-07-1
			100 pcs.	81-062-07-2
8 U	323.85	12.75	1 pc.	81-062-08
			10 pcs.	81-062-08-1
			100 pcs.	81-062-08-1
9 U	368.3	14.50	1 pc.	81-062-09
			10 pcs.	81-062-09-1
			100 pcs.	81-062-09-2

6.1.5 EMC Gaskets (B) Foam Core

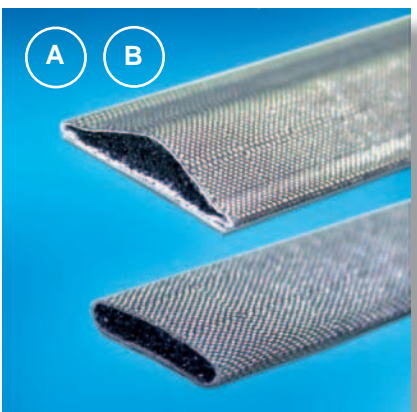

6.1.5 EMC-Gaskets (B)

- Polyurethane foam core
- Conductive fabric (Ni+Cu plated)
- Self-adhesive

Description	Part-No.
EMC-gasket rectangular. 2.0 x 7 mm, L = 300 mm	7820-95
EMC-gasket triangular. 2.3 x 10 mm, L = 300 mm	7821-300
EMC-gasket triangular. 2.3 x 10 mm, L = 2000 mm	7821-2000

6: EMC / HF Gaskets

6.1.6 EMC Contact Strips (B)

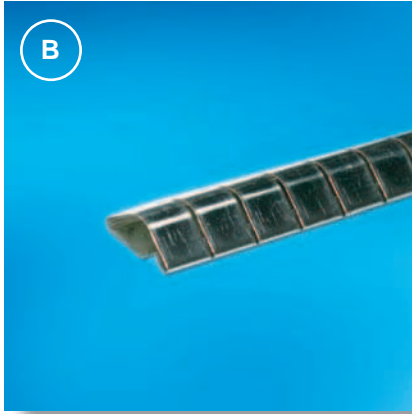

6.1.6 EMC Contact Strips (B)

- BeCu galvanized
- For part front panels
- Self-adhesive

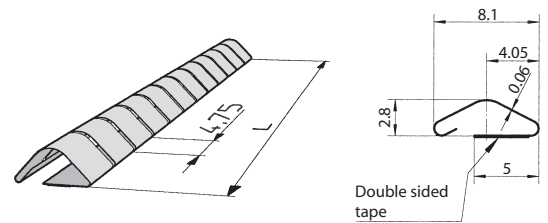

Division	For Size	Length		Packing Units	Part-No.
		mm	inch		
17	3 U	80.4	3.16	1 pc.	7738-13
45	6 U	213.4	8.40	1 pc.	7738-16

6.1.7 HF Spring (C)

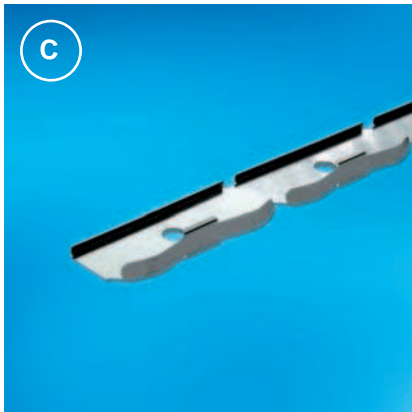

6.1.7 HF Spring (C)

- Stainless steel
- Snapped-in on the extrusion
- **Scope of delivery:**
 - 2 pcs. HF spring 84 HP

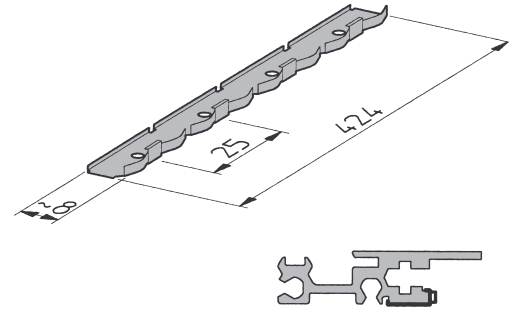

Description	Part-No.
1 set of 2 HF spring 84 HP	7739-14-4

6.1.8 EMC Contact Strips (C)



6.1.8 EMC Contact Strips (C)

- BeCu galvanized
- For front panels, fixing on extrusion
- Self-adhesive
- **Scope of delivery:**
 - 2 pcs. EMC contact strips

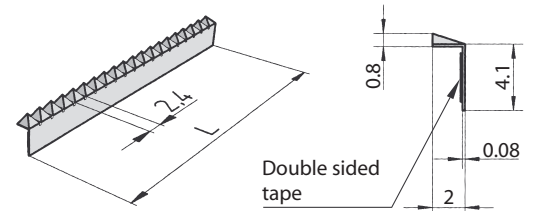

For HP	Length		Part-No.
	mm	inch	
42	212.1	8.35	63-836-67
63	318.1	12.52	63-836-68
84	424.2	16.70	63-836-70

6.1.9 EMC Contact Strips(D)



6.1.9 EMC Contact Strips (D)

- BeCu galvanized
- Self-adhesive

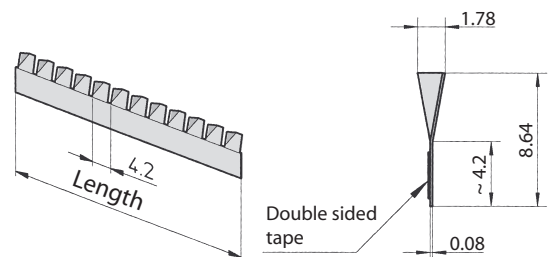

Division	For Size	Length		Packing Units	Part-No.
		mm	inch		
52	42 HP	217.93	8.58	1 pc.	7739-35
103	84 HP	431.55	16.99	1 pc.	7739-37

6: EMC / HF Gaskets



6.1.9.1 EMC Contact Strips

- For fixing on flat front panels
- Self-adhesive

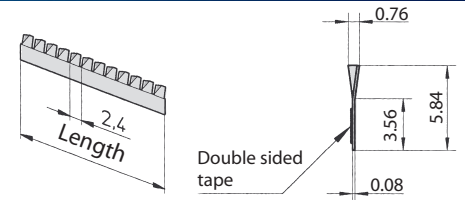

Division	For Size	Length		Packing Units	Part-No.
		mm	inch		
12	-	29	1.14	1 pc.	7739-31
178	84 HP	429.5	16.91	1 pc.	63-836-80

6.1.10 HF Gasket



6.1.10 HF Gasket

- Neoprene foam core
- Aluminium cover
- Self-adhesive

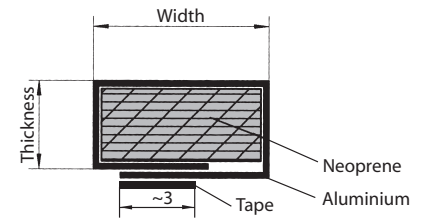

6.1.11 Sealing Gasket

- For higher IP-protection and EMC shielding in one
- Conductive sealing
- **Scope of delivery:**
 - 1 sealing gasket (conductive)

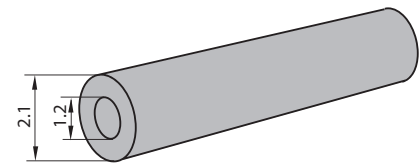

6.1.11 Sealing Gasket

Description	Part-No.
Sealing gasket conductive, length 700 mm	33E025

