



- Quartz SAW Stabilized and Filtered "Diff Sine" Technology
- Fundamental-Mode Oscillation at 672.163 MHz
- Voltage Tunable for Phase Lock Loop Operations
- Optical Timing Reference for Forward Error Correction Applications
- Complies with Directive 2002/95/EC (RoHS)



**OP4009B**

**672.163 MHz  
Optical  
Timing Clock**

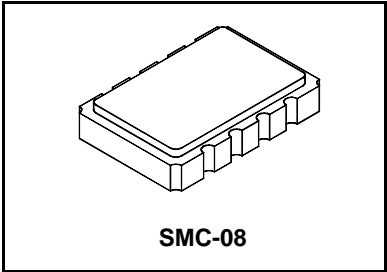

The output of this device is generated and filtered by narrowband quartz SAW elements at 672.163 MHz. The configuration of this clock is intended to provide a pure signal for optical timing applications in noisy signal environments. The Q/Qbar differential output swing of  $\pm 1$  volt about 0 Vdc has symmetry better than  $\pm 1\%$  into loads from 40 to 70 ohms; determined by customer application. The long term frequency accuracy is set by an external reference source allowing this device to complete a Phase Lock Loop design without the usual noise and jitter problems associated with PLL's.

**Absolute Maximum Ratings**

Rating	Value	Units
DC Supply Voltage	0 to 5.5	Vdc
Tuning Voltage	0 to 5.5	Vdc
Case Temperature	-55 to 100	°C

**Electrical Characteristics**

Characteristic	Sym	Notes	Minimum	Typical	Maximum	Units		
Operating Frequency	Absolute Frequency	$f_O$	1, 9	672.163		MHz		
		Tuning Range	2	$\pm 100$		ppm		
		Tuning Voltage	1	0		+3	V	
		Tuning Linearity	1, 8		$\pm 3$	$\pm 5$	%	
		Tuning Sensitivity	df/dv	2, 10	140		300	ppm/V
		Modulation Bandwidth			125	265		kHz
Q and $\bar{Q}$ Output	Voltage into 50 $\Omega$ (VSWR $\leq$ 1.2)	$V_O$	1, 3	0.60		1.1	$V_{P-P}$	
		Operating Load VSWR	1, 3			2:1		
		Symmetry	3, 4, 5	49		51	%	
		Harmonic Spurious	3, 4, 6			-30	dBc	
		Nonharmonic Spurious	3, 4, 6, 7			-60	dBc	
Phase Noise	@100 Hz offset			-75		dBc/Hz		
		@1 kHz offset			-105		dBc/Hz	
		@10 kHz offset			-125		dBc/Hz	
		Noise Floor			-155		dBc/Hz	
Q and $\bar{Q}$ Jitter	RMS Jitter		3, 4, 6, 7	2		ps <sub>P-P</sub>		
		No Noise on $V_{CC}$	3, 4, 6, 7	12		ps <sub>P-P</sub>		
		200 mV <sub>P-P</sub> from 1 MHz to $\frac{1}{2} f_O$ on	3	12		ps <sub>P-P</sub>		
Input Impedance (Tuning Port)			1			K $\Omega$		
Output DC Resistance (between Q & $\bar{Q}$ )		1, 3	50			K $\Omega$		
DC Power Supply	Operating Voltage	$V_{CC}$	1, 3	3.13	3.3, 5.0	5.25	Vdc	
		Operating Current	$I_{CC}$	1, 3			70	mA
Operating Case Temperature		$T_C$	1, 3	-40		+85	°C	
Lid Symbolization (YY=Year, WW=Week)	RFM OP4009B YYWW							



**CAUTION: Electrostatic Sensitive Device. Observe precautions for handling.**  
**COCOM CAUTION: Approval by the U.S. Department of Commerce is required prior to export of this device.**

**Notes:**

1. Unless otherwise noted, all specifications include any combination of load VSWR, Vcc, and temperature, with Q and  $\bar{Q}$  terminated into 50 ohm loads to ground (see typical test circuit).
2. Useful tuning range is in excess of what is required over temp, aging, pushing, pulling & accuracy.
3. The design, manufacturing process, and specifications of this device are subject to change without notice.
4. Only under the nominal conditions of 50  $\Omega$  load impedance with VSWR  $\leq$  1.2 and nominal power supply voltage.
5. Symmetry is defined as the pulse width (in percent of total period) measured at the 50% points of Q or  $\bar{Q}$  (see timing definitions).
6. Jitter and other spurious outputs induced by externally generated electrical noise on  $V_{CC}$  or mechanical vibration are not included in this specification, except where noted. External voltage regulation and careful PCB layout are recommended for optimum performance.
7. Applies to period jitter of Q and  $\bar{Q}$ . Measurements are made with the Tektronix CSA803 signal analyzer with at least 1000 samples.
8. Linearity is a function of the percentage variation from a permitted linear deviation versus the amount of frequency tuning range (see *linearity definition*).
9. One or more of the following United States patents apply: 4,616,197; 4,670,681; 4,760,352.

## OP Performance Curves and Application Information

See the OP4005B Data Sheet for typical OP performance curves and application information.

### SMC-8 8-Terminal Surface Mount Case

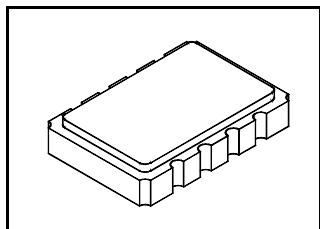

#### BLOCK DIAGRAM

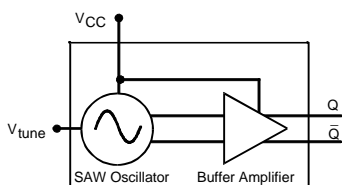

Dimension	mm		Inches	
	MIN	MAX	MIN	MAX
A	13.46	13.97	0.530	0.550
B	9.14	9.66	0.360	0.380
C	1.93 Nominal		0.076 Nominal	
D	3.56 Nominal		0.141 Nominal	
E	2.24 Nominal		0.088 Nominal	
F	1.27 Nominal		0.050 Nominal	
G	2.54 Nominal		0.100 Nominal	
H	3.05 Nominal		0.120 Nominal	
J	1.93 Nominal		0.076 Nominal	
K	5.54 Nominal		0.218 Nominal	
L	4.32 Nominal		0.170 Nominal	
M	4.83 Nominal		0.190 Nominal	
N	0.50 Nominal		0.020 Nominal	

#### ELECTRICAL CONNECTIONS

Terminal Number	Connection
1	V <sub>CC</sub>
2	Ground
3	Enable/Disable
4	Q Output
5	$\bar{Q}$ Output
6	Ground
7	
8	TUNE Input
LID	Ground

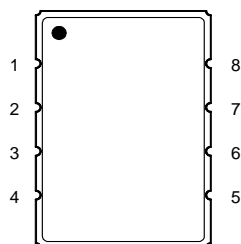

TOP VIEW

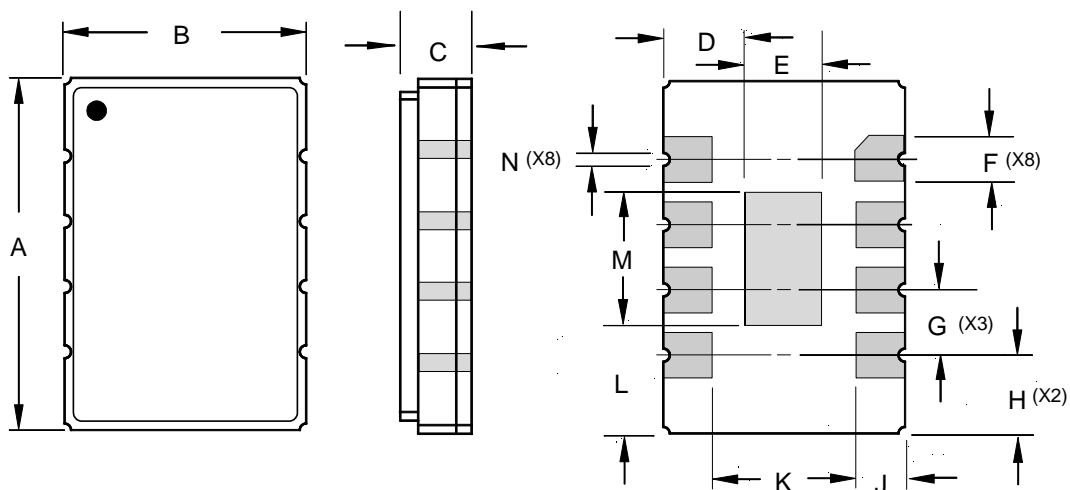

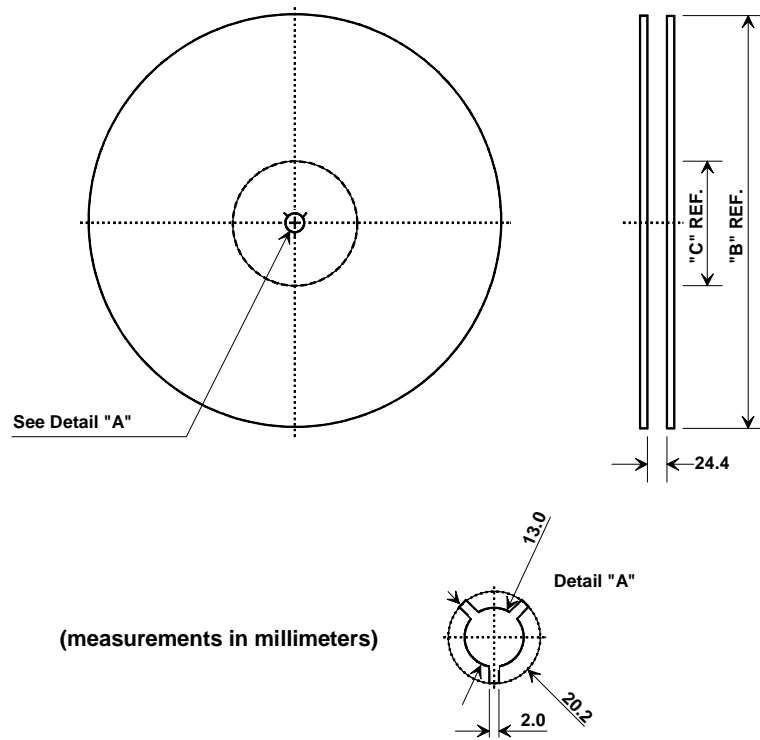

(measurements in millimeters)

**SMC-08 Case**

Reel Size		Quantity Per Reel	
"B" Nominal	"C" Nominal	Min	Max
13 Inch	330 mm	200	1000

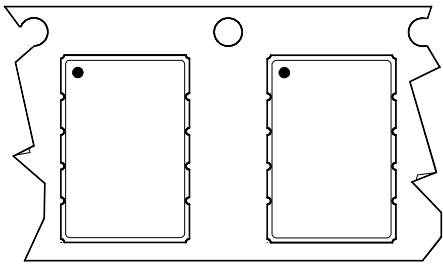

Orientation in Tape Carrier as Shipped

**Dimensions**

Carrier Tape Dimensions		Cover Tape Size
<b>Ao</b>	.383 ± .004 (9.7 mm)	
<b>Bo</b>	.554 ± .004 (14.1 mm)	
<b>Ko</b>	.130 ± .004 (3.3 mm )	
<b>P</b>	12 mm	
<b>W</b>	24 mm	
<b>Tape Length</b>	60 m	
<b>Pockets/m</b>	83	

