

Preliminary



- Low-loss SAW Filter
- Single-ended Input, Balanced Output
- Excellent Rejection
- 1.45 x 1.15 mm Surface-Mount Case
- Complies with Directive 2002/95/EC (RoHS)



SF2212K

**1902 MHz
SAW Filter**

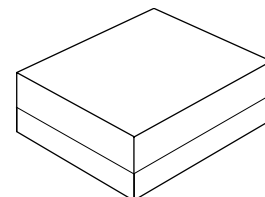

SM1411-5

Absolute Maximum Ratings

Rating	Value	Units
Maximum Incident Power in Passband	+10	dBm
Maximum DC Voltage On any Non-ground Terminal	3	VDC
Operating Temperature Range	-20 to +75	°C
Storage Temperature Range in Tape and Reel	-30 to +85	°C
Maximum Soldering Temperature Profile (5 cycles maximum)	265 °C for 10 s	

Electrical Characteristics

Characteristic	Sym	Notes	Min	Typ	Max	Units
Center Frequency	f_C			1902		MHz
Insertion Loss, 1884.55 to 1919.45 MHz	IL_{MAX}			1.8	2.4	dB
Amplitude Ripple, 1884.55 to 1919.45 MHz				0.5	1.0	dB _{P-P}
Output Amplitude Balance, $ S_{31} / S_{21} $			-3	+1.9	+3	dB
Output Phase Balance, $Phase(S_{31}) - Phase(S_{21}) + 180^\circ$			-12	+6	12	deg
Rejection Referenced to 0 dB						
1349 to 1455 MHz			35	40		dB
1614 to 1687 MHz			35	46		
1731 to 1801 MHz			34	36		
1986 to 2056 MHz			18	22		
2037 to 2039 MHz			25	33		
2113 to 2186 MHz			35	42		
2386 to 2451 MHz			40	48		
3000 to 3840 MHz			40	51		
4941 to 5760 MHz			35	48		
VSWR, 1884.55 to 1919.45 MHz				2.0 : 1	2.5 : 1	
Terminating Source impedance	Z_S			50		Ω
Terminating Balanced Load impedance	Z_L		200 Ω 22 nH			
Case Style			SM1411-5			
Lid Symbolization (V = week character)			7V			



CAUTION: Electrostatic Sensitive Device. Observe precautions for handling.

Notes:

1. US and international patents may apply.
2. RFM, stylized RFM logo, and RF Monolithics, Inc. are registered trademarks of RF Monolithics, Inc.

Frequency Response Plots

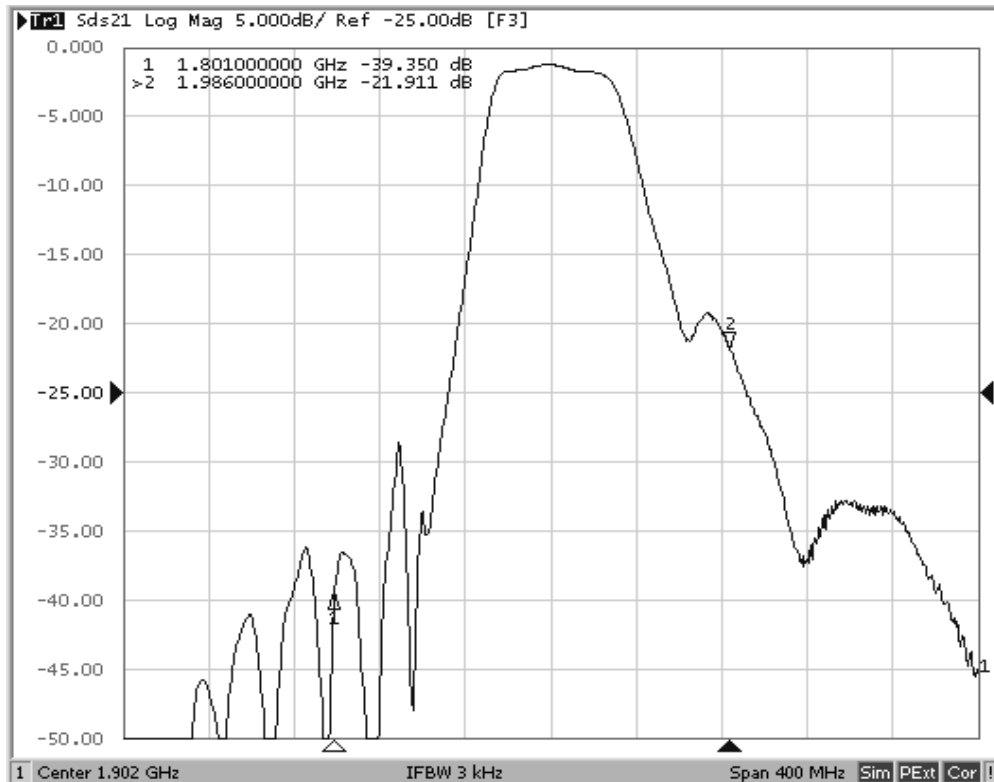
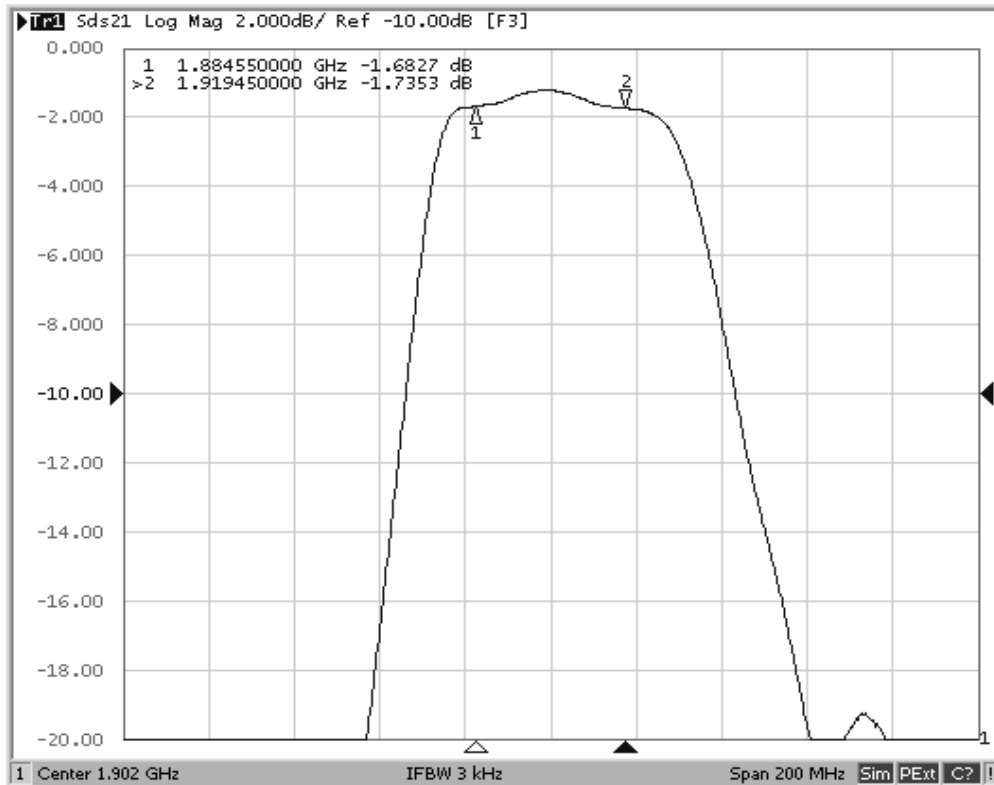

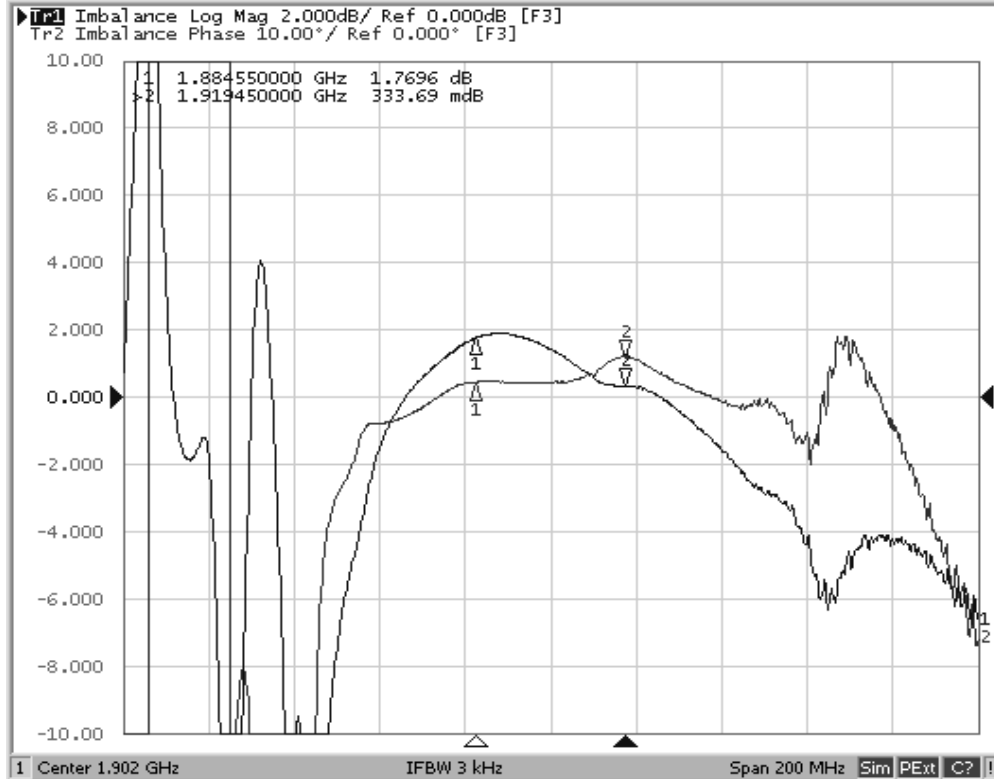
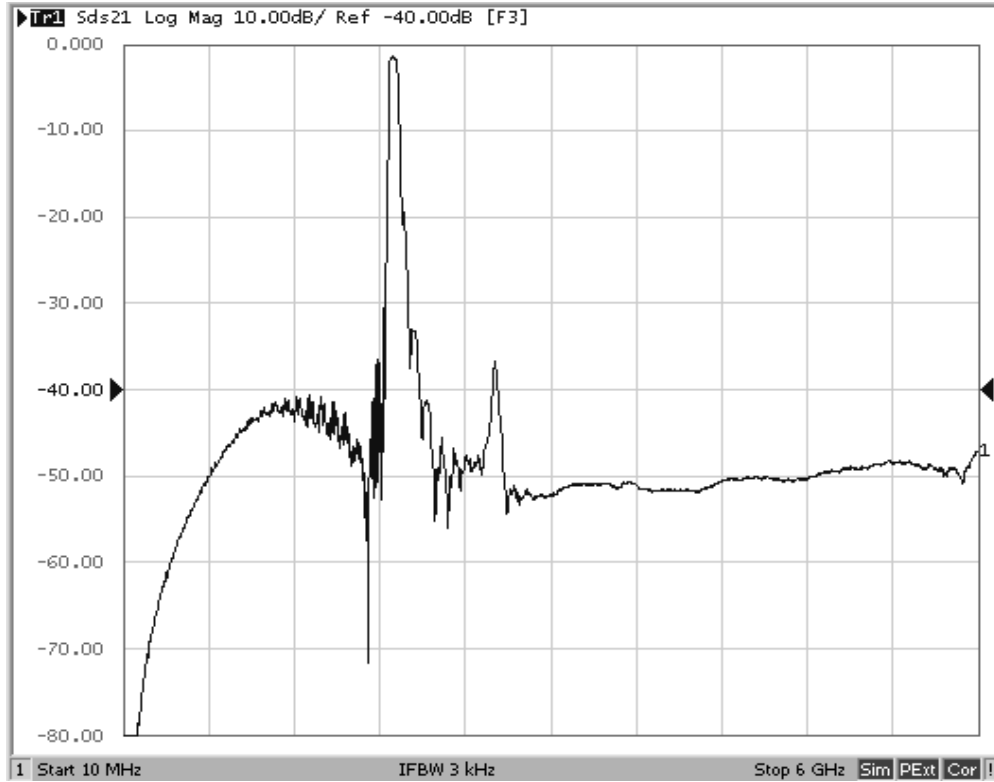

50 ohm Input VSWR Plot

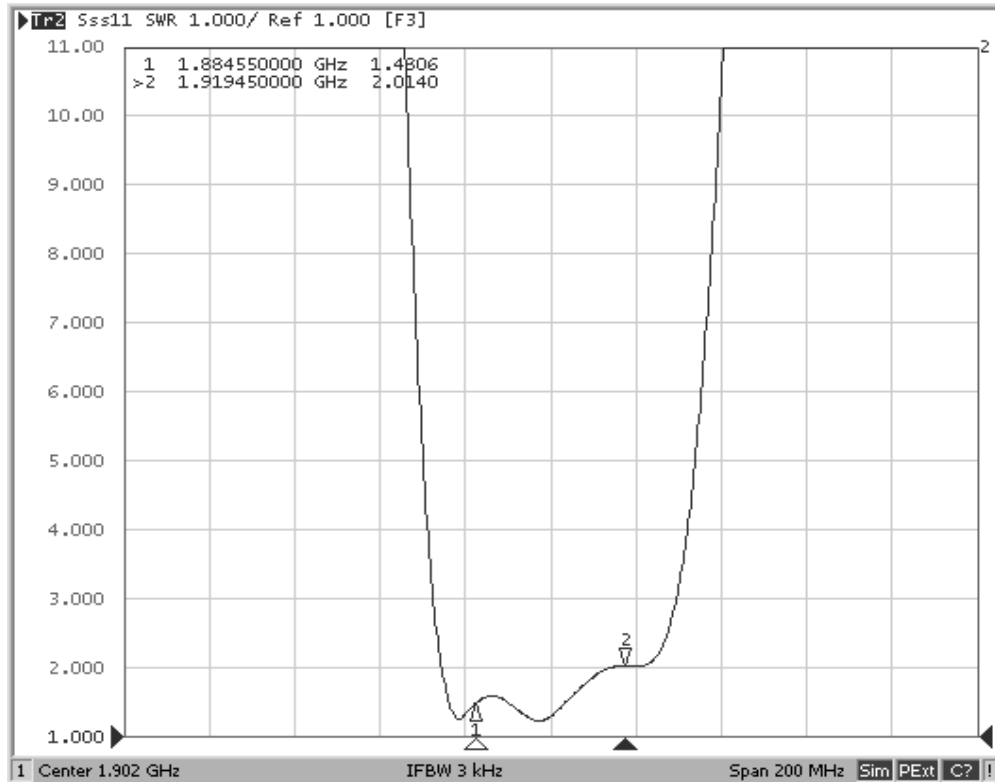

200 ohm Balanced Output VSWR Plot

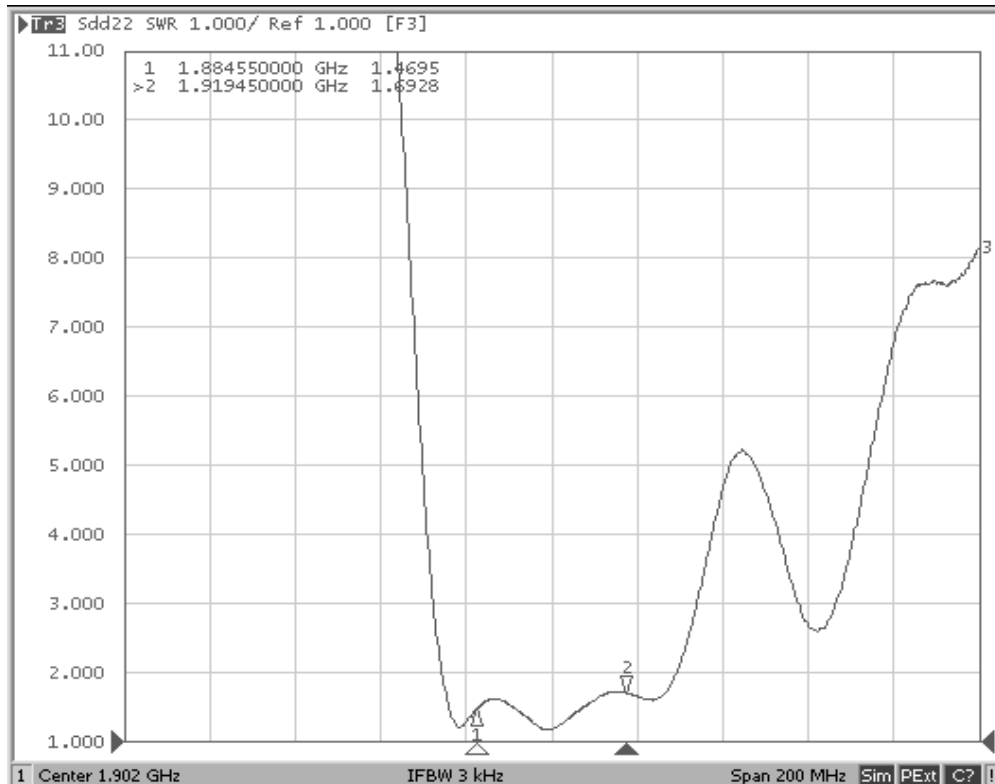

SM1411-5 Case

5-Terminal Surface-Mount Case 1.45 X 1.15- mm Nominal Footprint

Electrical Connections

Connection	Terminals
Single-ended Input	C
Balanced Output	A, E
Ground	B, D

Package Dimensions

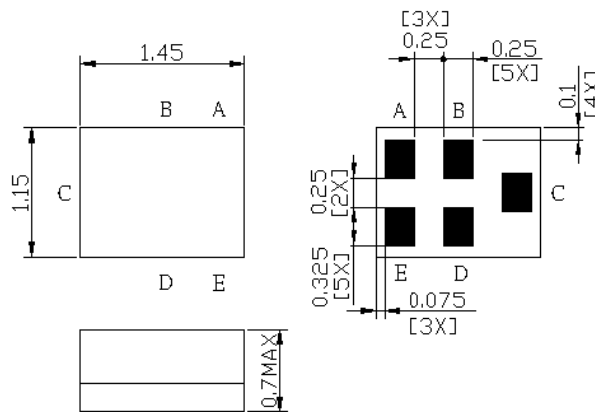

Circuit Board Footprint

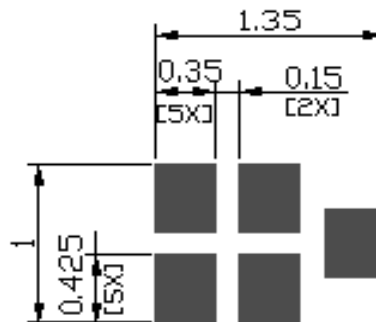

Test Circuit

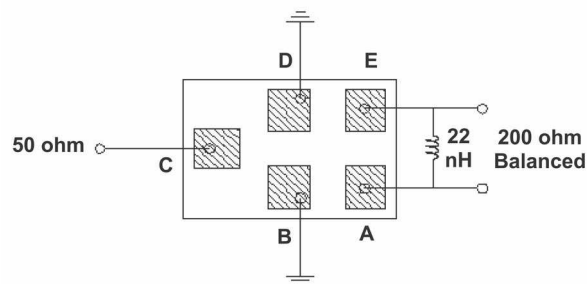

Reel Dimensions - 7 inch Reel, 3000 Filters

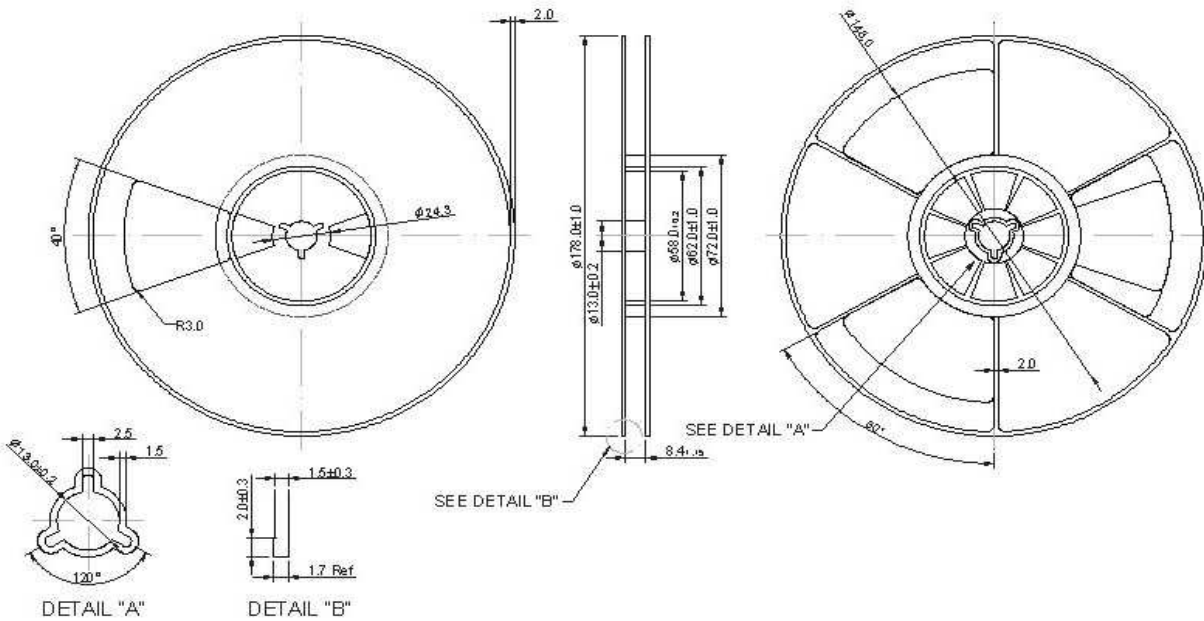

Tape Dimensions

