

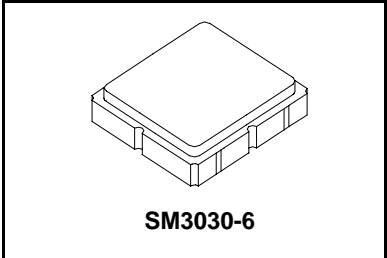

SF1186B-2

**1575.42 MHz
SAW Filter**



- *Designed for Front-end GPS Applications*
- *Low Insertion Loss*
- *3.0 x 3.0 x 1.3 mm Surface-mount Case*
- *No Matching Network Required*
- *Complies with Directive 2002/95/EC (RoHS)*

Maximum Ratings at +25 °C unless stated otherwise

Rating	Symbol	Value	Units
Maximum Input Signal Level		+10	dBm
DC Voltage on any Non-ground Terminal	WVdc	4	Volts
Storage Temperature Range	T _{STG}	-40 to +105	°C
Lead Soldering Temperature for 10 Seconds	T _{WAVE}	260	°C
Peak Reflow Solder Temp for 40 Seconds	T _{Reflow}	235	°C
Suitable for Lead-free Soldering - Max Soldering Temperature		260°C for 30 s	

Electrical Characteristics

Characteristic	Sym	Notes	Min	Typ	Max	Units
Center Frequency	f _O	1	1575.42			MHz
1 dB Bandwidth	BW ₁	1	2.046	15.3		MHz
Passband Amplitude Ripple, f _O ±2.0 MHz				0.1	1.0	dB _{P-P}
Passband Group Delay				27		ns
Passband Group Delay Ripple, f _O ±2.0 MHz				1		ns _{P-P}
Passband VSWR, f _O ±2.0 MHz				1.4	2.0	
Insertion Loss		1		2.68	3.5	dB
Attenuation Referenced to 0 dB:						
850 MHz		1	45	51.2		dB
1500 MHz		1	40	52.7		
1535.42 MHz		1	20	38.9		
1615.42 MHz		1	20	58.8		
1640 MHz		1	45	59.1		
1700 MHz		1	50	56.7		
Temperature Coefficient			-30			ppm/°C
Operating Temperature	T _A	1	-40		+85	°C
Single-ended Input /Output Impedance Match	No matching network required for operation at 50 ohms					
Case Style	SM3030-6 3 x 3 mm Nominal Footprint					
Lid Symbolization	y=year, ww=week, s=shift	468 YWWS				
Standard Reel Quantity	Reel Size 7 Inch	6	500 Pieces/Reel			
	Reel Size 13 Inch		3000 Pieces/Reel			

Electrical Connections

Pin #	Description	Pin #	Description
1	Ground	4	Ground
2	Input	5	Output
3	Ground	6	Ground



CAUTION: Electrostatic Sensitive Device. Observe precautions for handling.

Notes:

- | | |
|--|--|
| <ol style="list-style-type: none"> 1. Unless noted otherwise, all specifications apply over the operating temperature range with filter soldered to the specified demonstration board without impedance matching and measured with 50 Ω network analyzer. 2. The design, manufacturing process, and specifications of this filter are subject to change. 3. Either Port 1 or Port 2 may be used for either input or output in the design. However, impedances and impedance matching may vary between Port 1 and Port 2, so that the filter must always be installed in one direction per the circuit design. | <ol style="list-style-type: none"> 4. US and international patents may apply. 5. RFM, stylized RFM logo, and RF Monolithics, Inc. are registered trademarks of RF Monolithics, Inc. 6. Tape and Reel Standard Per ANSI/EIA 481. |
|--|--|

Transfer function :

(1) S21 response (span : 300 MHz)

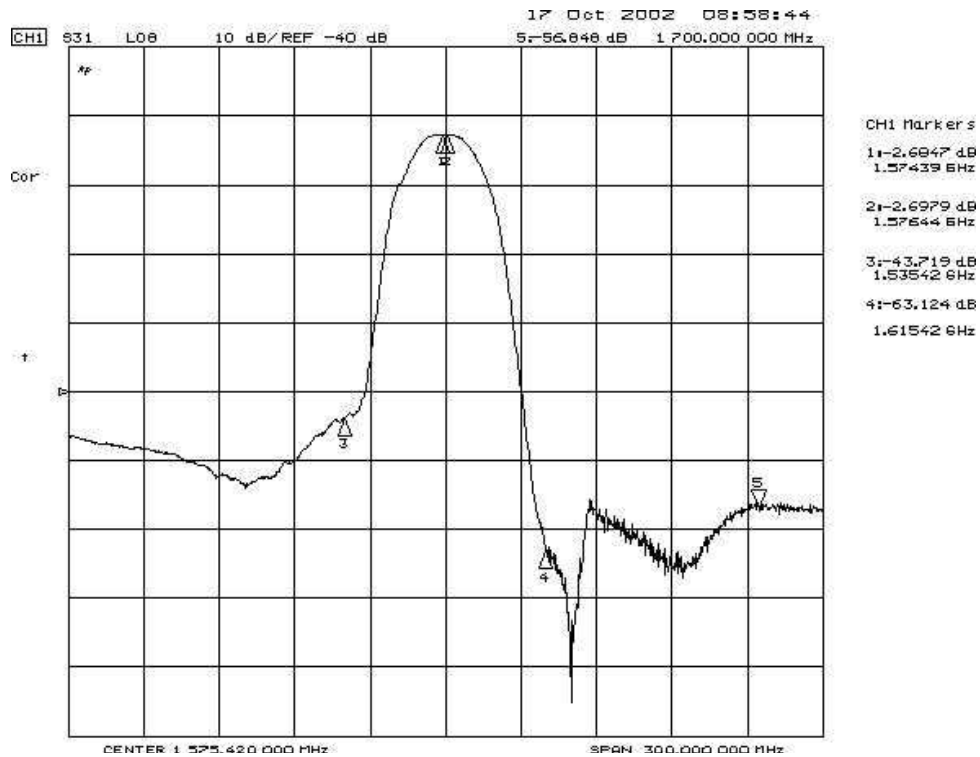

(2) S21 response (span : 3 GHz)

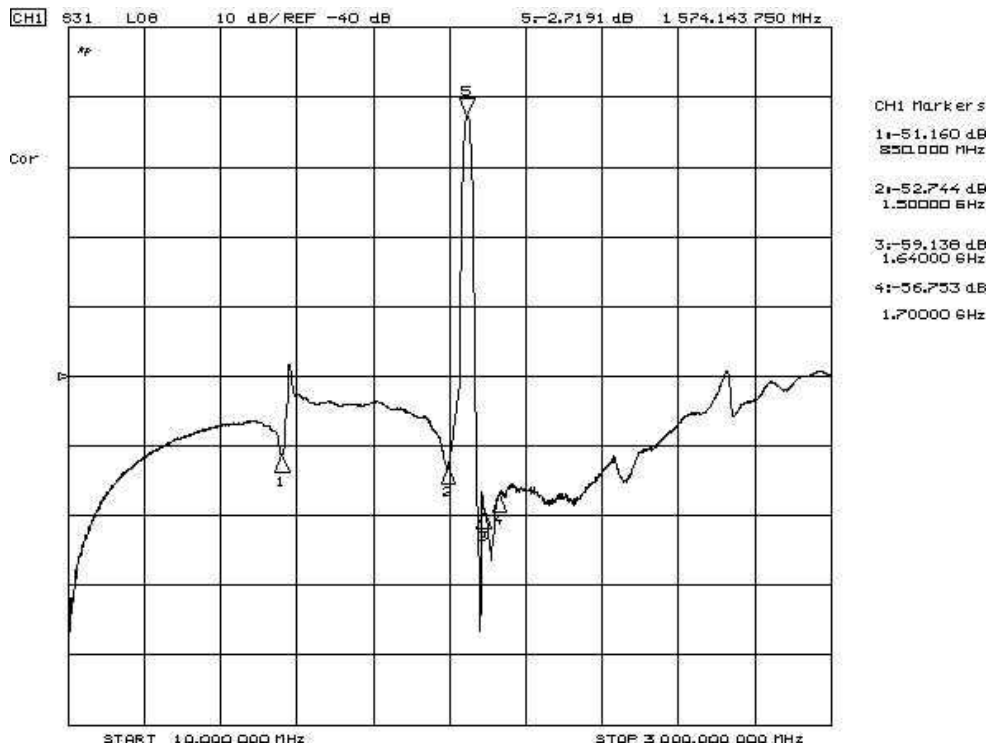

Reflection Functions:

S11

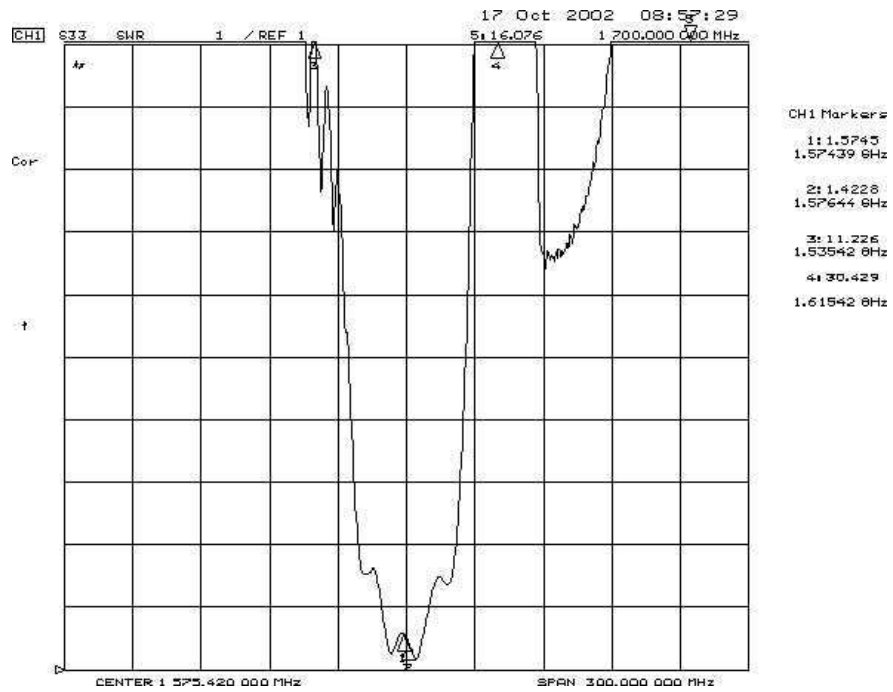

S22

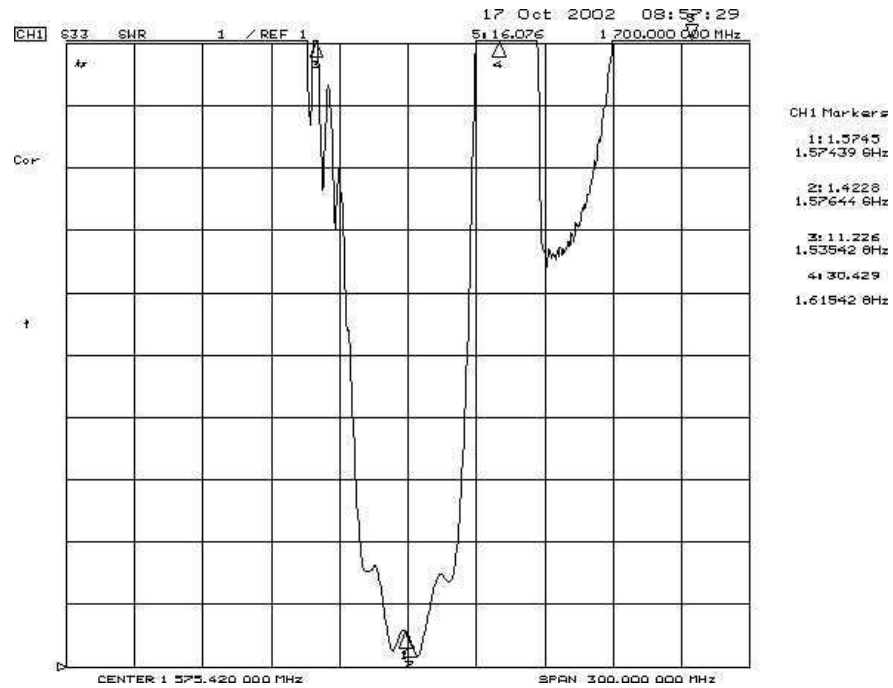

Reflection Functions:

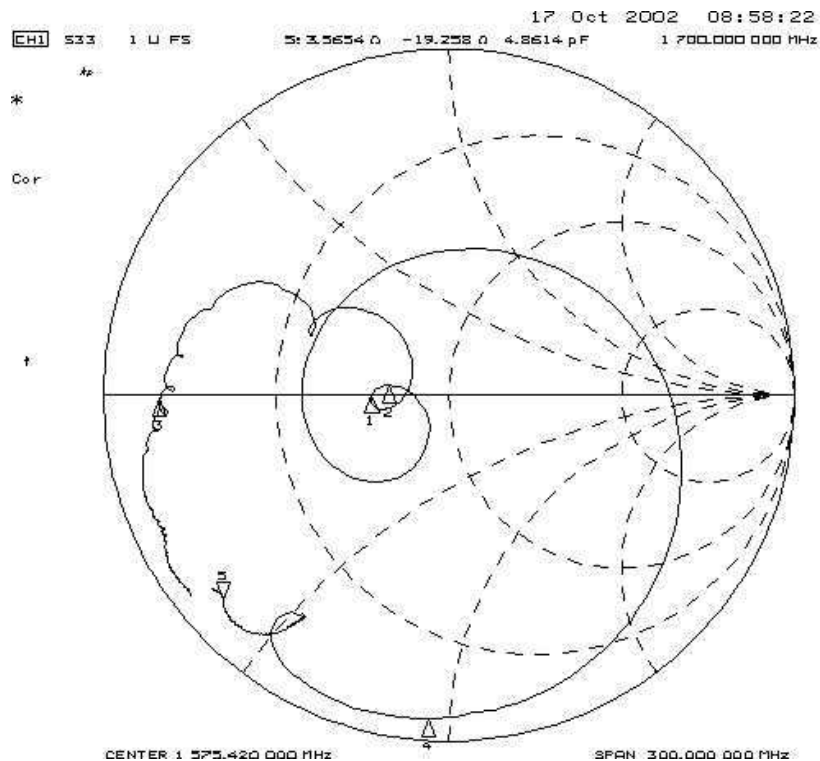
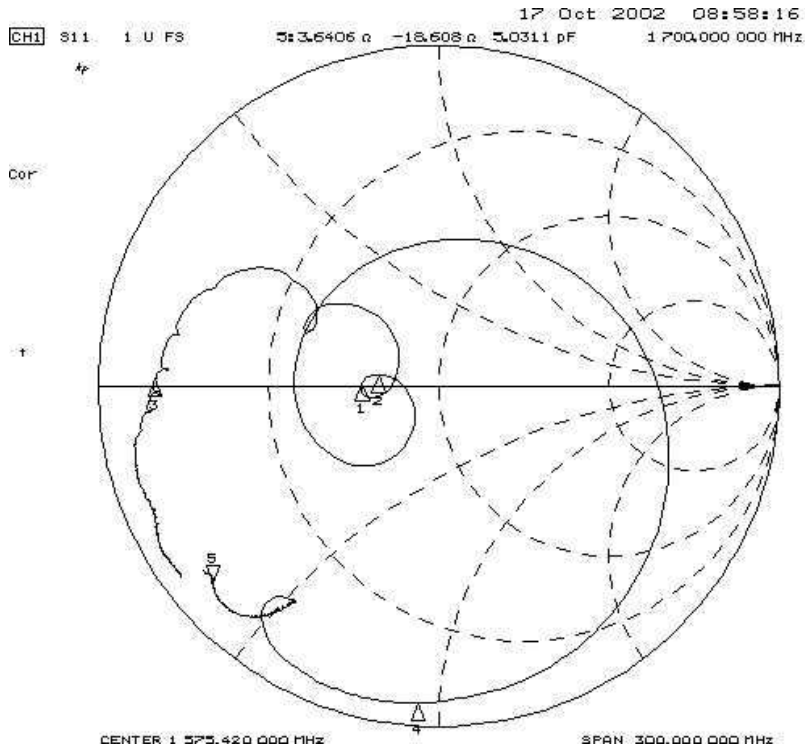

Group Delay:

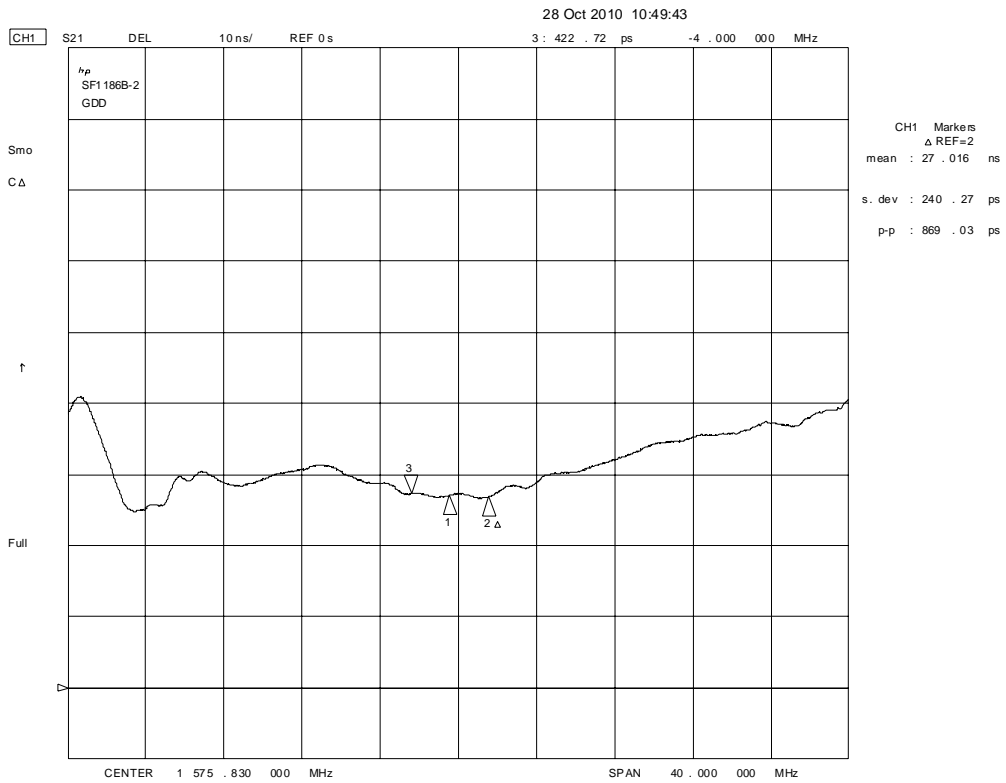

SM3030-6 Case

6-Terminal Ceramic Surface-Mount Case

3.0 X 3.0 mm Nominal Footprint

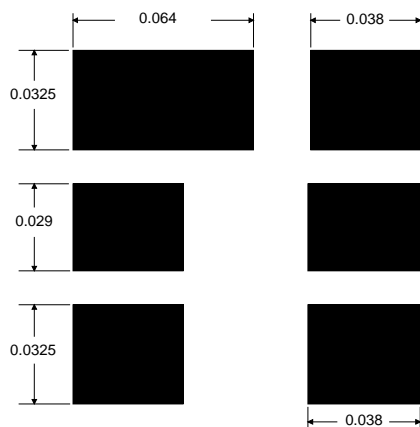
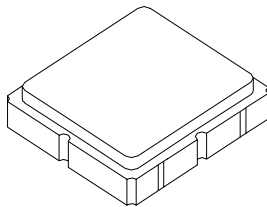

Foot Print Dimensions in Nominal Inches

Case Dimensions						
Dimension	mm			Inches		
	Min	Nom	Max	Min	Nom	Max
A	2.87	3.0	3.13	0.113	0.118	0.123
B	2.87	3.0	3.13	0.113	0.118	0.123
C	1.12	1.25	1.38	0.044	0.049	0.054
D	0.77	0.9	1.03	0.030	0.035	0.040
E	2.67	2.80	2.93	0.105	0.110	0.115
F	1.47	1.6	1.73	0.058	0.063	0.068
G	0.72	0.85	0.98	0.028	0.033	0.038
H	1.37	1.5	1.63	0.054	0.059	0.064
I	0.47	0.6	0.73	0.019	0.024	0.029
J	1.17	1.3	1.43	0.046	0.051	0.056

Electrical Connections		
Connection		Terminals
Port 1	Single-ended Input	2
Port 2	Single-ended Output	5
	Ground	All others
Single-ended Operation Only		
Dot indicates Pin 1		

Case Materials	
Solder Pad Plating	0.3 to 1.0 μm Gold over 1.27 to 8.89 μm Nickel
Lid Plating	2.0 to 3.0 μm Nickel
Body	Al_2O_3 Ceramic
Pb Free	

TOP VIEW

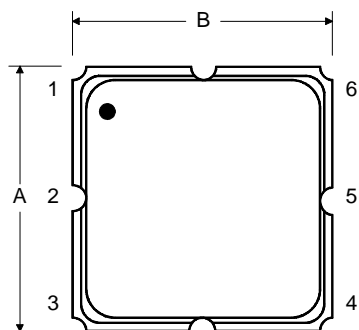

BOTTOM VIEW

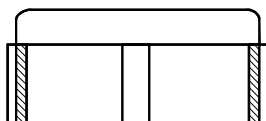
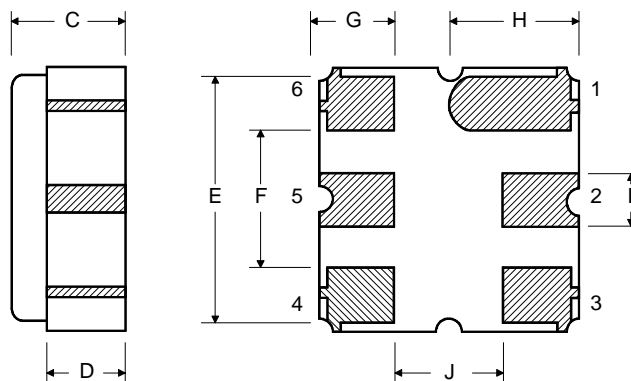

Tape and Reel Specifications

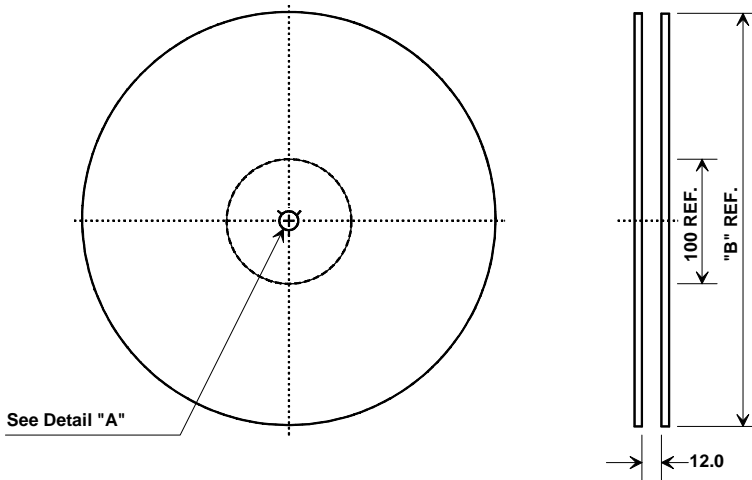

"B"		Quantity Per Reel
Inches	millimeters	
7	178	500
13	330	3000

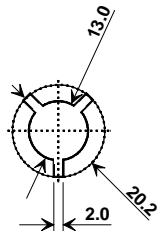

COMPONENT ORIENTATION

