



Preliminary

SF2270A

70 MHz SAW Filter

- Precision SAW IF Filter
- Hermetic 13.3 x 6.5 mm Surface-mount Case
- Complies with Directive 2002/95/EC (RoHS)



Absolute Maximum Ratings

Rating	Value	Units
Maximum Incident Power in Passband	+20	dBm
Maximum DC Voltage on any Non-ground Terminal	3	VDC
Storage Temperature Range in Tape and Reel	-40 to +85	°C
Suitable for Lead-free Soldering - Maximum Soldering Profile	260 °C for 30 s	

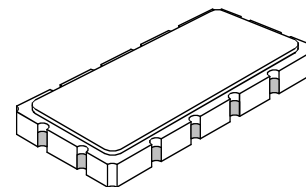

Case

Electrical Characteristics

Characteristic	Sym	Notes	Min	Typ	Max	Units
Center Frequency	f_C	1	69.85	70.00	70.15	MHz
Insertion Loss	IL	1		7.5	8.2	dB
1 dB Bandwidth	BW_1	1	2.30	2.63		MHz
3 dB Bandwidth	BW_3	1	3.00	3.55		MHz
35 dB Bandwidth	BW_{35}	1		6.0	7.5	MHz
Amplitude Ripple, $f_C \pm 0.92$ MHz		1, 2, 3		0.75	1.00	dB _{p-p}
RMS Phase Linearity, $f_C \pm 1.2$ MHz				2.2	5.0	ns
Group Delay Ripple, $f_C \pm 1.2$ MHz				155	190	ns _{p-p}
Absolute Delay				1.07		µs
Attenuation Referenced to IL:						dB
10 to 66 MHz			40	45		
74 to 140 MHz			40	45		
Operating Temperature Range		1	-10		+70	°C

Impedance Matching to 50 Ω Unbalanced Source/Load	External L-C
Case Style	13.3 x 6.5 mm Nominal Footprint
Lid Symbolization (YY = year, WW = week)	RFM/SF2270A/YYWW



CAUTION: Electrostatic Sensitive Device. Observe precautions for handling.

Notes:

1. Unless noted otherwise, all specifications apply over the operating temperature range with filter soldered to the specified demonstration board with impedance matching to 50 Ω and measured with 50 Ω network analyzer.
2. Unless noted otherwise, all frequency specifications are referenced to the nominal center frequency, f_C .
3. Rejection is measured as attenuation below the minimum IL point in the passband. Rejection in final user application is dependent on PCB layout and external impedance matching design. See Application Note No. 42 for details.
4. Part to part absolute delay measurement records the absolute delay mean across 1 dB passband.
5. "LRIP" or "L" after the part number indicates "low rate initial production" and "ENG" or "E" indicates "engineering prototypes."
6. The design, manufacturing process, and specifications of this filter are subject to change.
7. Either Port 1 or Port 2 may be used for either input or output in the design. However, impedances and impedance matching may vary between Port 1 and Port 2, so that the filter must always be installed in one direction per the circuit design.
8. US and international patents may apply.

Overall Filter Response

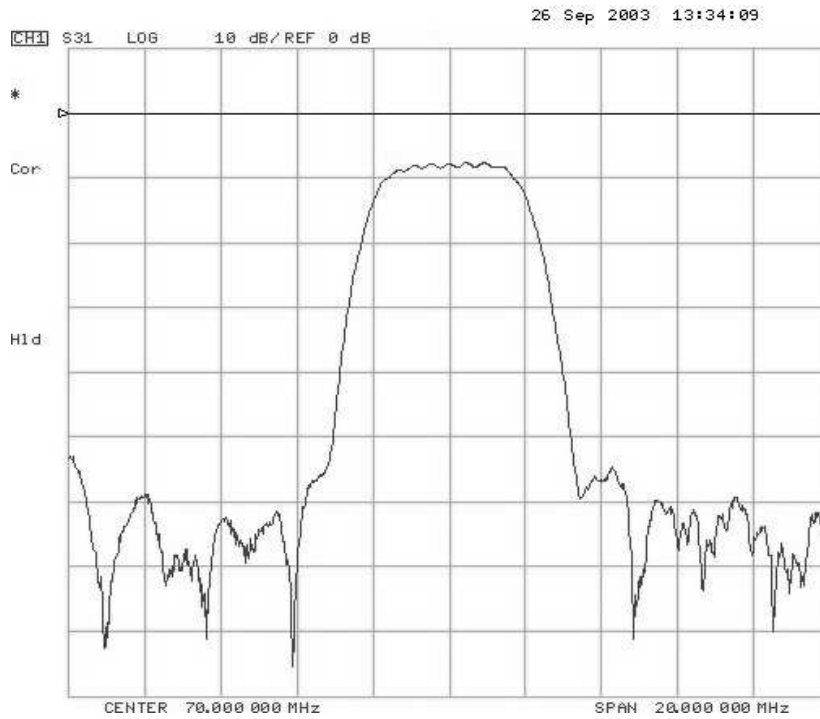

Filter Passband Amplitude and Group Delay Response

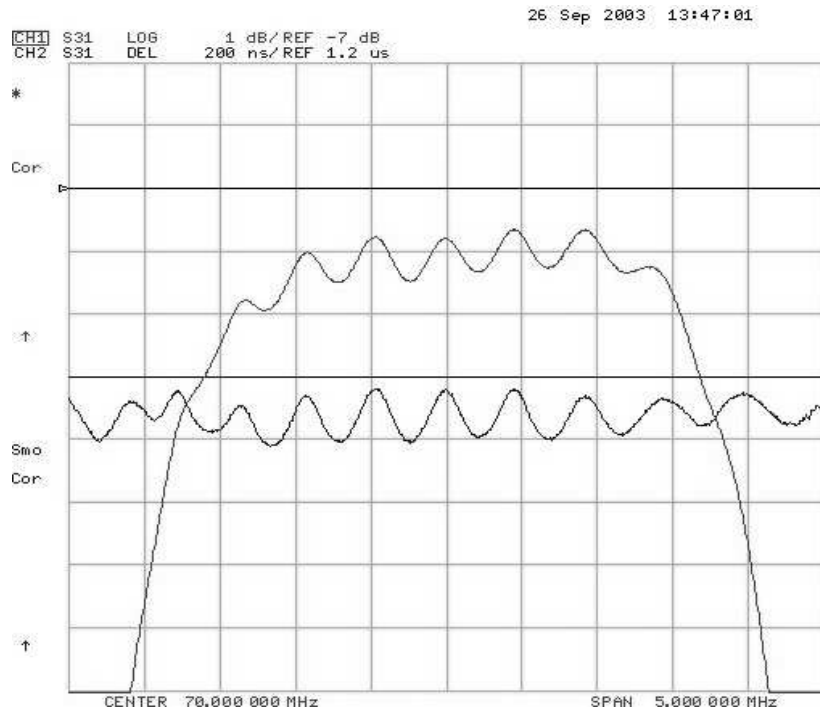

Ceramic Surface-mount 12-Terminal Case

Case Outline Drawing

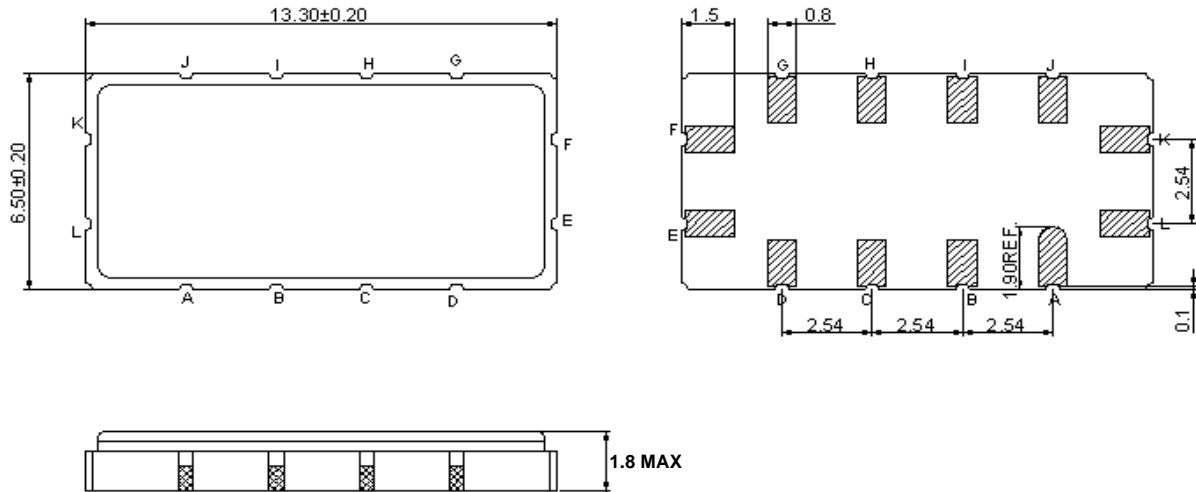

dimensions in mm

PCB Pad Layout

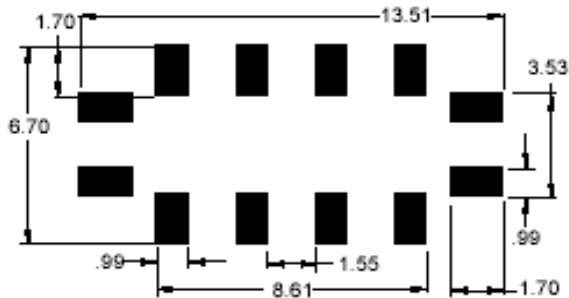

Case Material

Materials	
Solder Pad Plating	0.3 to 1.0 μm Gold over 1.27 to 8.89 μm Nickel
Lid Plating	2.0 to 3.0 μm Nickel
Body	Al_2O_3 Ceramic
Pb Free	

Electrical Connections

Connection	Terminals
Input	K
Output	E
Ground	All others

Tuning Network

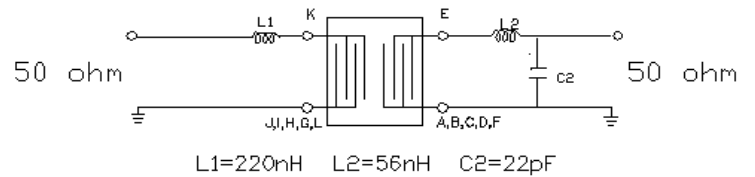

Tape and-Reel Details

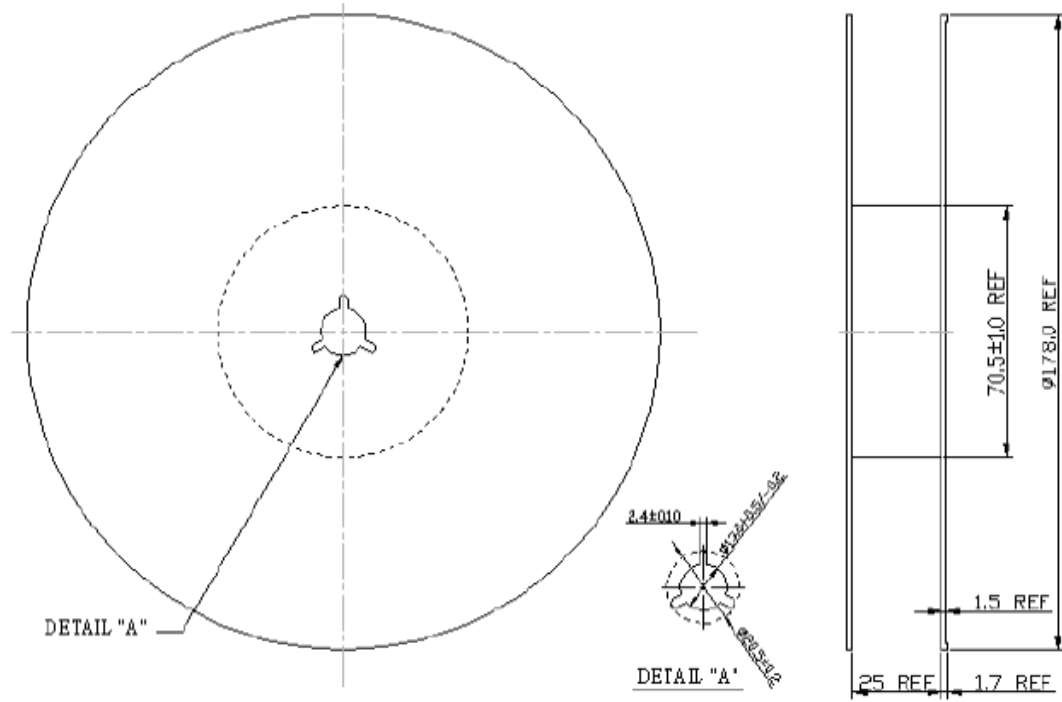

13.3X6.5

