

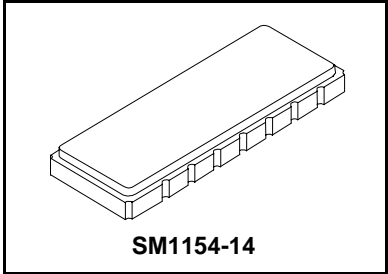

# Preliminary

**SF2221A**

**193.60 MHz  
SAW Filter**



- Precision IF SAW Filter
- Excellent Size-to-Performance Ratio
- Hermetic Surface-mount Case
- Single-ended Input and Output
- Complies with Directive 2002/95/EC (RoHS)



### Absolute Maximum Ratings

Rating	Value	Units
Maximum Incident Power in Passband	+18	dBm
Maximum DC Voltage Between any Two Terminals	30	VDC
Storage Temperature Range in Tape and Reel	-40 to +85	°C
Suitable for Lead-free Soldering - Maximum Soldering Profile	260°C for 30 s	

### Electrical Specifications

Characteristic	Sym	Notes	Min	Typ	Max	Units
Nominal Center Frequency	$f_c$		193.60			MHz
Passband:		1				
Minimum Insertion Loss, 192.9 to 194.3 MHz				8.0	9.0	dB
1 dB Bandwidth	$BW_1$	1, 2	1.0	1.27		MHz
3 dB Bandwidth	$BW_3$		1.4	1.82		MHz
3 dB Passband VSWR, Matched				2.2:1	3:1	
Group Delay Variation, 192.9 to 194.3 MHz	GDV			300	500	ns <sub>p-p</sub>
Absolute Delay at 193.6 MHz	AGD			800	900	1000
Rejection:		1, 2, 3				
191.8 and 195.4 MHz			25	30		dB
Ultimate Rejection, <182.6 MHz, >204.6 MHz			45	50		
Operating Temperature Range	$T_A$	1	0		+70	°C
Impedance Matching to 50 $\Omega$ Single-ended Source and Load	External L-C					
Case Style	SM1154-14, 11.5 x 4 mm Nominal Footprint					
Lid Symbolization (YY = year, WW = week)	SF2221A, YYWW					



**CAUTION: Electrostatic Sensitive Device. Observe precautions for handling.**

#### Notes:

1. Unless noted otherwise, all specifications apply over the operating temperature range with filter soldered to the specified demonstration board with impedance matching to 50  $\Omega$  and measured with 50  $\Omega$  network analyzer.
2. Unless noted otherwise, all frequency specifications are referenced to the nominal center frequency,  $f_c$ .
3. Rejection is measured as attenuation below the minimum IL point in the passband. Rejection in final user application is dependent on PCB layout and external impedance matching design. See Application Note No. 42 for details.
4. The turnover temperature,  $T_O$ , is the temperature of maximum (or turnover) frequency,  $f_o$ . The nominal frequency at any case temperature,  $T_C$ , may be calculated from:  $f=f_o[1-FTC(T_O-T_C)^2]$ .
5. The design, manufacturing process, and specifications of this filter are subject to change.
6. Either Port 1 or Port 2 may be used for either input or output in the design. However, impedances and impedance matching may vary between Port 1 and Port 2, so that the filter must always be installed in one direction per the circuit design.
7. US and international patents may apply.

# Frequency Response Plots

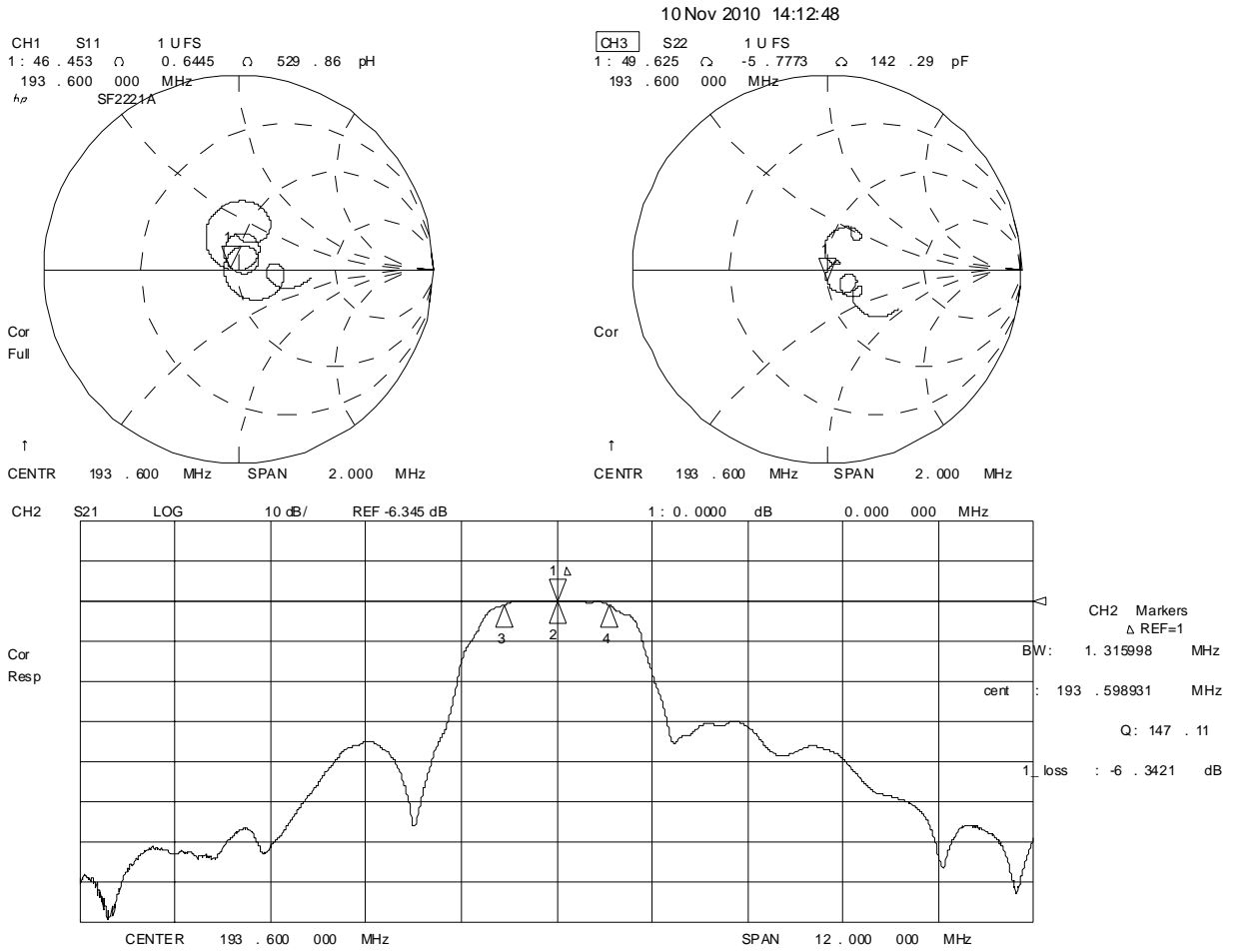

# Tuning Network Topology

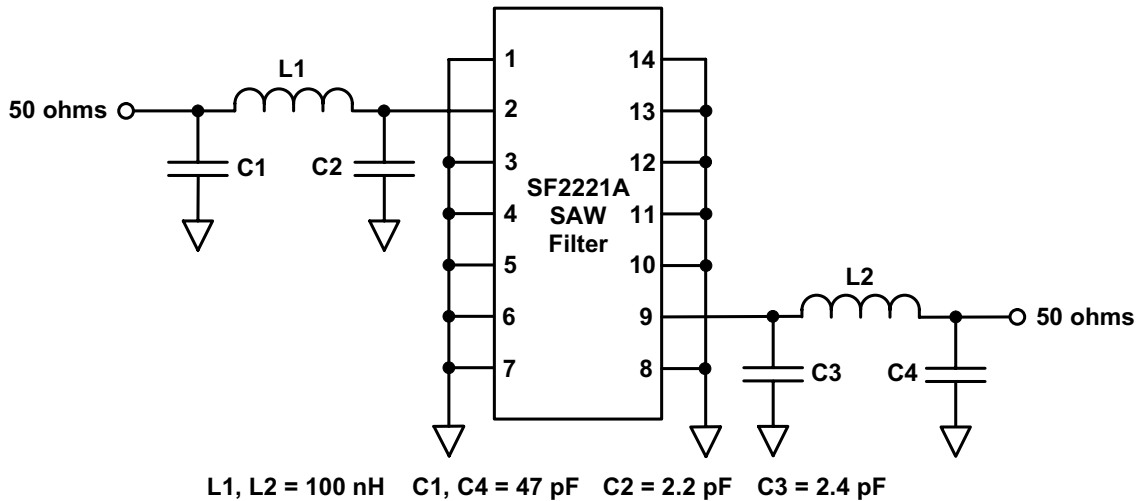

# SM1154-14 Ceramic Surface-mount 14-Terminal Case

## 11.5 x 4.0 mm Nominal Footprint

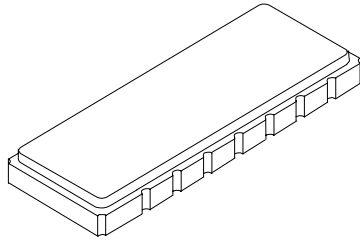

Case Dimensions						
Dimension	mm			Inches		
	Min	Nom	Max	Min	Nom	Max
A	11.4	11.5	11.6	.442	0.450	0.458
B	3.8	4.0	4.2	.150	0.157	.166
C	1.4	1.6	1.8	.057	0.063	.069
D	1.3	1.5	1.7	.053	0.059	.065
E		0.76			0.030	
F		1.27			0.050	
G		1.27			0.050	
H		0.1			0.004	

Materials	
Solder Pad Plating	0.3 to 1.0 $\mu\text{m}$ Gold over 1.27 to 8.89 $\mu\text{m}$ Nickel
Lid Plating	2.0 to 3.0 $\mu\text{m}$ Nickel
Body	$\text{Al}_2\text{O}_3$ Ceramic
	Pb Free

Electrical Connections	
Connection	Terminals
Input	2
Input Return	13
Output	9
Output Return	6
Ground	All Others

### Recommended PCB Footprint

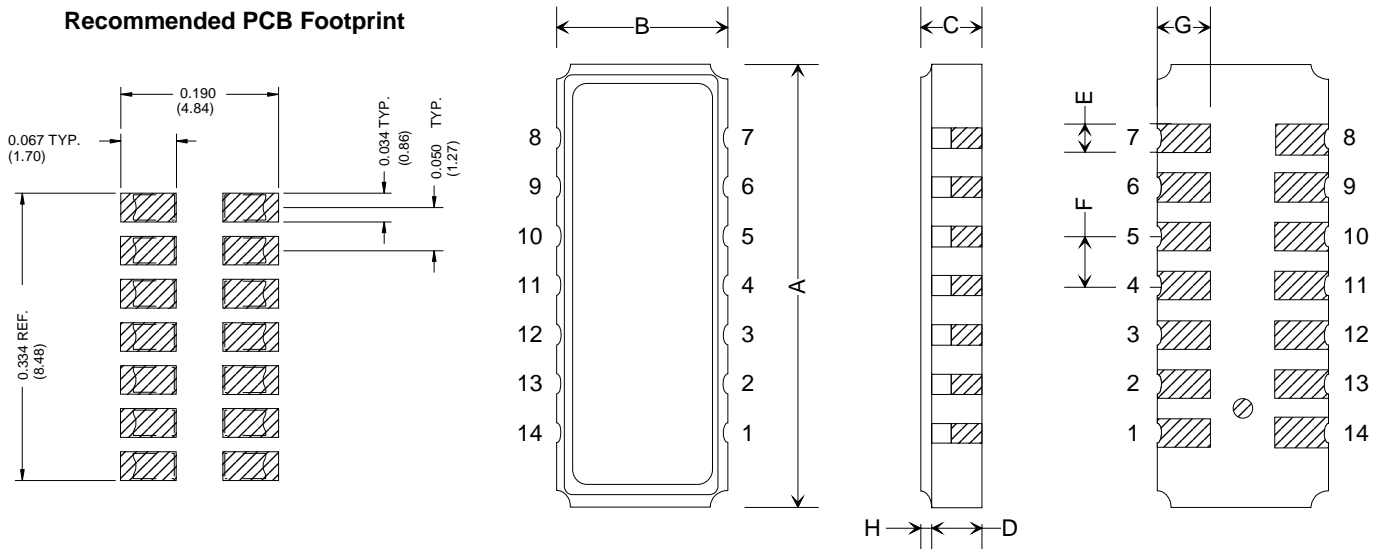

## COMPONENT ORIENTATION and DIMENSIONS

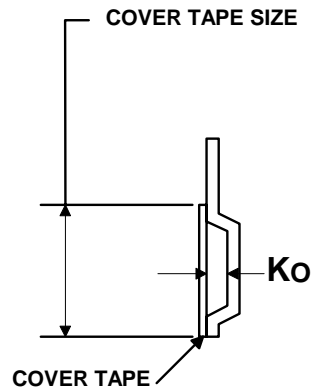
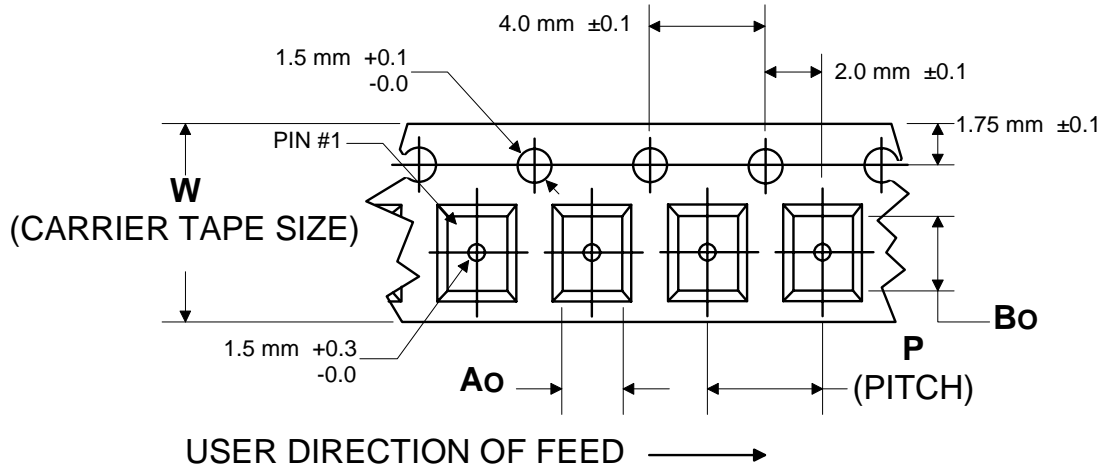

Carrier Tape Dimensions		
$A_o$	4.55 mm	$\pm 0.1$
$B_o$	12.04 mm	$\pm 0.1$
$K_o$	2.13 mm	$\pm 0.1$
Pitch	8.00 mm	$\pm 0.1$
$W$	24.00 mm	$\pm 0.3$