



- Ideal for 303.825 MHz Transmitters
- Very Low Series Resistance
- Quartz Stability
- Surface-Mount, Ceramic Case with 21 mm² Footprint
- Complies with Directive 2002/95/EC (RoHS)



RO3104E

**303.825 MHz
SAW
Resonator**

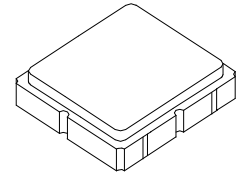

**SM3030-6 Case
3.0 X 3.0**

The RO3104E is a true one-port, surface-acoustic-wave (SAW) resonator in a surface-mount, ceramic case. It provides reliable, fundamental-mode, quartz frequency stabilization of fixed-frequency transmitters operating at 303.825 MHz. This SAW is designed specifically for AM transmitters in wireless security and remote control applications operating in the USA under FCC Part 15, in Australia, in Japan, and in Korea.

Absolute Maximum Ratings

Rating	Value	Units
CW RF Power Dissipation (See Typical Test Circuit)	0	dBm
DC Voltage Between Terminals (Observe ESD Precautions)	12	VDC
Case Temperature	-40 to +85	°C
Soldering Temperature	+260	°C

Electrical Characteristics

Characteristic		Sym	Notes	Minimum	Typical	Maximum	Units
Frequency (+25 °C)	Nominal Frequency	f _C	2, 3, 4, 5	303.750		303.900	MHz
	Tolerance from 303.825 MHz	Δf _C				±75	kHz
Insertion Loss		IL	2, 5, 6		1.35	2.0	dB
Quality Factor	Unloaded Q	Q _U	5, 6, 7		10000		
	50 Ω Loaded Q	Q _L			1400		
Temperature Stability	Turnover Temperature	T _O	6, 7, 8	10	25	40	°C
	Turnover Frequency	f _O			f _C		
	Frequency Temperature Coefficient	FTC			0.032		
Frequency Aging	Absolute Value during the First Year	f _A	1, 6		10		ppm/yr
DC Insulation Resistance between Any Two Terminals			5	1.0			MΩ
RF Equivalent RLC Model	Motional Resistance	R _M	5, 6, 7, 9		16		Ω
	Motional Inductance	L _M			85		μH
	Motional Capacitance	C _M			3.2		fF
	Transducer Static Capacitance	C _O		5, 6, 9	3.2		pF
Test Fixture Shunt Inductance		L _{TEST}	2, 7		85		nH
Lid Symbolization				690 // YWWS			
Standard Reel Quantity	Reel Size 7 Inch		10	500 Pieces/Reel			
	Reel Size 13 Inch			3000 Pieces/Reel			

CAUTION: Electrostatic Sensitive Device. Observe precautions for handling.

Notes:

- Frequency aging is the change in f_C with time and is specified at +65°C or less. Aging may exceed the specification for prolonged temperatures above +65°C. Typically, aging is greatest the first year after manufacture, decreasing in subsequent years.
- The center frequency, f_C, is measured at the minimum insertion loss point, IL_{MIN}, with the resonator in the 50 Ω test system (VSWR ≤ 1.2:1). The shunt inductance, L_{TEST}, is tuned for parallel resonance with C_O at f_C. Typically, f_OOSCILLATOR or f_OTRANSMITTER is approximately equal to the resonator f_C.
- One or more of the following United States patents apply: 4,454,488 and 4,616,197.
- Typically, equipment utilizing this device requires emissions testing and government approval, which is the responsibility of the equipment manufacturer.
- Unless noted otherwise, case temperature T_C = +25°C±2°C.
- The design, manufacturing process, and specifications of this device are subject to change.
- Derived mathematically from one or more of the following directly measured parameters: f_C, IL, 3 dB bandwidth, f_C versus T_C, and C_O.
- Turnover temperature, T_O, is the temperature of maximum (or turnover) frequency, f_O. The nominal frequency at any case temperature, T_C, may be calculated from: $f = f_O [1 - FTC (T_O - T_C)^2]$. Typically oscillator T_O is approximately equal to the specified resonator T_O.
- This equivalent RLC model approximates resonator performance near the resonant frequency and is provided for reference only. The capacitance C_O is the static (nonmotional) capacitance between the two terminals measured at low frequency (10 MHz) with a capacitance meter. The measurement includes parasitic capacitance with "NC" pads unconnected. Case parasitic capacitance is approximately 0.05 pF. Transducer parallel capacitance can be calculated as: $C_P \approx C_O - 0.05 \text{ pF}$.
- Tape and Reel Standard Per ANSI / EIA 481.

Electrical Connections

The SAW resonator is bidirectional and may be installed with either orientation. The two terminals are interchangeable and unnumbered. The callout NC indicates no internal connection. The NC pads assist with mechanical positioning and stability. External grounding of the NC pads is recommended to help reduce parasitic capacitance in the circuit.

Pin	Connection
1	NC
2	Terminal
3	NC
4	NC
5	Terminal
6	NC

Power Test

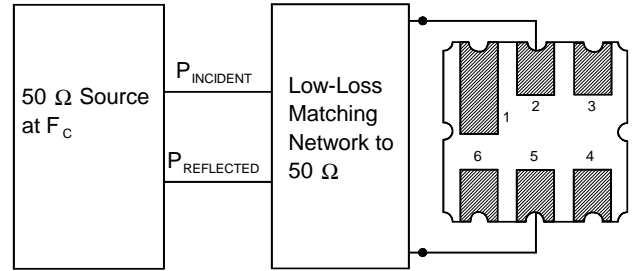

Typical Application Circuits

Typical Low-Power Transmitter Application

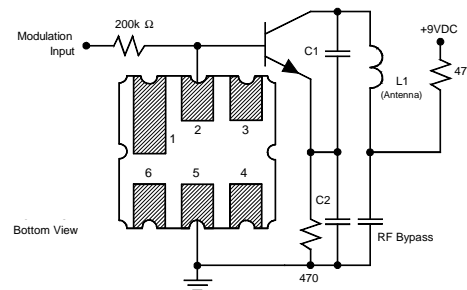

Typical Local Oscillator Application

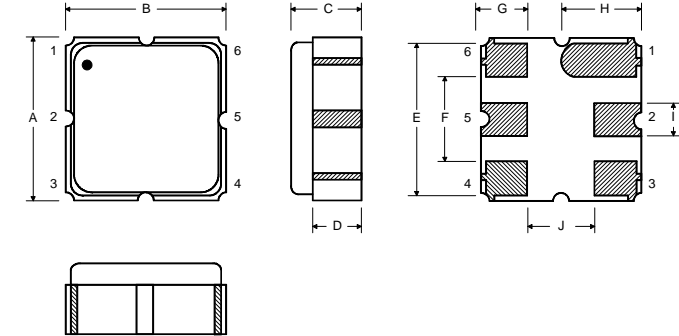
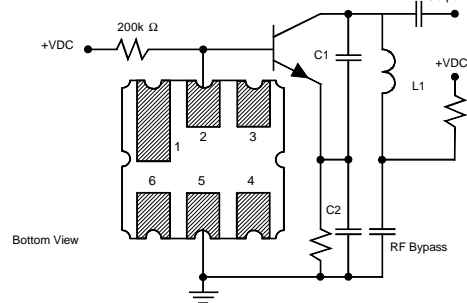

Case Dimensions

Dimension	mm			Inches		
	Min	Nom	Max	Min	Nom	Max
A	2.87	3.0	3.13	0.113	0.118	0.123
B	2.87	3.0	3.13	0.113	0.118	0.123
C	1.12	1.25	1.38	0.044	0.049	0.054
D	0.77	0.90	1.03	0.030	0.035	0.040
E	2.67	2.80	2.93	0.105	0.110	0.115
F	1.47	1.6	1.73	0.058	0.063	0.068
G	0.72	0.85	0.98	0.028	0.033	0.038
H	1.37	1.5	1.63	0.054	0.059	0.064
I	0.47	0.60	0.73	0.019	0.024	0.029
J	1.17	1.30	1.43	0.046	0.051	0.056

Typical Test Circuit

The test circuit inductor, L_{TEST} , is tuned to resonate with the static capacitance, C_O , at F_C .

Electrical Test

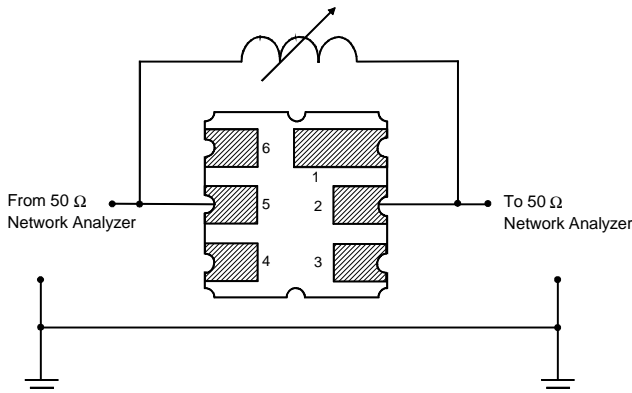

Equivalent LC Model

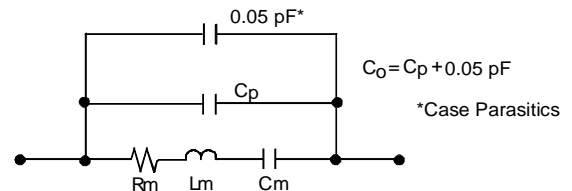

Temperature Characteristics

The curve shown on the right accounts for resonator contribution only and does not include LC component temperature contributions.

