

EW-732

Shipped in bulk(500pcs/Bag)

EW-732 is composed of a Ultra-high sensitive InSb Hall element and a signal processing IC chip in a package.

Bipolar Hall Effect Latch	Supply Voltage 2.2~18V	Hall Element Continuous Excitation	High Sensitivity $B_{op}:3mT$	Output With Pull-up Resistor	SIP
---------------------------	------------------------	------------------------------------	-------------------------------	------------------------------	-----

Notice:It is requested to read and accept "IMPORTANT NOTICE" written on the back of the front cover of this catalogue.

●Operational Characteristics

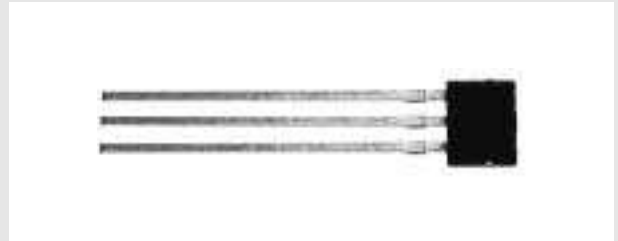
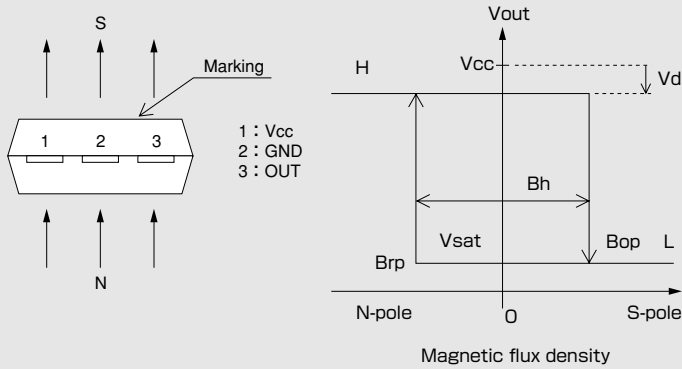

●Absolute Maximum Ratings (Ta=25°C)

Item	Symbol	Limit	Unit
Supply Voltage	V _{CC}	18 ^(*)	V
Output H Voltage	V _{O(off)}	V _{CC}	V
Output L Current	I _{sink}	12	mA
Operating Temperature Range	Topr	-30 ~ 115	°C
Storage Temperature Range	Tstg	-40 ~ 125	°C

(*) Please refer to Supply Voltage Derating Curve.

●Functional Block Diagram

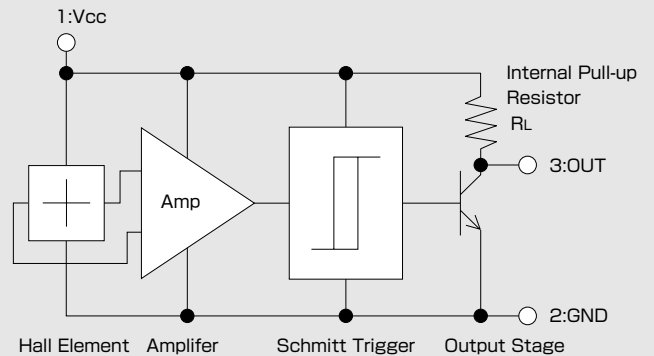

●Magnetic and Electrical Characteristics (Ta=25°C)

Item	Symbol	Conditions	Min.	Typ.	Max.	Unit
Supply Voltage	V _{CC}		2.2	12	18	V
Operating Point	B _{OP}	V _{CC} =12V		3	6	mT
Release Point	B _{rp}	V _{CC} =12V	-6	-3		mT
Hysteresis	B _h	V _{CC} =12V		6		mT
Output Saturation Voltage	V _{sat}	V _{CC} =12V,OUT"L"			0.4	V
Supply Current	I _{CC}	V _{CC} =12V,OUT"H"			8	mA
Output Down Voltage	V _d	V _{CC} =12V,OUT"H"			20	mV
Internal Load Resistance	R _L		6		14	kΩ

1 [mT]=10 [Gauss]

•Please be aware that our products are not intended for use in life support equipment, devices, or systems. Use of our products in such applications requires the advance written approval of our sales staff.
 Certain applications using semiconductor devices may involve potential risks of personal injury, property damage, or loss of life. In order to minimize these risks, adequate design and operating safeguards should be provided by the customer to minimize inherent or procedural hazards. Inclusion of our products in such applications is understood to be fully at the risk of the customer using our devices or systems.

●Package (Unit:mm)

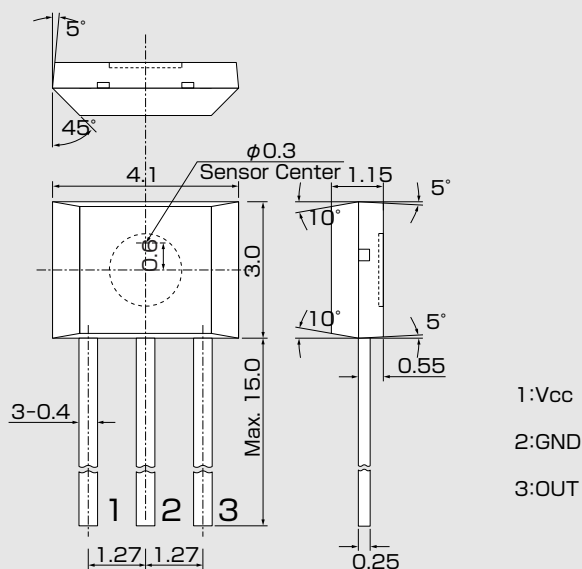

Note) The sensor center is located within the $\phi 0.3$ mm circle.

●Supply Voltage

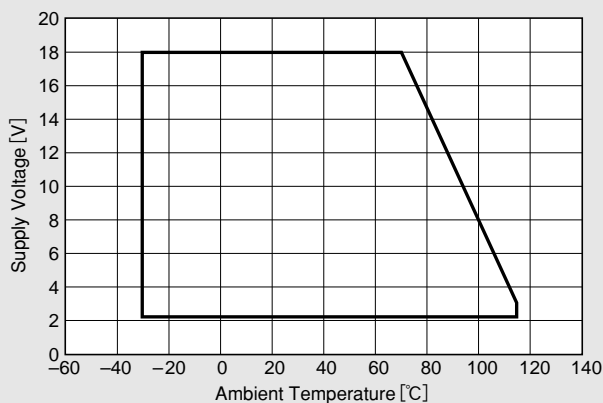

●Temperature Dependence of Bop, Brp

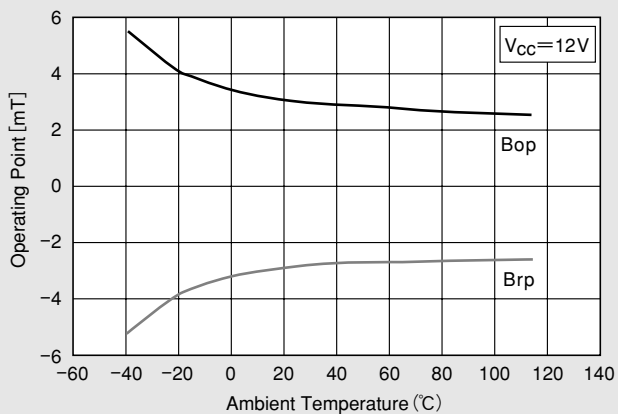

●Supply Voltage Dependence of Bop, Brp

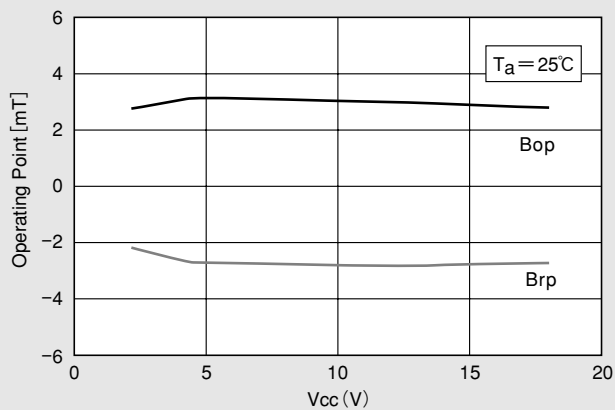

IMPORTANT NOTICE

- These products and their specifications are subject to change without notice. When you consider any use or application of these products, please make inquiries the sales office of Asahi Kasei Microdevices Corporation (AKM) or authorized distributors as to current status of the products.
- Descriptions of external circuits, application circuits, software and other related information contained in this document are provided only to illustrate the operation and application examples of the semiconductor products. You are fully responsible for the incorporation of these external circuits, application circuits, software and other related information in the design of your equipments. AKM assumes no responsibility for any losses incurred by you or third parties arising from the use of these information herein. AKM assumes no liability for infringement of any patent, intellectual property, or other rights in the application or use of such information contained herein.
- Any export of these products, or devices or systems containing them, may require an export license or other official approval under the law and regulations of the country of export pertaining to customs and tariffs, currency exchange, or strategic materials.
- AKM products are neither intended nor authorized for use as critical components^{Note1)} in any safety, life support, or other hazard related device or system^{Note2)}, and AKM assumes no responsibility for such use, except for the use approved with the express written consent by Representative Director of AKM. As used here:
 - Note1) A critical component is one whose failure to function or perform may reasonably be expected to result, whether directly or indirectly, in the loss of the safety or effectiveness of the device or system containing it, and which must therefore meet very high standards of performance and reliability.
 - Note2) A hazard related device or system is one designed or intended for life support or maintenance of safety or for applications in medicine, aerospace, nuclear energy, or other fields, in which its failure to function or perform may reasonably be expected to result in loss of life or in significant injury or damage to person or property.
- It is the responsibility of the buyer or distributor of AKM products, who distributes, disposes of, or otherwise places the product with a third party, to notify such third party in advance of the above content and conditions, and the buyer or distributor agrees to assume any and all responsibility and liability for and hold AKM harmless from any and all claims arising from the use of said product in the absence of such notification.

June 2, 2010