

HCP Series



- High Efficiency up to 91%
- High Power Density
- Programmable Output Voltage (30%–105%)
- Programmable Output Current (40%–105%)
- Parallel Operation
- Fully Featured Signals & Controls
- 3 Year Warranty

Specification

Input

Input Voltage	• 90-264 VAC (127-370 VDC), see derating curves
Input Frequency	• 47-63 Hz
Input Current	• 650 W: 7.5 A/3.5 A typical, 1000 W: 12 A/5 A typical, 1500 W: 18 A/9 A typical, 3000 W: 36 A/18 A typical at 115/230 VAC
Inrush Current	• 650/1000 W: 27 A/54 A typical 1500 W: 30 A/45 A typical 3000 W: 60 A/90 A typical at 115/230 VAC
Power Factor	• 0.99/0.98, typical at 115/230 VAC full load
Earth Leakage Current	• <1.0 mA (3 kW: <2.5 mA) at 240VAC/60 Hz

Output

Output Voltage	• See model table
Output Trim	• $\pm 5.0\%$ by potentiometer
Output Voltage Program	• 30-105% of rated output (see app. notes)
Output Current Program	• 40-105% of rated output (see app. notes)
Initial Set Accuracy	• $\pm 1\%$
Minimum Load	• No minimum load required
Start Up Delay	• 650 W/1000 W: 800 ms max. 1500 W/3000 W: 1 s max.
Start Up Rise Time	• 650 W: 90 ms max. at full load 1000 W: 100 ms max. at full load 1500 W/3000 W: 350 ms max. at full load
Hold Up Time	• 16 ms (3000 W: 20 ms) typ. at 230 VAC and full load
Line Regulation	• $\pm 0.5\%$
Load Regulation	• V1: $\pm 0.5\%$, 5 V standby output: $\pm 3\%$
Transient Response	• <1% for a 25% step load change
Ripple & Noise	• 150 mV pk-pk all voltages (see note 1)
Overvoltage Protection	• Tracks output voltage. 115-135% of set voltage. Recycle AC to reset
Overtemperature Protection	• Auto recovery
Overload Protection	• 105-125% of output power. Constant power to 75% of set output voltage then output shuts down, recycle AC to reset
Short Circuit Protection	• Output latches off, recycle AC to reset
Temp. Coefficient	• $\pm 0.02\%/^{\circ}\text{C}$ (0-50 $^{\circ}\text{C}$)
Remote Sense	• Compensates for 0.5 V max voltage drop. (see app. notes)
Enable	• Output must be enabled (see app. notes)
Current Share	• 5 supplies can share within 5%
Standby Output	• See model table

General

Efficiency	• See model table
Isolation	• 3000 VAC Input to Output, 1500 VAC Input to Ground, 500 VDC Output to Ground
Isolation Resistance	• 100 M Ω /500 VDC
Switching Frequency	• PFC 100 kHz typical, PWM 65 kHz typical
Power Density	• 650 W: 8.2 W/in ³ 1000 W: 11.1 W/in ³ 1500 W/3000 W: 10.8 W/in ³
Signals & Controls	• See app. notes
MTBF	• 650 W: 160 kHrs, 1000 W: 140 kHrs, 1500 W/3000 W: 100 kHrs to MIL-HDBK-217F at 25 $^{\circ}\text{C}$, GB

Environmental

Operating Temperature	• -25 $^{\circ}\text{C}$ to 60 $^{\circ}\text{C}$, see derating curves
Cooling	• Internal fan fitted. Speed increases with load and internal temperature
Operating Humidity	• 20-90% R.H. non-condensing
Storage Temperature	• -40 $^{\circ}\text{C}$ to +85 $^{\circ}\text{C}$
Storage Humidity	• 10-95% R.H.
Vibration	• 10-500 Hz, 5 g 10 min/cycle, 60 min period for each axis. Compliant to IEC68-2-16, IEC 68-2-64

EMC & Safety

Emissions	• EN55022 class B conducted & radiated
Harmonic Currents	• EN61000-3-2 class A, 650 & 1000 W: EN61000-3-2 class C for loads $\geq 10\%$, 1500 W: EN61000-3-2 class C for loads $\geq 40\%$, 3000 W: EN61000-3-2 class C for loads $\geq 30\%$
Voltage Flicker	• EN61000-3-3
ESD Immunity	• EN61000-4-2, ± 4 kV contact, ± 8 kV air discharge, Perf Criteria A
Radiated Immunity	• EN61000-4-3, 3 V/m, Perf Criteria A
EFT/Burst	• EN61000-4-4, level 2, Perf Criteria A
Surge	• EN61000-4-5, installation class 3, Perf Criteria A
Conducted Immunity	• EN61000-4-6, Perf Criteria A
Magnetic Field	• EN61000-4-8, Perf Criteria A
Dips & Interruptions	• EN61000-4-11, 30% 10 ms, 60% 100 ms, >95% 5000 ms, Perf Criteria A, B, B
Safety Approvals	• UL60950-1, EN60950-1 (all models) CSA C22.2 No. 60950-1 (650 W/1000 W only)

Models and Ratings

Output Power	Output Voltage V1	Output Current		Standby Output ⁽³⁾	Efficiency ⁽²⁾	Model Number
		Min	Max			
500 W	5.0 VDC	0.0 A	100.0 A	5 V/0.5 A	83%	HCP650PS05
600 W	12.0 VDC	0.0 A	50.0 A	5 V/0.5 A	88%	HCP650PS12
600 W	15.0 VDC	0.0 A	40.0 A	5 V/0.5 A	88%	HCP650PS15
650 W	24.0 VDC	0.0 A	27.0 A	5 V/0.5 A	90%	HCP650PS24
650 W	27.0 VDC	0.0 A	24.0 A	5 V/0.5 A	90%	HCP650PS27
650 W	48.0 VDC	0.0 A	13.6 A	5 V/0.5 A	91%	HCP650PS48

Notes

1. Ripple & noise is measured with 20 MHz bandwidth and using 12" twisted pair-wire terminated with 0.1 μF & 47 μF capacitors in parallel.
2. Measured with 230 VAC input and full load.
3. Present whenever AC is applied.

Mechanical Details

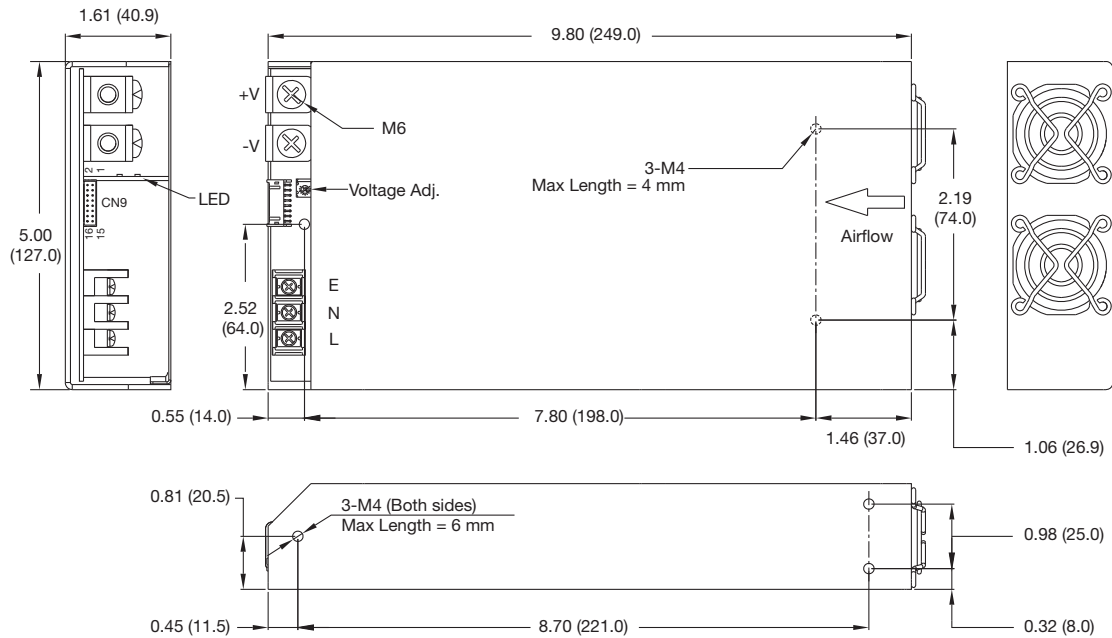

Control Pin Connections						
Pin	Function	Description	Pin	Function	Description	
1	VS+	Remote Sense (+)	9	EN-	Enable ON/OFF (-)	
2	VO+	Local Sense (+)	10	GND	Signal Ground	
3	VS-	Remote Sense (-)	11	PWM (P-OK)	PWM is Switching	
4	VO-	Local Sense (-)	12	GND	Signal Ground	
5	5 V SB (Aux)	5 V Standby Output (+)	13	VCI	V Program	
6	5 V SB (Aux)	5 V Standby Output (+)	14	GND	Signal Ground	
7	EN+	Enable ON/OFF (+)	15	CS	Current Share	
8	GND	Signal Ground	16	ACI	I Program	

Notes

1. All dimensions are in inches (mm).
2. Weight 3.85 lb (1.75 kg)
3. Signals mating connector: PHDR-16VS housing, SPHD-002T-P05 contacts

Derating Curve

Thermal Derating Curve

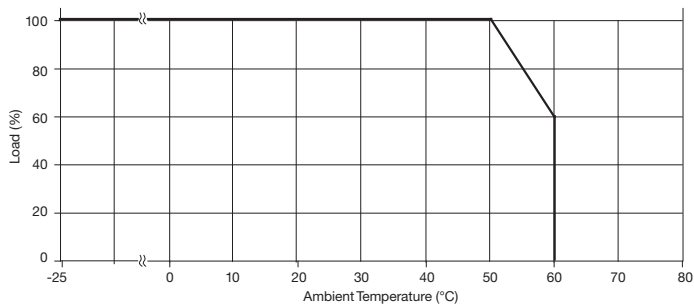

Input Derating Curve

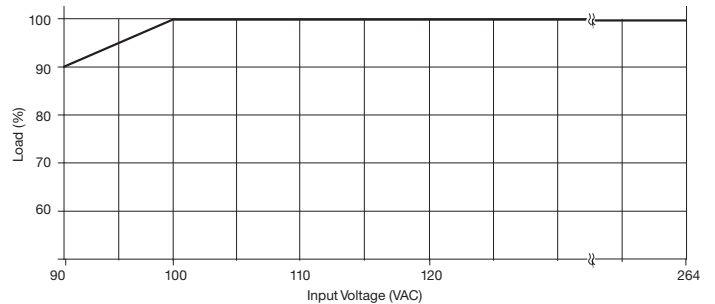

Models and Ratings

Output Power	Output Voltage V1	Output Current		Standby Output ⁽³⁾	Efficiency ⁽²⁾	Model Number
		Min	Max			
750 W	12.0 VDC	0.0 A	62.0 A	5 V/0.5 A	87%	HCP1000PS12
750 W	15.0 VDC	0.0 A	50.0 A	5 V/0.5 A	88%	HCP1000PS15
960 W	24.0 VDC	0.0 A	40.0 A	5 V/0.5 A	89%	HCP1000PS24
1000 W	27.0 VDC	0.0 A	37.0 A	5 V/0.5 A	89%	HCP1000PS27
1000 W	48.0 VDC	0.0 A	21.0 A	5 V/0.5 A	90%	HCP1000PS48

Notes

1. Ripple & noise are measured with 20 MHz bandwidth and using 12" twisted pair-wire terminated with 0.1 μF & 47 μF capacitors in parallel.
2. Measured with 230 VAC input and full load.
3. Present whenever AC is applied.

Mechanical Details

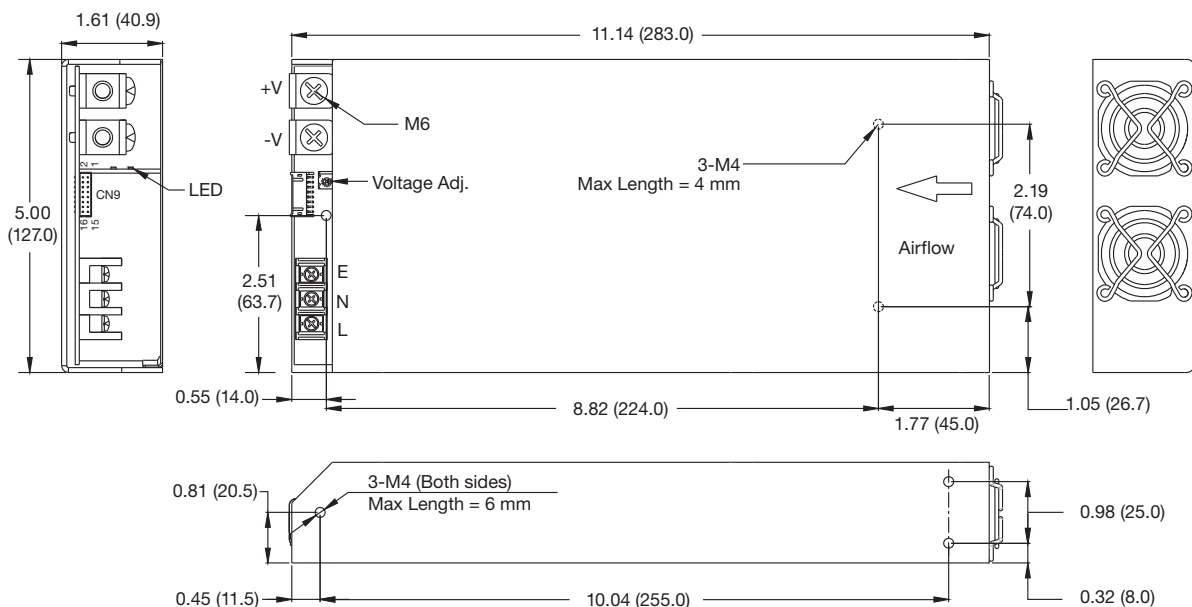

Control Pin Connections					
Pin	Function	Description	Pin	Function	Description
1	VS+	Remote Sense (+)	9	EN-	Enable ON/OFF (-)
2	VO+	Local Sense (+)	10	GND	Signal Ground
3	VS-	Remote Sense (-)	11	PWM (P-OK)	PWM is Switching
4	VO-	Local Sense (-)	12	GND	Signal Ground
5	5 V SB (Aux)	5 V Standby Output (+)	13	VCI	V Program
6	5 V SB (Aux)	5 V Standby Output (+)	14	GND	Signal Ground
7	EN+	Enable ON/OFF (+)	15	CS	Current Share
8	GND	Signal Ground	16	ACI	I Program

Notes

1. All dimensions are in inches (mm).
2. Weight 4.1 lb (1.9 kg)
3. Signals mating connector: PHDR-16VS housing, SPHD-002T-P05 contacts

Derating Curve

Thermal Derating Curve

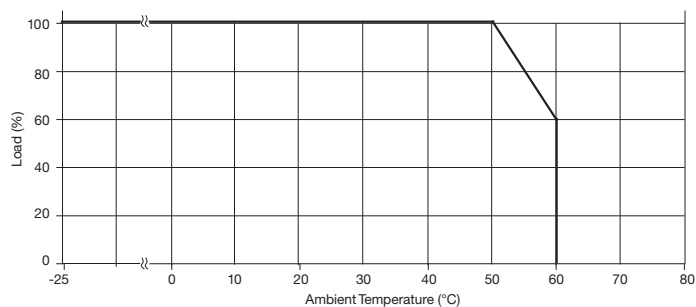

Input Derating Curve

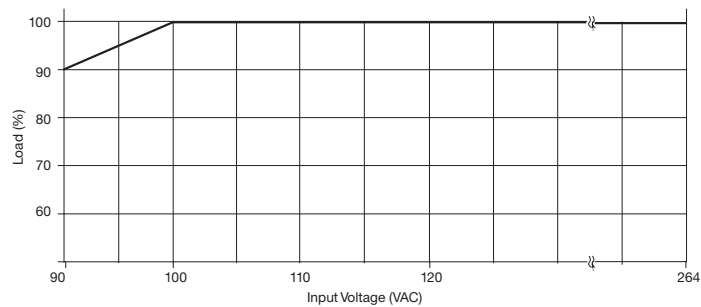

Models and Ratings

Output Power	Output Voltage V1	Output Current		Standby Output ⁽³⁾	Efficiency ⁽²⁾	Model Number
		Min	Max			
1500 W	12.0 VDC	0.0 A	125.0 A	5 V/0.5 A	87%	HCP1500PS12
1500 W	15.0 VDC	0.0 A	100.0 A	5 V/0.5 A	88%	HCP1500PS15
1500 W	24.0 VDC	0.0 A	62.5 A	5 V/0.5 A	89%	HCP1500PS24
1500 W	27.0 VDC	0.0 A	55.5 A	5 V/0.5 A	89%	HCP1500PS27
1500 W	48.0 VDC	0.0 A	31.3 A	5 V/0.5 A	90%	HCP1500PS48

Notes

1. Ripple & noise are measured with 20 MHz bandwidth and using 12" twisted pair-wire terminated with 0.1 μF & 47 μF capacitors in parallel.
2. Measured with 230 VAC input and full load.
3. Present whenever AC is applied.

Mechanical Details

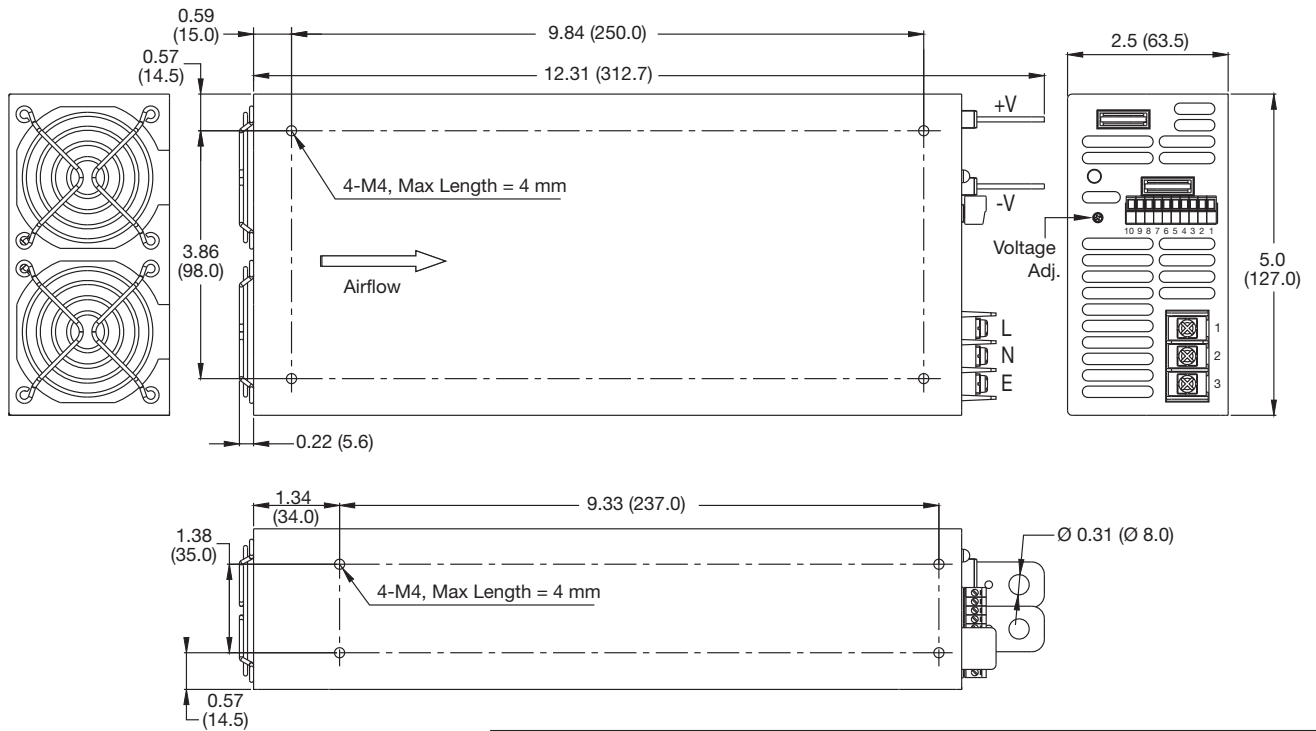

Control Pin Connections					
Pin	Function	Description	Pin	Function	Description
1	VS+	Remote Sense (+)	6	GND	Signal Ground
2	VS-	Remote Sense (-)	7	PWM (P-OK)	PWM is Switching
3	5 V SB (Aux)	5 V Standby Output (+)	8	VCI	V Program
4	EN+	Enable (+)	9	ACI	I Program
5	EN-	Enable (-)	10	CS	Current Share

Notes

1. All dimensions are in inches (mm).
2. Weight 4.1 lb (1.9 kg)
3. Signals mating connector is Dinkle EC350V-10P or equivalent. Wire gauge 28-14 AWG.

Thermal Derating Curve

For HCP1500PS12/15

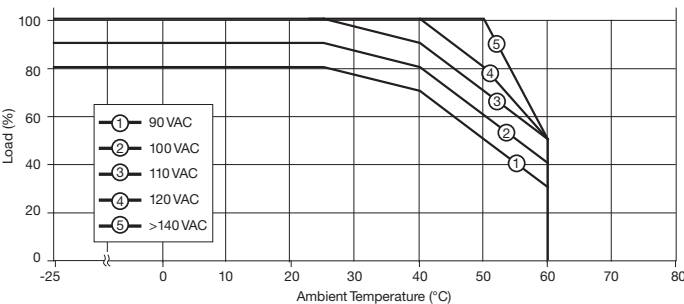

For HCP1500PS24/27/48

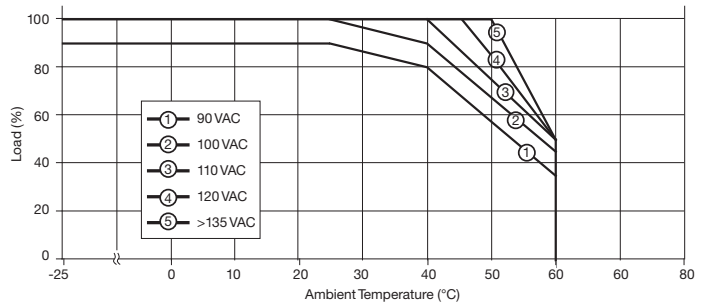

Models and Ratings

Output Power	Output Voltage V1	Output Current		Standby Output ⁽³⁾	Efficiency ⁽²⁾	Model Number
		Min	Max			
3000 W	12.0 VDC	0.0 A	250.0 A	5 V/0.5 A	87%	HCP3000PS12
3000 W	15.0 VDC	0.0 A	200.0 A	5 V/0.5 A	88%	HCP3000PS15
3000 W	24.0 VDC	0.0 A	125.0 A	5 V/0.5 A	89%	HCP3000PS24
3000 W	27.0 VDC	0.0 A	111.1 A	5 V/0.5 A	89%	HCP3000PS27
3000 W	48.0 VDC	0.0 A	62.5 A	5 V/0.5 A	90%	HCP3000PS48

Notes

1. Ripple & noise are measured with 20 MHz bandwidth and using 12" twisted pair-wire terminated with 0.1 μF & 47 μF capacitors in parallel.
2. Measured with 230 VAC input and full load.
3. Present whenever AC is applied.

Mechanical Details

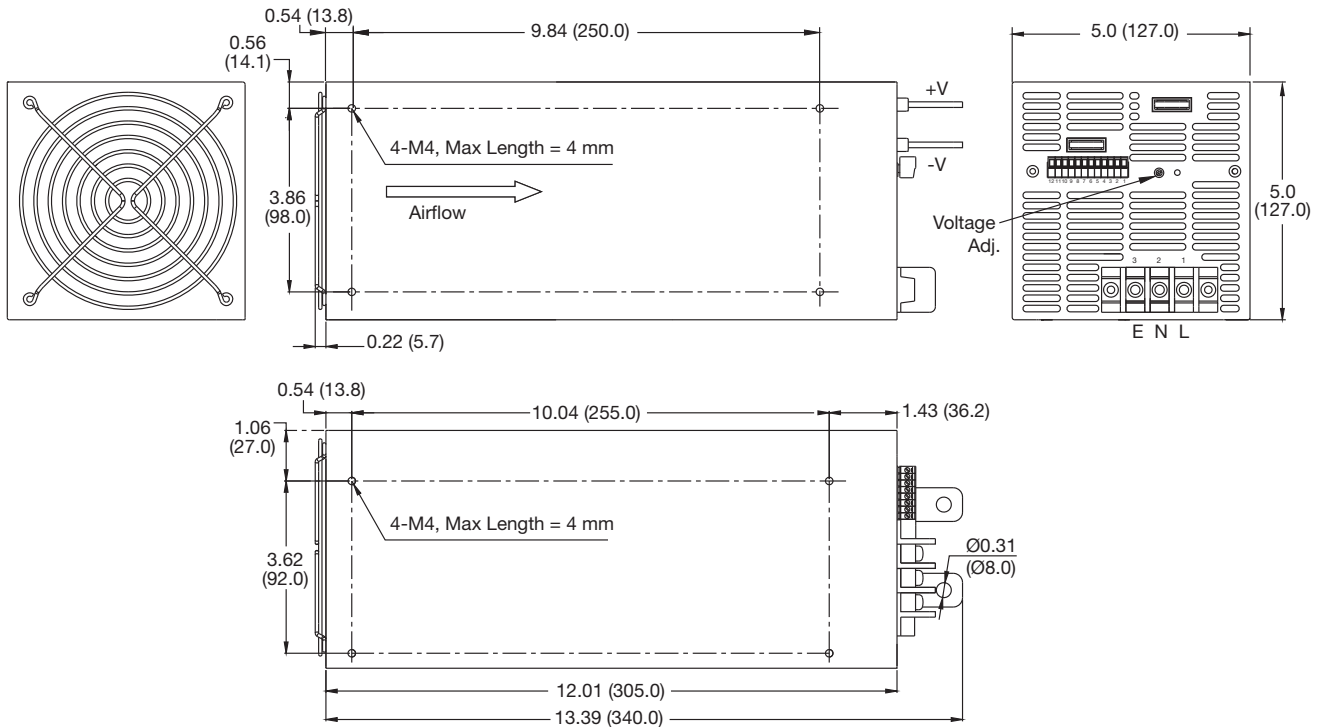

Notes

1. All dimensions are in inches (mm).
2. Weight 4.1 lb (1.9 kg)
3. Signals connector is Dinkle EC350V-12P or equivalent. Wire gauge 28-14 AWG.

Control Pin Connections						
Pin	Function	Description	Pin	Function	Description	
1	VO+	Local Sense (+)	7	EN-	Enable (-)	
2	VS+	Remote Sense (+)	8	GND	Signal Ground	
3	VS-	Remote Sense (-)	9	PWM (P-OK)	PWM is Switching	
4	VO-	Local Sense (-)	10	VCI	V Program	
5	5 V SB (AUX)	5 V Standby Output(+)	11	ACI	I Program	
6	EN+	Enable (+)	12	CS	Current Share	

Derating Curve

For HCP3000PS12/15

For HCP3000PS24/27/48

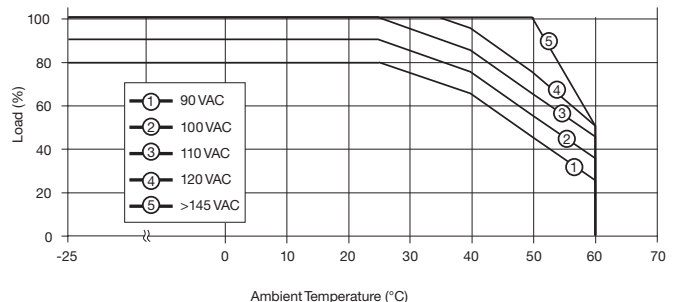
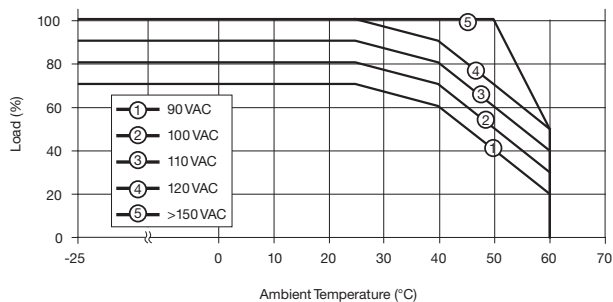

Remote Enable (unit supplied enabled)

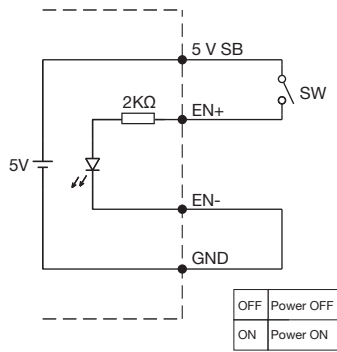

(A) Using internal 5 V standby

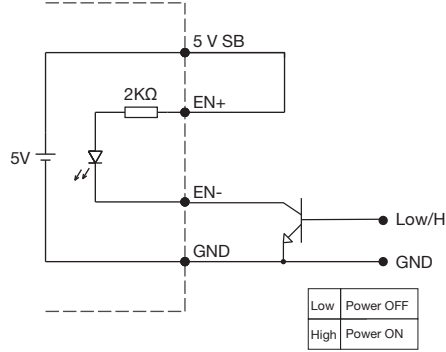

(B) Using external by transistor

PWM Signal

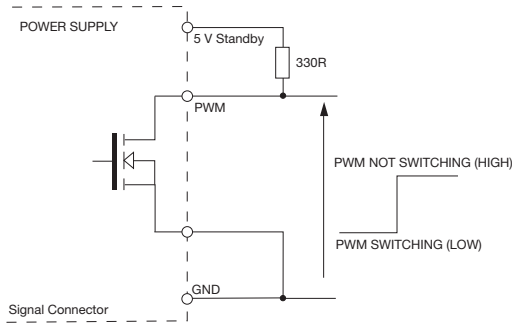

Remote Sense

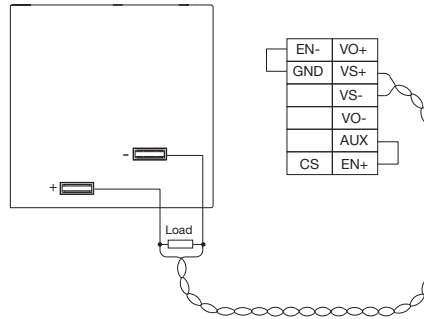

Local Sense

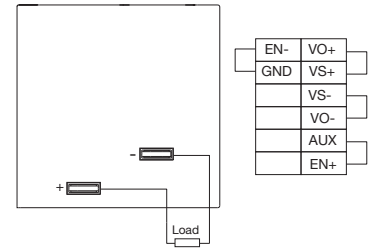

Must be used if remote sense is not required.

LED Status

LED Status	Output Status
Solid (Green)	DC Output OK
Slow Blink (Green)	Output Not Enabled
Fast Blink (Red)	Over Voltage
Solid (Red)	Over Loaded
	Short Circuited
	Under Voltage (<70% of output voltage)
Slow Blink (Red)	Over Temperature
Intermittent Blink (Red)	Fan Fail
Short & Long Blink (Red)	5 V Standby Failure

Output Voltage Program

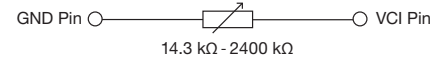
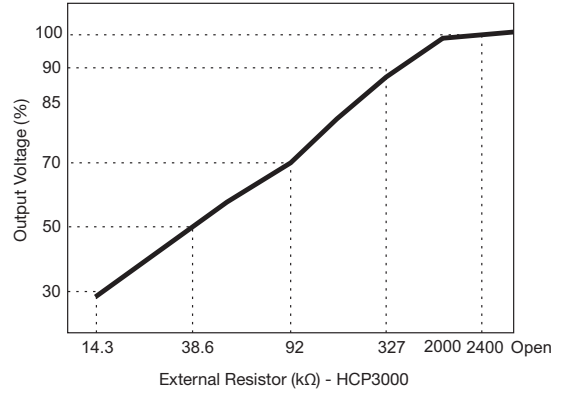
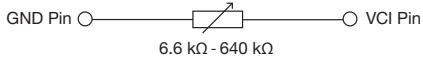
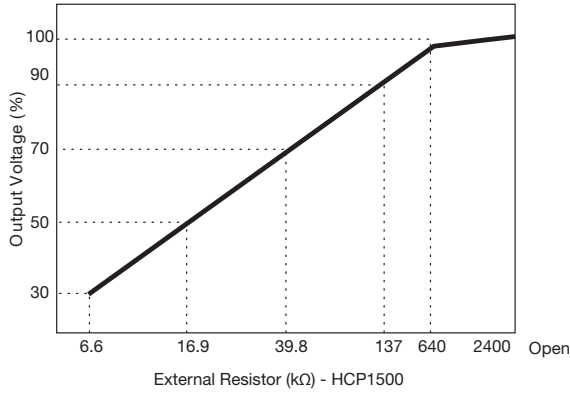
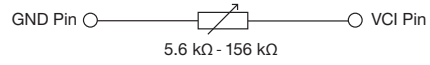
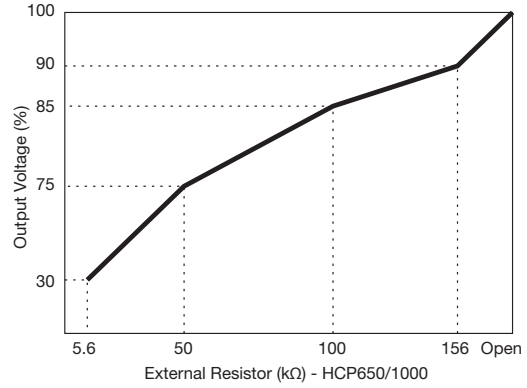
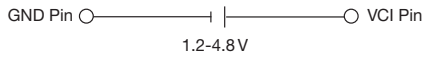
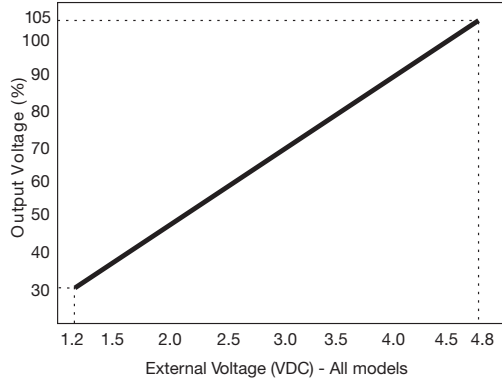

Output Current Program

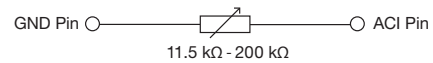
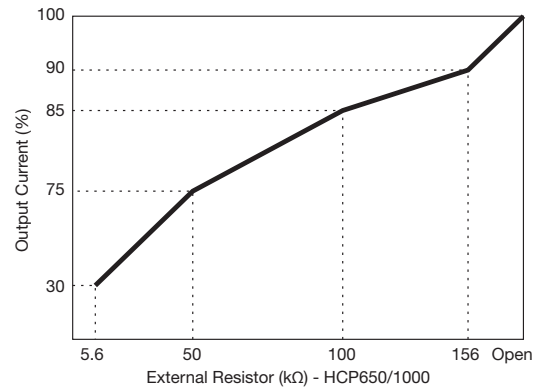
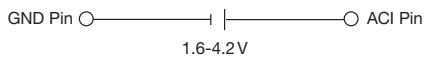
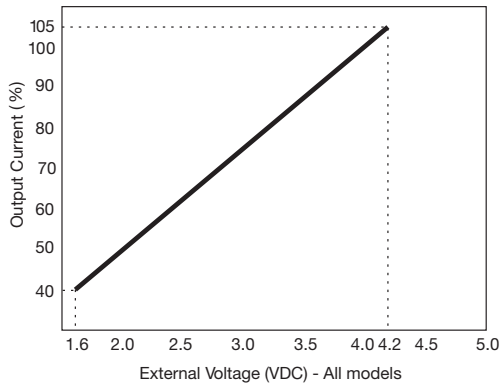

Output Current Program

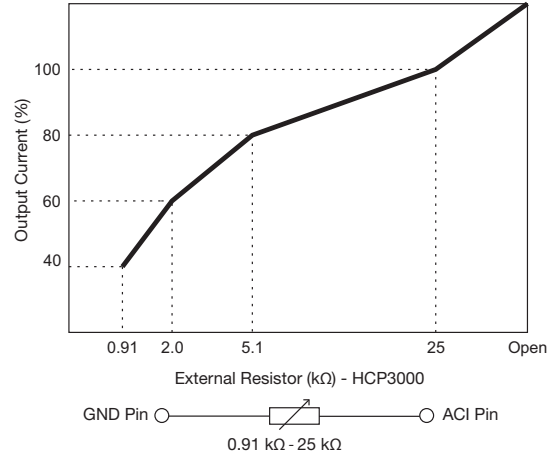
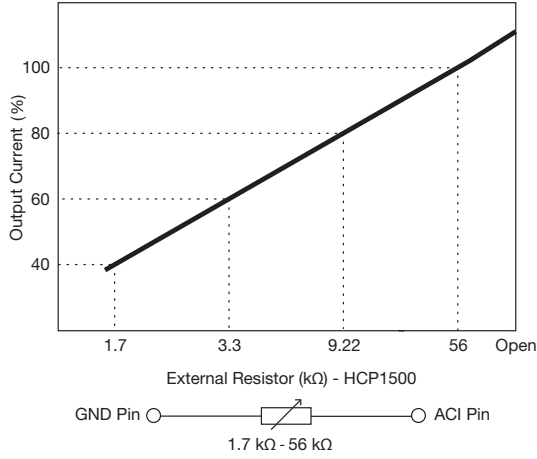

Current Sharing with Remote Sensing

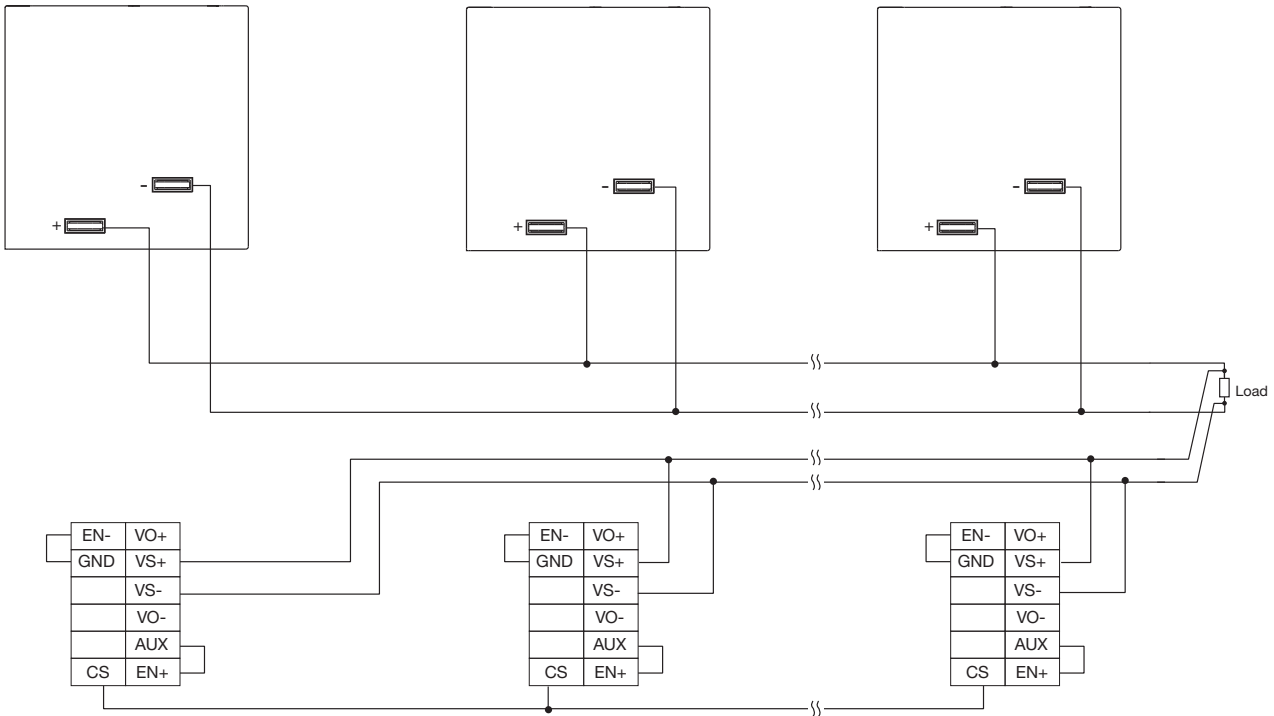

Current Sharing with Local Sensing

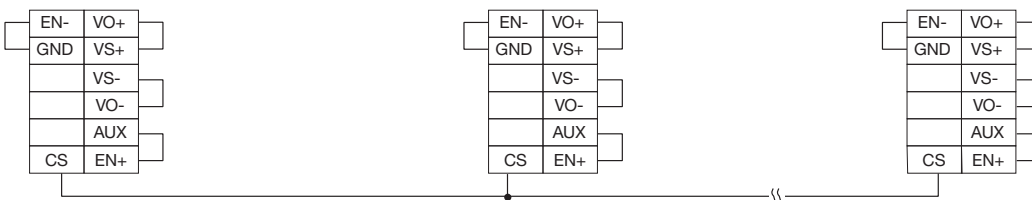

Notes

In parallel operation, it is possible that only one unit will operate if the load is less than 5% of the combined rated output load. It is possible to have more than five units in parallel, contact sales for details.