

**SPKC1645FL**

**SCHOTTKY BARRIER SOLAR RECTIFIER**

**VOLTAGE 45 Volts CURRENT 16 Amperes**

**FEATURES**

- \* Low switching noise
- \* Low forward voltage drop
- \* Low thermal resistance
- \* High current capability
- \* High surge capability
- \* High reliability
- \* Ideal for solar panel PV application such as Bypass diode

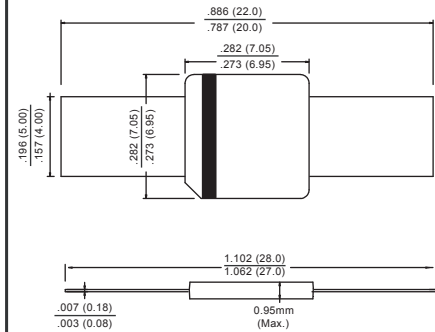
**MECHANICAL DATA**

- \* Case: ThinPAQ
- \* Epoxy: Device has UL flammability classification 94V-0
- \* Lead: MIL-STD-202B method 208C guaranteed
- \* Mounting position: Any

**MAXIMUM RATINGS AND ELECTRICAL CHARACTERISTICS**

Ratings at 25 °C ambient temperature unless otherwise specified.

**ThinPAQ**



Dimensions in inches and (millimeters)

**MAXIMUM RATINGS (@ TA=25 °C unless otherwise noted)**

RATINGS	SYMBOL	SPKC1645FL	UNITS
Maximum Recurrent Peak Reverse Voltage	$V_{RRM}$	45	Volts
Maximum RMS Voltage	$V_{RMS}$	31.5	Volts
Maximum DC Blocking Voltage	$V_{DC}$	45	Volts
Maximum DC Forward Current @ $T_L=125^{\circ}C$ (Note 1)	$I_o$	16	Amps
Peak Forward Surge Current 8.3 ms single half sine-wave superimposed on rated load (JEDEC method)	$I_{FSM}$	300	Amps
Typical Current Square Time	$I^2T$	373.3	A <sup>2</sup> S
Operating Temperature Range	$T_J$	175( $T_j \leq 200C$ in Bypass Mode)	°C
Storage Temperature Range	$T_{STG}$	-55 to + 175	°C

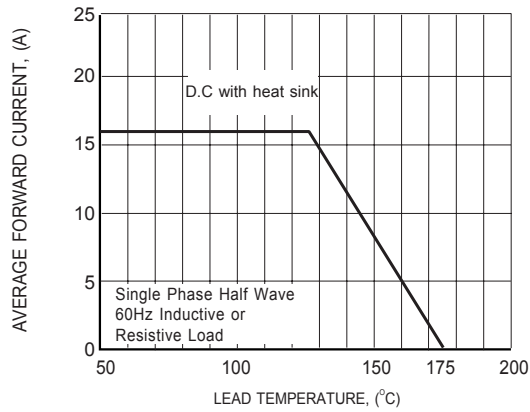
**ELECTRICAL CHARACTERISTICS(@TA=25 °C unless otherwise noted)**

CHARACTERISTICS	SYMBOL	SPKC1645FL	UNITS
Maximum Instantaneous Forward Voltage at 16 A DC	@ $T_A = 25^{\circ}C$	.55	Volts
	@ $T_A = 75^{\circ}C$	.47	
Maximum Average Reverse Current at Rated DC Blocking Voltage	@ $T_A = 25^{\circ}C$	100	uA
	@ $T_A = 75^{\circ}C$	2.5	mA

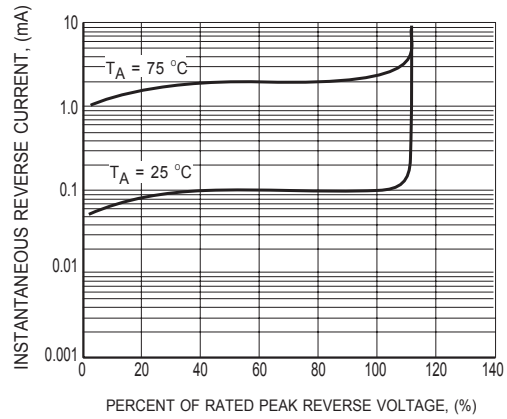
- NOTES : 1. Heat-sink mounted 10mm max from body  
 2. "Fully ROHS compliant", "100% Sn plating (Pb-free)".  
 3. Available in Halogen-free epoxy by adding suffix -HF after the part nbr.

2011-07  
 REV: O

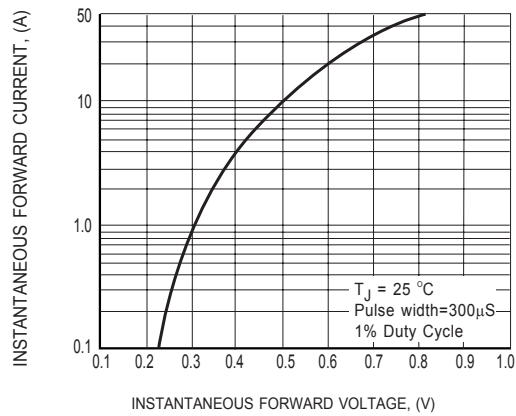
## RATING AND CHARACTERISTICS CURVES ( SPKC1645FL )



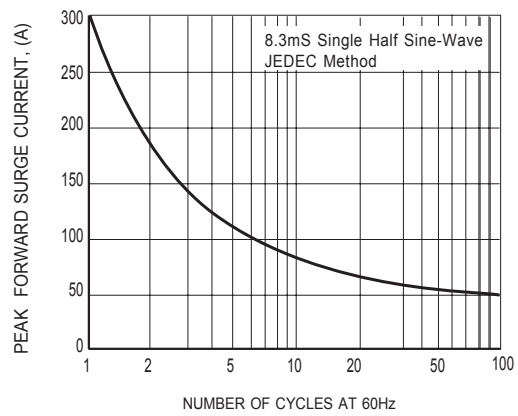
**FIG.1 TYPICAL FORWARD CURRENT DERATING CURVE**



**FIG.2 TYPICAL REVERSE CHARACTERISTICS**

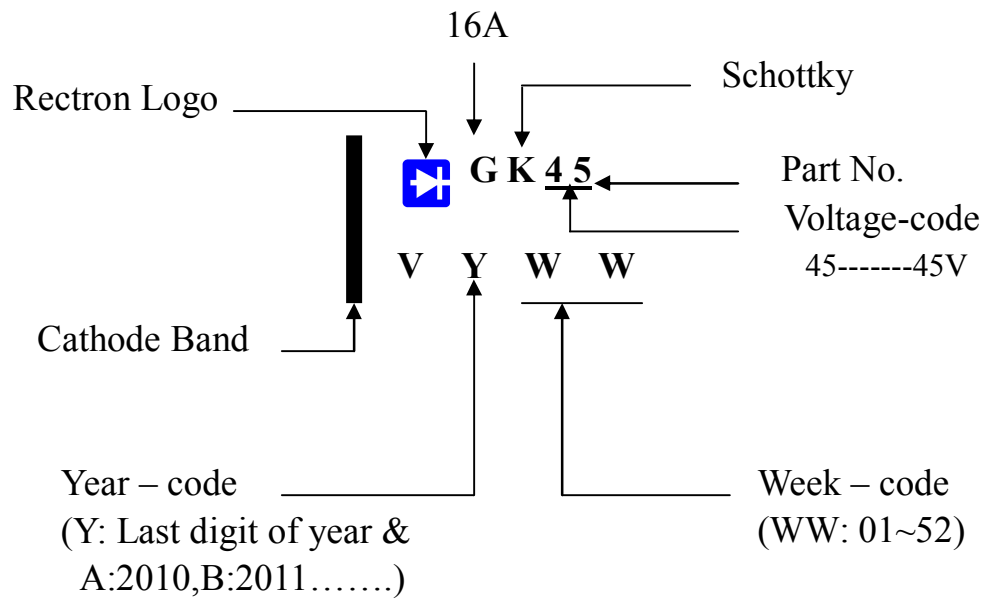


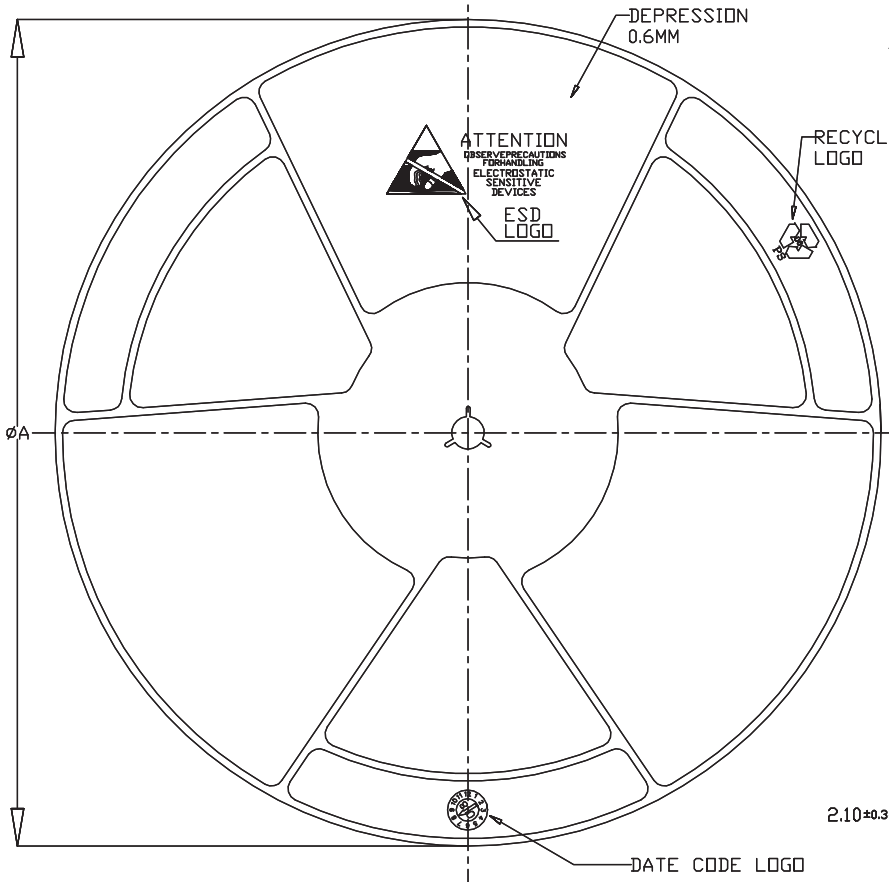
**FIG.3 TYPICAL INSTANTANEOUS FORWARD CHARACTERISTICS**



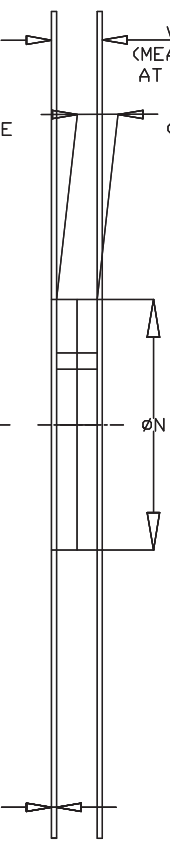
**FIG.4 MAXIMUM NON-REPETITIVE FORWARD SURGE CURRENT**

## Marking Description

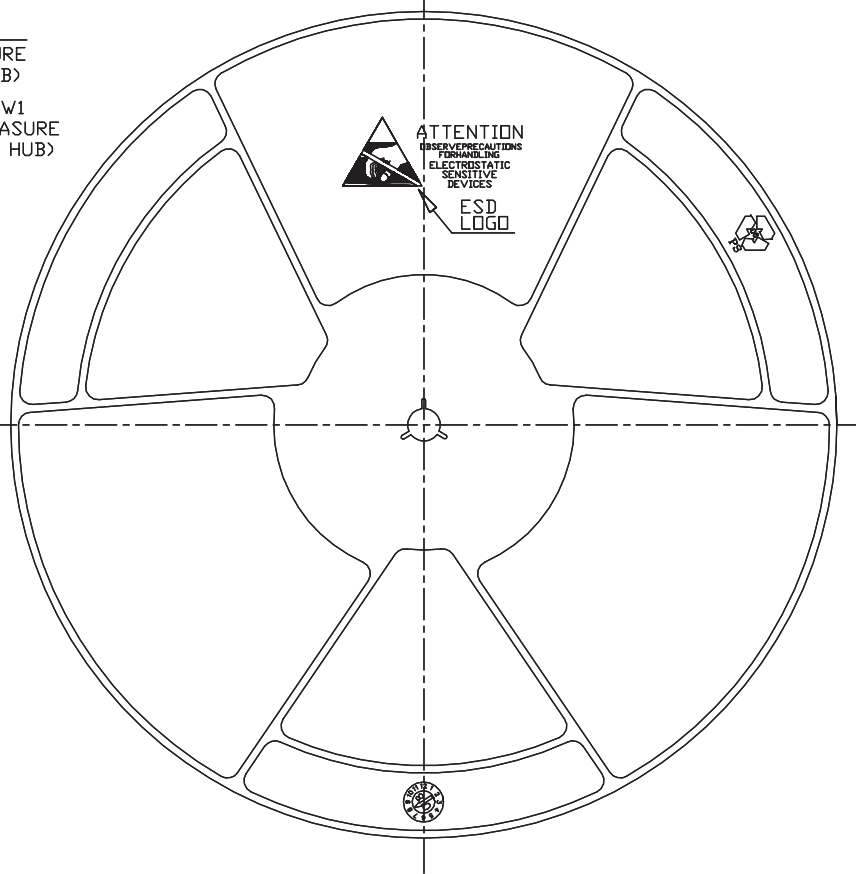




FRONT VIEW

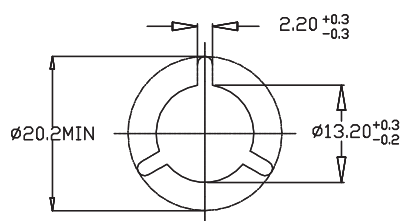


SIDE VIEW



BACK VIEW

PRODUCT SPECIFICATIONS				
TAPE WIDTH	A <sup>±0.2</sup>	N <sup>±0.2</sup>	W1 <sup>±0.3</sup>	W2 (MAX)
44MM	330	100	44.4	51.4



ARBOR HOLE  
DETAIL A  
SCALE 4:1

NOTE:  
1. PRODUCT DRAWING ONLY

TITLE : 13X4 WELDED REEL			
S.R :	--	TOOL NO :	--
SCALE :	NTS	SHRINKAGE :	0.45%
REV :	05/27/20	MATERIAL :	PS X.X ±0.25
UNIT :	MM	WARPAGE :	-- X.XX ±0.13
SHT :	1/1	NAME :	DATE :
			ANGLE :
		DRAWN ZATY	070109 X ±30°
		CHECK KC LEE	070109 X.X ±15°



DWG-REF.	REV.	
42WE0070	A	P

# REEL TAPING SPECIFICATIONS

Unit: mm

## DISCLAIMER NOTICE

Rectron Inc reserves the right to make changes without notice to any product specification herein, to make corrections, modifications, enhancements or other changes. Rectron Inc or anyone on its behalf assumes no responsibility or liability for any errors or inaccuracies. Data sheet specifications and its information contained are intended to provide a product description only. "Typical" parameters which may be included on RECTRON data sheets and/ or specifications can and do vary in different applications and actual performance may vary over time. Rectron Inc does not assume any liability arising out of the application or use of any product or circuit.

Rectron products are not designed, intended or authorized for use in medical, life-saving implant or other applications intended for life-sustaining or other related applications where a failure or malfunction of component or circuitry may directly or indirectly cause injury or threaten a life without expressed written approval of Rectron Inc. Customers using or selling Rectron components for use in such applications do so at their own risk and shall agree to fully indemnify Rectron Inc and its subsidiaries harmless against all claims, damages and expenditures.

