

## 4 PIN DIP RANDOM-PHASE TRIAC DRIVER PHOTOCOUPLER

ELT302X Series  
ELT305X Series

### Features:

- Peak breakdown voltage
  - 400V: ELT302X
  - 600V: ELT305X
- High isolation voltage between input and output (Viso=5000 V rms )
- Compact dual-in-line package
- Pb free and RoHS compliant.
- UL approved (No. E214129)
- VDE approved (No.132249)
- SEMKO approved
- NEMKO approved
- DEMKO approved
- FIMKO approved

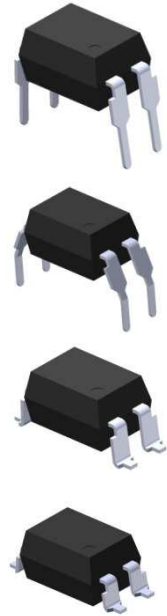

### Description

The ELT302X and ELT305X series of devices each consist of a GaAs infrared emitting diode optically coupled to a monolithic silicon random phase photo Triac.

They are designed for interfacing between electronic controls and power triacs to control resistive and inductive loads for 115 to 240 VAC operations.

### Schematic

### Applications

- Solenoid/valve controls
- Lamp ballasts
- Static AC power switch
- Interfacing microprocessors to 115 to 240Vac peripherals
- Incandescent lamp dimmers
- Temperature controls
- Motor controls

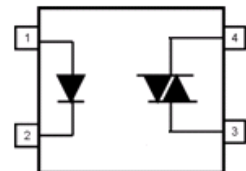

### Pin Configuration

1. Anode
2. Cathode
3. Terminal
4. Terminal

# 4 PIN DIP RANDOM-PHASE TRIAC DRIVER PHOTOCOUPLER

**ELT302X Series**  
**ELT305X Series**

## Absolute Maximum Ratings ( $T_a=25^\circ\text{C}$ )

Parameter		Symbol	Rating	Unit
Input	Forward current	$I_F$	60	mA
	Reverse voltage	$V_R$	6	V
	Power dissipation	$P_D$	100	mW
	Derating factor (above $85^\circ\text{C}$ )		3.8	mW / $^\circ\text{C}$
Output	Off-state Output Terminal Voltage	$V_{DRM}$	ELT302X 400	V
			ELT305X 600	
	Peak Repetitive Surge Current	$I_{TSM}$	1	A
	Power dissipation	$P_D$	300	mW
Derating factor (above $85^\circ\text{C}$ )	7.4		mW / $^\circ\text{C}$	
Isolation voltage <sup>*1</sup>		$V_{iso}$	5000	V rms
Total power dissipation		$P_D$	330	mW
Operating temperature		$T_{opr}$	-55~+100	$^\circ\text{C}$
Storage temperature		$T_{stg}$	-55~+125	$^\circ\text{C}$
Soldering temperature <sup>*2</sup>		$T_{sol}$	260	$^\circ\text{C}$

### Notes

\*1 AC for 1 minute, R.H.= 40 ~ 60% R.H. In this test, pins 1 & 2 are shorted together, and pins 3 & 4 are shorted together.

\*2 For 10 seconds.

## 4 PIN DIP RANDOM-PHASE TRIAC DRIVER PHOTOCOUPLER

ELT302X Series  
ELT305X Series

### Electrical Characteristics (T<sub>a</sub>=25°C unless specified otherwise)

#### Input

Parameter	Symbol	Min.	Typ.*	Max.	Unit	Condition
Forward voltage	V <sub>F</sub>	-	1.18	1.5	V	I <sub>F</sub> = 10mA
Reverse Leakage current	I <sub>R</sub>	-	-	10	μA	V <sub>R</sub> = 6V

#### Output

Parameter	Symbol	Min.	Typ.*	Max.	Unit	Condition	
Peak Blocking Current	I <sub>DRM</sub>	-	-	100	nA	V <sub>DRM</sub> = Rated V <sub>DRM</sub> I <sub>F</sub> = 0mA	
Peak On-state Voltage	V <sub>TM</sub>	-	-	2.5	V	I <sub>TM</sub> =100mA peak, I <sub>F</sub> =Rated I <sub>FT</sub>	
Critical Rate of Rise off-state Voltage	ELT302X	dv/dt	-	100	-	V/μs	V <sub>PEAK</sub> =Rated V <sub>DRM</sub> , I <sub>F</sub> =0 (Fig. 8)
	ELT305X		1000	-	-		

#### Transfer Characteristics

Parameter	Symbol	Min.	Typ.*	Max.	Unit	Condition
LED Trigger Current	ELT3021 ELT3051	-	-	15	mA	Main terminal Voltage=3V
	ELT3022 ELT3052	-	-	10		
	ELT3023 ELT3053	-	-	5		
Holding Current	I <sub>H</sub>	-	250	-	μA	

\* Typical values at T<sub>a</sub> = 25°C

## 4 PIN DIP RANDOM-PHASE TRIAC DRIVER PHOTOCOUPLER

ELT302X Series  
ELT305X Series

### Typical Performance Curves

Figure 1. Forward Current vs Forward Voltage

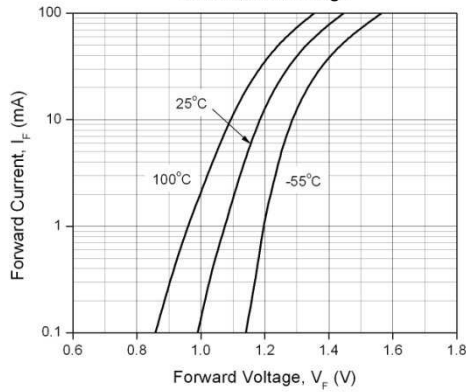

Figure 2. On-State Characteristics

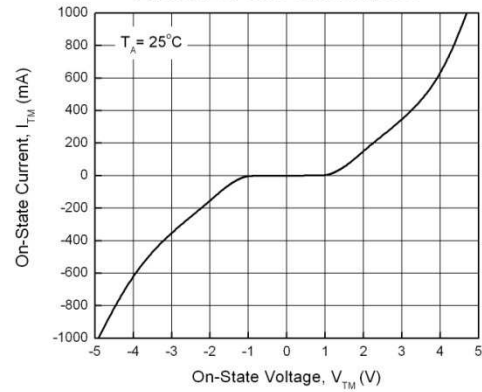

Figure 3. Holding Current vs. Ambient Temperature

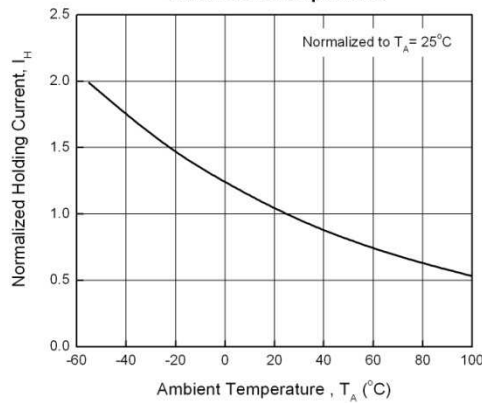

Figure 4. LED Current Required to Trigger vs. LED Pulse Width

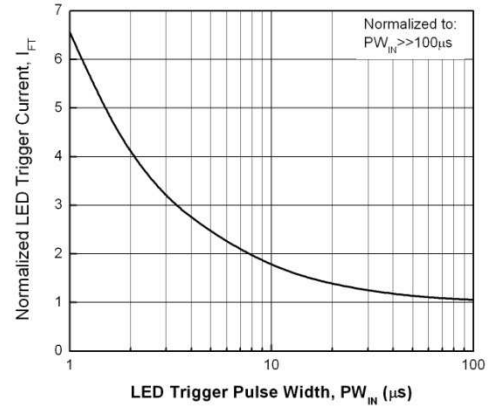

Figure 5. Leakage Current vs. Ambient Temperature

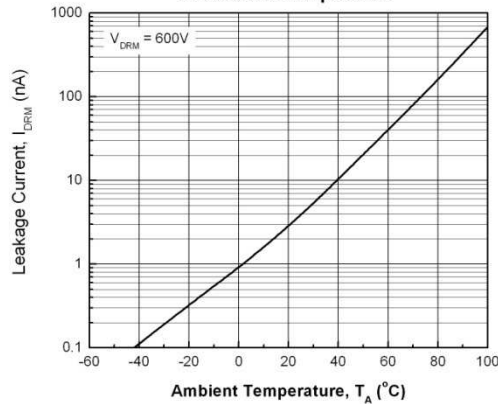
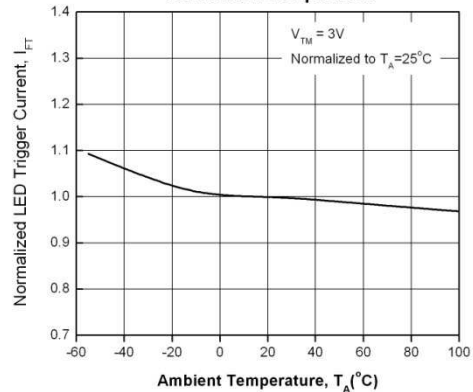

Figure 6. LED Trigger Current vs. Ambient Temperature



4 PIN DIP RANDOM-PHASE TRIAC DRIVER  
PHOTOCOUPLER

ELT302X Series  
ELT305X Series

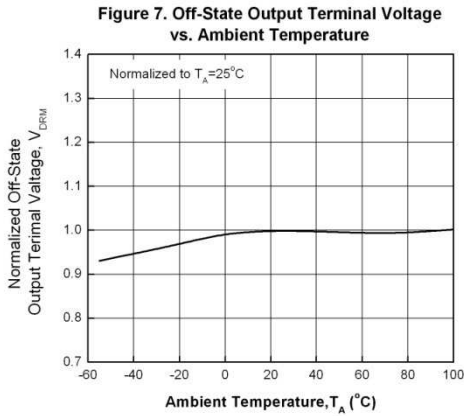
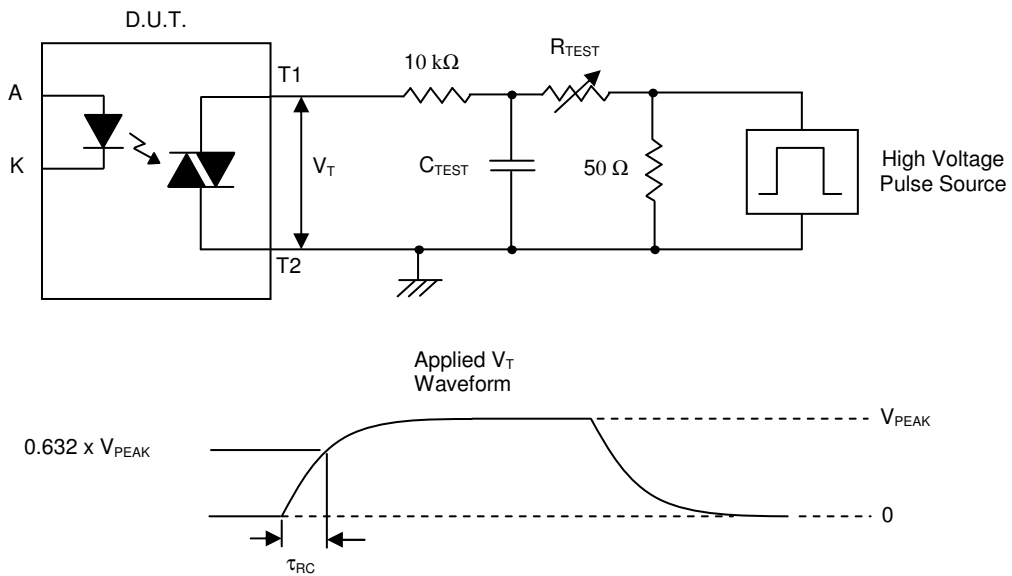

Figure 8. Static dv/dt Test Circuit & Waveform



Measurement Method

The high voltage pulse is set to the required  $V_{PEAK}$  value and applied to the D.U.T. output side through the RC circuit above. LED current is not applied. The waveform  $V_T$  is monitored using a x100 scope probe. By varying  $R_{TEST}$ , the dv/dt (slope) is increased, until the D.U.T. is observed to trigger (waveform collapses). The dv/dt is then decreased until the D.U.T. stops triggering. At this point,  $\tau_{RC}$  is recorded and the dv/dt calculated.

$$dv/dt = \frac{0.632 \times V_{PEAK}}{\tau_{RC}}$$

## 4 PIN DIP RANDOM-PHASE TRIAC DRIVER PHOTOCOUPLER

ELT302X Series  
ELT305X Series

For example,  $V_{PEAK} = 400V$  for ELT302X series. The  $dv/dt$  value is calculated as follows:

$$dv/dt = \frac{0.63 \times 400}{\tau_{RC}} = \frac{252}{\tau_{RC}}$$

### Order Information

#### Part Number

**ELT302XY(Z)-V**  
or **ELT305XY(Z)-V**

#### Note

X = Part No. (1, 2 or 3)

Y = Lead form option (S, S1, M or none)

Z = Tape and reel option (TA, TB, TU, TD or none).

V = VDE safety approved (optional)

Option	Description	Packing quantity
None	Standard DIP-6	100 units per tube
M	Wide lead bend (0.4 inch spacing)	100 units per tube
S (TA)	Surface mount lead form + TA tape & reel option	1000 units per reel
S (TB)	Surface mount lead form + TB tape & reel option	1000 units per reel
S1 (TA)	Surface mount lead form (low profile) + TA tape & reel option	1000 units per reel
S1 (TB)	Surface mount lead form (low profile) + TB tape & reel option	1000 units per reel
S (TU)	Surface mount lead form + TU tape & reel option	1500 units per reel
S (TD)	Surface mount lead form + TD tape & reel option	1500 units per reel
S1 (TU)	Surface mount lead form (low profile) + TU tape & reel option	1500 units per reel
S1 (TD)	Surface mount lead form (low profile) + TD tape & reel option	1500 units per reel

## 4 PIN DIP RANDOM-PHASE TRIAC DRIVER PHOTOCOUPLER

ELT302X Series  
ELT305X Series

### Package Drawings

(Dimensions in mm)

#### Standard DIP Type

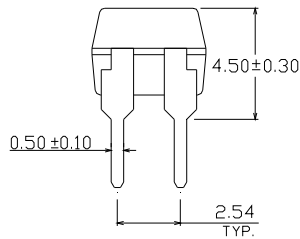
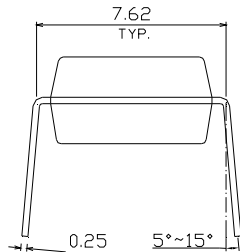
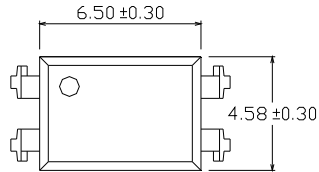

#### Option M Type

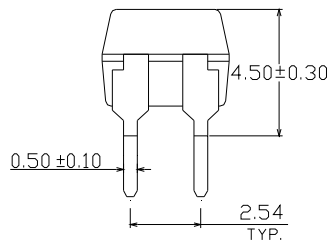
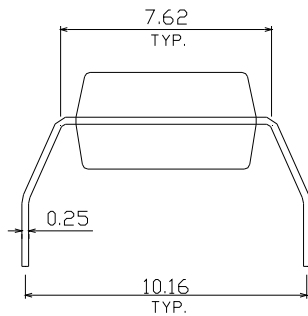
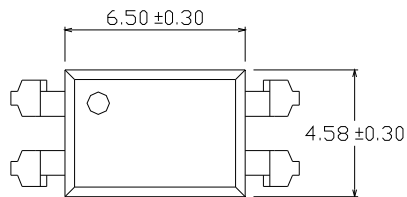

## 4 PIN DIP RANDOM-PHASE TRIAC DRIVER PHOTOCOUPLER

ELT302X Series  
ELT305X Series

### Option S Type

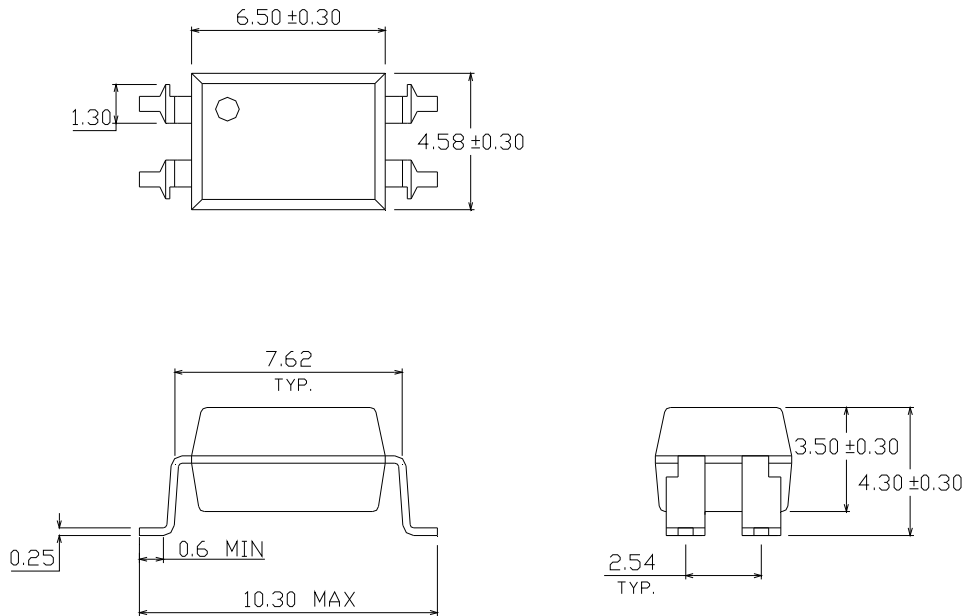

### Option S1 Type

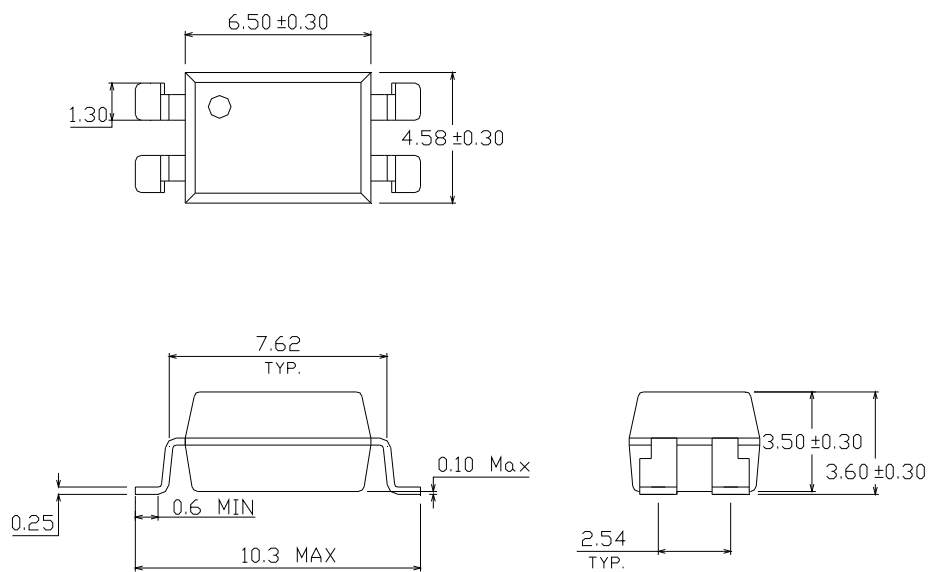



## 4 PIN DIP RANDOM-PHASE TRIAC DRIVER PHOTOCOUPLER

ELT302X Series  
ELT305X Series

Recommended pad layout for surface mount leadform

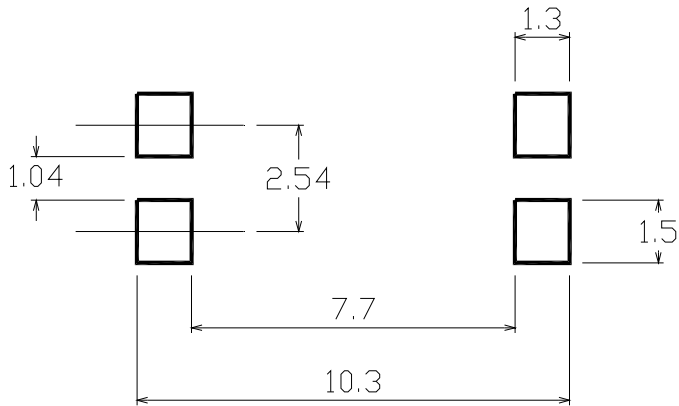

### Device Marking



### Notes

EL denotes Everlight  
T3053 denotes Device Number  
Y denotes 1 digit Year code  
WW denotes 2 digit Week code  
V denotes VDE option

## 4 PIN DIP RANDOM-PHASE TRIAC DRIVER PHOTOCOUPLER

ELT302X Series  
ELT305X Series

### Tape & Reel Packing Specifications

**Option TA**

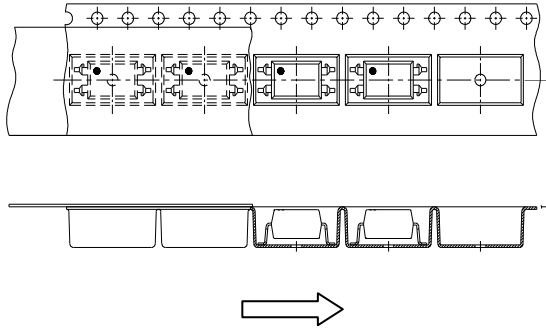

Direction of feed from reel

**Option TB**

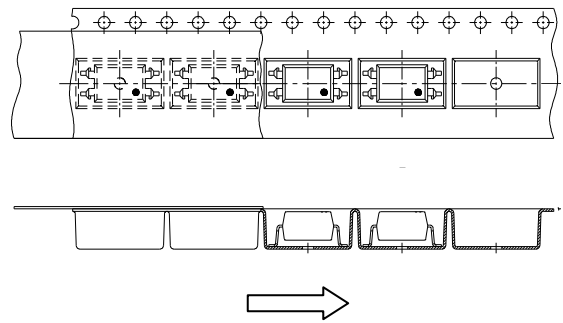

Direction of feed from reel

### Tape dimensions

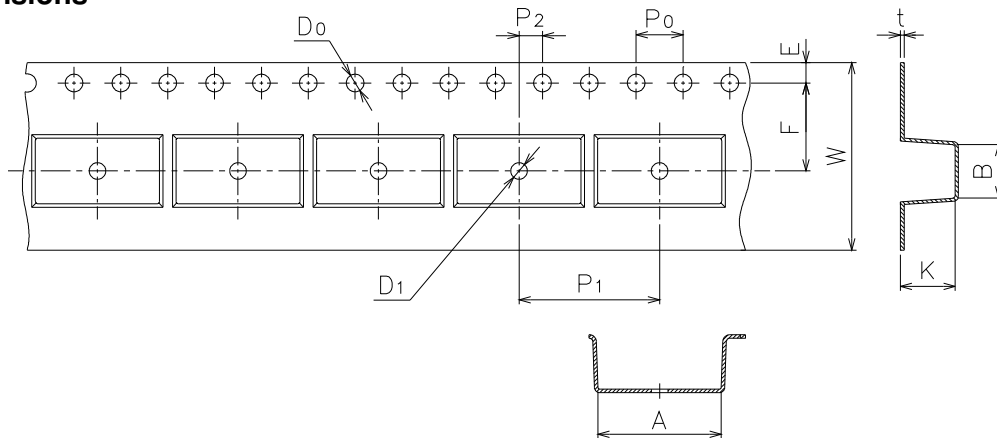

Dimension No.	<b>A</b>	<b>B</b>	<b>Do</b>	<b>D1</b>	<b>E</b>	<b>F</b>
Dimension(mm)	10.4±0.1	4.55±0.1	1.5±0.1	1.5±0.05	1.75±0.1	7.5±0.1
Dimension No.	<b>Po</b>	<b>P1</b>	<b>P2</b>	<b>t</b>	<b>W</b>	<b>K</b>
Dimension(mm)	4.0±0.1	12.0±0.1	2.0±0.1	0.33±0.1	16.0+0.3/ -0.1	4.55±0.1

## 4 PIN DIP RANDOM-PHASE TRIAC DRIVER PHOTOCOUPLER

ELT302X Series  
ELT305X Series

**Option TD**

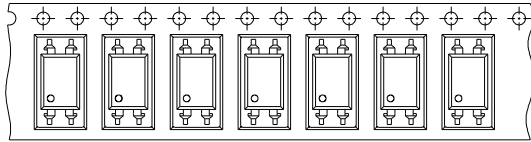

**Option TU**

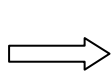
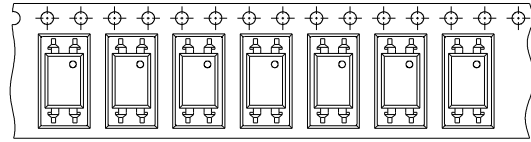

Direction of feed from reel

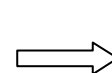

Direction of feed from reel

### Tape dimensions

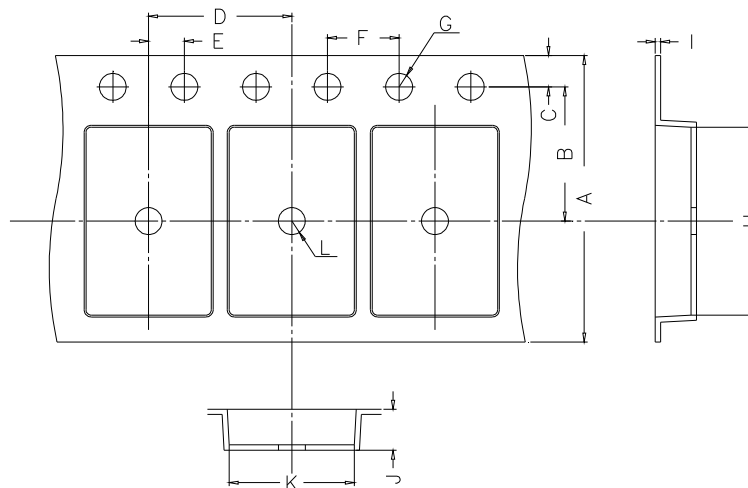

Dimension No.	<b>A</b>	<b>B</b>	<b>C</b>	<b>D</b>	<b>E</b>	<b>F</b>
Dimension(mm)	16.00±0.3	7.5±0.1	1.75±0.1	8.0±0.1	2.0±0.1	4.0±0.1
Dimension No.	<b>G</b>	<b>H</b>	<b>I</b>	<b>J</b>	<b>K</b>	<b>L</b>
Dimension(mm)	1.5+0.1/-0	10.4±0.1	0.4±0.05	4.55±0.1	5.1±0.1	1.5±0.05

## 4 PIN DIP RANDOM-PHASE TRIAC DRIVER PHOTOCOUPLER

ELT302X Series  
ELT305X Series

### Solder Reflow Temperature Profile

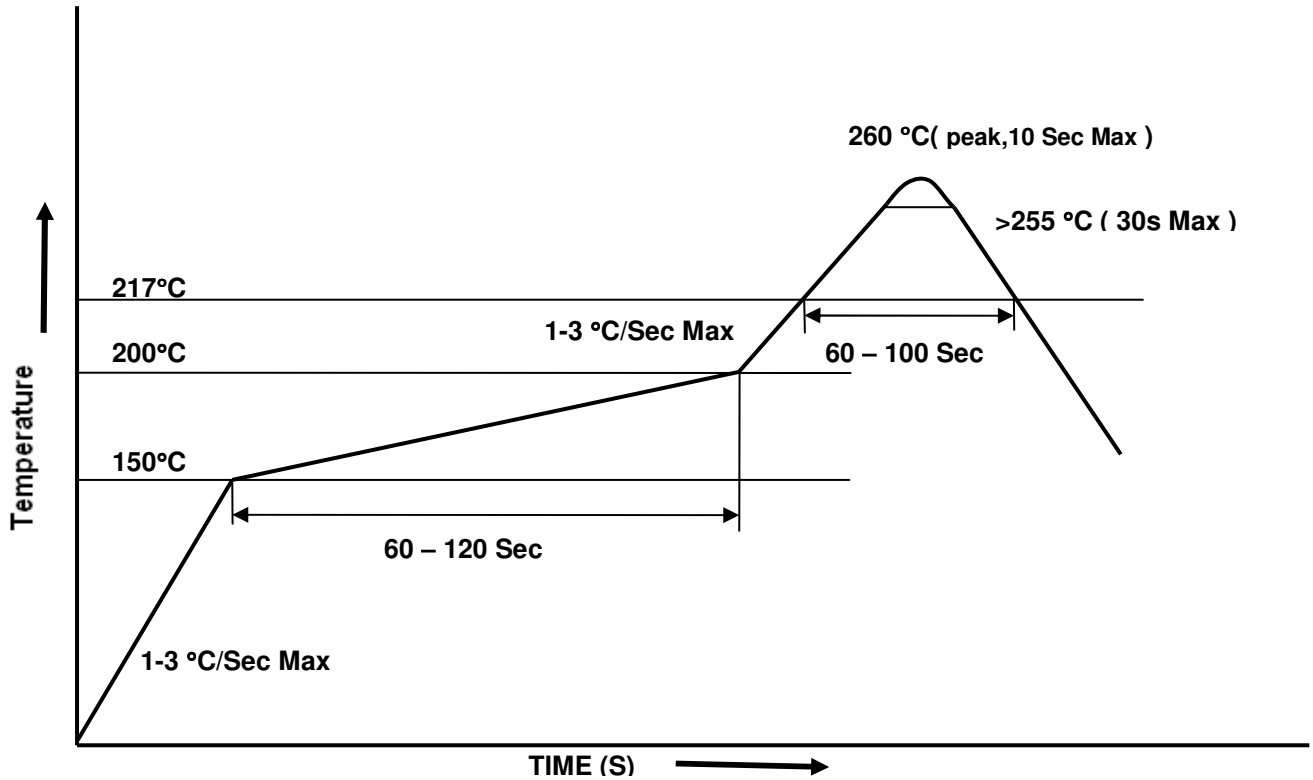

**4 PIN DIP RANDOM-PHASE TRIAC DRIVER  
PHOTOCOUPLER****ELT302X Series  
ELT305X Series**

---

**DISCLAIMER**

1. Above specification may be changed without notice. EVERLIGHT will reserve authority on material change for above specification.
2. When using this product, please observe the absolute maximum ratings and the instructions for use outlined in these specification sheets. EVERLIGHT assumes no responsibility for any damage resulting from use of the product which does not comply with the absolute maximum ratings and the instructions included in these specification sheets.
3. These specification sheets include materials protected under copyright of EVERLIGHT. Reproduction in any form is prohibited without the specific consent of EVERLIGHT.