



EVERLIGHT ELECTRONICS CO.,LTD.



DATA SHEET

PART NO. : 264-7SDRC/S530-A3

DATE : 2000/11/2

DEPARTMENT : CHR&D1

REVISION : 1

RECEIVED			
<input checked="" type="checkbox"/> MASS PRODUCTION			
<input type="checkbox"/> PRELIMINARY			
<input type="checkbox"/> CUSTOMER DESIGN			
DEVICE NUMBER :		CDLE-026-209	
PAGE :		4	
CUSTOMER	DESIGNER	CHECKER	APPROVER
			

1	Revision Update	2000/11/2
REV.	DESCRIPTION	RELEASE DATE

OFFICE : 7C Building, Lian Hua Port Industrial District, Lian Hua Shan
 Bonded Processing Zone, Pan Yu, Guang Zhou, China
 TEL. : (020)84860913,84860914
 FAX : (020)84860600
<http://www.everlight.com>



EVERLIGHT ELECTRONICS CO.,LTD.

Device Number : CDLE-026-209 REV.: 1

3.0mm Round Type LED Lamps

PART NO. : 264-7SDRC/S530-A3 ECN : _____ Page: 1/4

■ Features :

- Choice of various viewing angles
- Available on tape and reel.
- Reliable and robust

■ Descriptions :

- The series is specially designed for applications requiring higher brightness
- The led lamps are available with different colors, intensities, epoxy colors, etc.

■ Applications :

- TV set
- Monitor
- Telephone
- Computer

■ Package Dimensions:

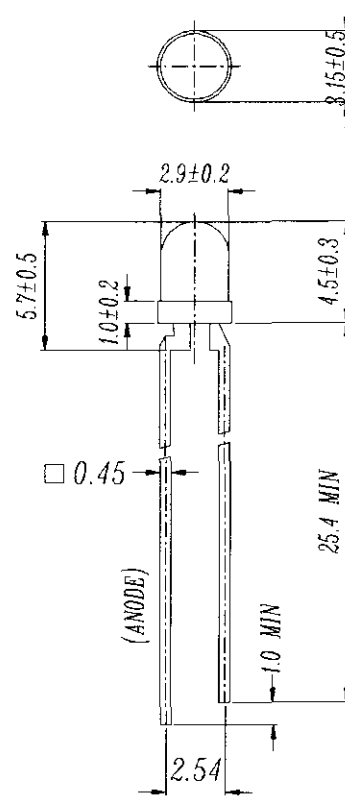

■ Notes :

1. All dimensions are in millimeters.
2. An epoxy meniscus may extend about 1.5mm(0.059") down to the lead.
3. Tolerances unless Dimension ± 0.25 mm.

PART NO.	Chip		Lens Color
	Material	Emitted Color	
264-7SDRC/S530-A3	AlGaInP	Super Deep-Red	Water Clear

OFFICE : 7C Building, Lian Hua Port Industrial District, Lian Hua Shan
Bonded Processing Zone, Pan Yu, Guang Zhou, China

TEL. : (020)84860913,84860914

FAX : (020)84860600

<http://www.everlight.com>

T00632,C89102863



3.0mm Round Type LED Lamps

■ Absolute Maximum Ratings at Ta = 25°C

Parameter	Symbol	Rating	Unit
Forward Current	IF	25	mA
Operating Temperature	Topr	-40 to +85	°C
Storage Temperature	Tstg	-40 to +100	°C
Soldering Temperature	Tsol	260 ± 5	°C
Electrostatic Discharge	ESD	2000	V
Power Dissipation	Pd	60	mW
Peak Forward Current(Duty 1/10 @ 1KHz)	IF(Peak)	160	mA
Reverse Voltage	VR	5	V

■ Electronic Optical Characteristics :

Parameter	Symbol	Min.	Typ.	Max.	Unit	Condition
Luminous Intensity	Iv	40.00	100.00	/	mcd	IF= 20 mA
Viewing Angle	2θ 1/2	/	40	/	deg	IF= 20 mA
Peak Wavelength	λ p	/	650	/	nm	IF= 20 mA
Dominant Wavelength	λ d	/	639	/	nm	IF= 20 mA
Spectrum Radiation Bandwidth	Δ λ	/	20	/	nm	IF= 20 mA
Forward Voltage	VF	1.70	2.00	2.40	V	IF= 20 mA
Reverse Current	IR	/	/	10	μA	VR= 5 V



3.0mm Round Type LED Lamps

■ Typical Electro-Optical Characteristic Curves:

(SDR)

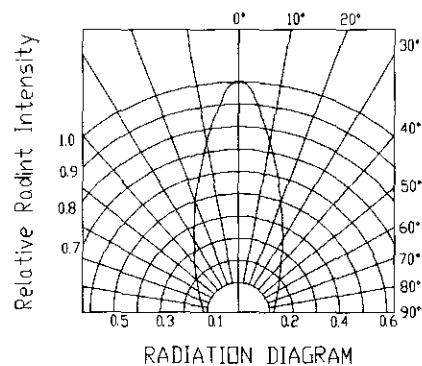
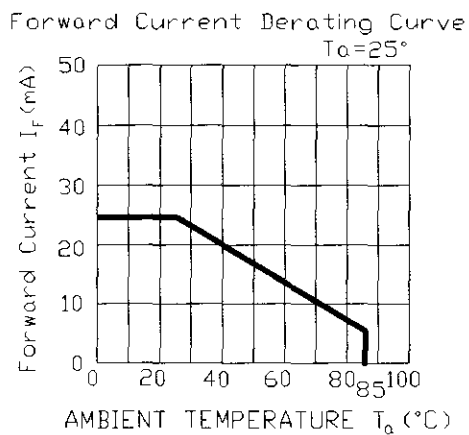
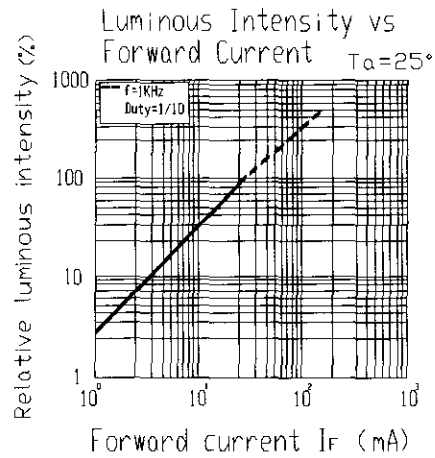
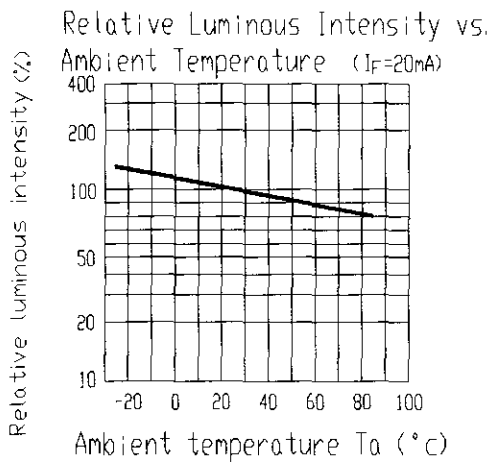
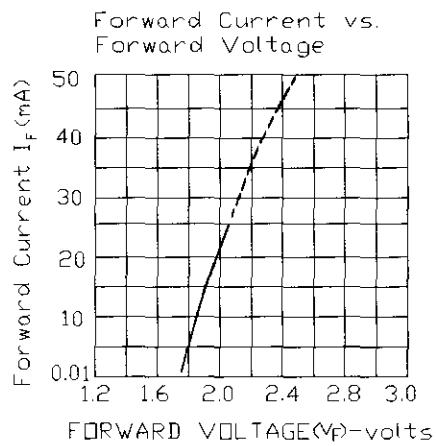
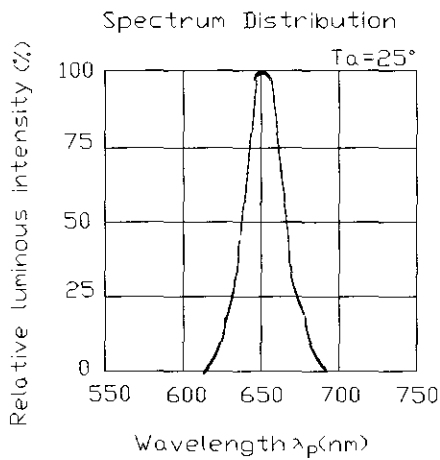



EVERLIGHT ELECTRONICS CO.,LTD.

Device Number : CDLE-026-209 REV.: 1

3.0mm Round Type LED Lamps

PART NO. : 264-7SDRC/S530-A3 ECN : _____ Page: 4/4

■ Reliability test items and conditions:

No	Item	Test Conditions	Test Hours/Cycle	Sample Size	Ac/Re
1	Solder Heat	TEMP : 260°C ± 5 °C	5 SEC	76 PCS	0/1
2	Temperature Cycle	H : +85°C 30min ∫ 5 min L : -55°C 30min	50 CYCLES	76 PCS	0/1
3	Thermal Shock	H : +100°C 5min ∫ 10 sec L : -10°C 5min	50 CYCLES	76 PCS	0/1
4	High Temperature Storage	TEMP : 100°C	1000 HRS	76 PCS	0/1
5	Low Temperature Storage	TEMP : -55°C	1000 HRS	76 PCS	0/1
6	DC Operating Life	If = 20 mA	1000 HRS	76 PCS	0/1
7	High Temperature / High Humidity	85°C /85% RH	1000 HRS	76 PCS	0/1