

EVALUATION KIT
AVAILABLE

Low-Power Comparators with Precision Reference in 4-Bump UCSP

General Description

The MAX9644/MAX9645/MAX9646 are small, single comparators, ideal for a wide variety of portable electronics applications such as cell phones, media players, and notebooks that have extremely tight board space and power constraints. These comparators are offered in both a miniature 4-bump UCSP™ package with a 1mm x 1mm footprint (as small as two 0402 resistors) and a 5-pin SOT23 package.

The ICs feature an input voltage range of -0.3V to +5.5V, independent of supply voltage. These devices maintain high impedance at the inputs even when powered down (V_{CC} or $V_{REF} = 0V$). They also feature internal filtering to provide high RF immunity.

The ICs have an internal 0.2V reference. These devices feature either a push-pull or an open-drain output. They consume only 700nA (max) supply current and operate down to $V_{CC} = 1V$ over the extended -40°C to +85°C temperature range.

Applications

Cell Phones
Portable Media Players
Electronic Toys
Notebook Computers
Portable Medical Devices

Features

- ◆ Tiny, 1mm x 1mm x 0.6mm 4-Bump UCSP Footprint = Two 0402 Resistors
Also Available in a 5-Pin SOT23 Package
- ◆ Ultra-Low Operating Current (700nA max)
- ◆ -0.3V to +5.5V Input Voltage Range
- ◆ Internal 0.2V Reference Trimmed to 1% Accuracy
- ◆ 15µs Propagation Delay
- ◆ -40°C to +85°C Extended Temperature Range

Ordering Information

PART	PIN-PACKAGE	TOP MARK
MAX9644 EBS+G45	4 UCSP	+AGL
MAX9644EUK+	5 SOT23	+AFJN
MAX9645 EBS+G45	4 UCSP	+AGM
MAX9645EUK+	5 SOT23	+AFJO
MAX9646 EBS+G45	4 UCSP	+AGN
MAX9646EUK+	5 SOT23	+AFJP

Note: All devices are specified over the extended -40°C to +85°C operating temperature range.

+Denotes a lead(Pb)-free/RoHS-compliant package.

G45 = Protective die coating.

Selector Guide

PART	REFERENCE VOLTAGE (V)	INPUT	OUTPUT
MAX9644	0.2	Noninverting	Open drain
MAX9645	0.2	Inverting	Open drain
MAX9646	0.2	Noninverting	Push-pull

UCSP is a trademark of Maxim Integrated Products, Inc.



Maxim Integrated Products 1

For pricing, delivery, and ordering information, please contact Maxim Direct at 1-888-629-4642, or visit Maxim's website at www.maxim-ic.com.

MAX9644/MAX9645/MAX9646

Low-Power Comparators with Precision Reference in 4-Bump UCSP

ABSOLUTE MAXIMUM RATINGS

V_{CC}, REF, IN to GND-0.3V to +6V
 OUT to GND (MAX9644/MAX9645).....-0.3V to +6V
 OUT to GND (MAX9646 only)-0.3V to + (V_{CC} + 0.3V)
 Output Short-Circuit Current Duration10s
 Input Current into Any Terminal.....±20mA
 Continuous Power Dissipation
 4-Bump UCSP (derate 3.0mW/°C above +70°C)238 mW
 5-Pin SOT23 (derate 3.9mW/°C above +70°C).....312 mW

Operating Temperature Range-40°C to +85°C
 Junction Temperature+150°C
 Storage Temperature Range-65°C to +150°C
 Bump Temperature (soldering) Reflow.....+235°C
 Lead Temperature (soldering, 10s)+300°C
 Soldering Temperature (reflow)+260°C

Stresses beyond those listed under "Absolute Maximum Ratings" may cause permanent damage to the device. These are stress ratings only, and functional operation of the device at these or any other conditions beyond those indicated in the operational sections of the specifications is not implied. Exposure to absolute maximum rating conditions for extended periods may affect device reliability.

ELECTRICAL CHARACTERISTICS

(V_{CC} = 3.3V, R_{PULLUP} = 10kΩ to V_{PULLUP} = 3.3V for MAX9644/MAX9645, T_A = -40°C to +85°C. Typical values at T_A = +25°C, unless otherwise noted.) (Note 1)

PARAMETER	SYMBOL	CONDITIONS	MIN	TYP	MAX	UNITS
DC CHARACTERISTICS						
Input Voltage Range	V _{IN}	Guaranteed by I _{IN} test	-0.3		+5.5	V
Input Bias Current	I _{IN}	V _{IN} = 0.2V to 5.5V (Note 2)		0.06	15	nA
Input Leakage Current	I _{IN_SHDN}	V _{CC} = 0, V _{IN} = 5.5V (Note 2)		< 0.1	15	nA
Output Voltage Low	V _{OL}	I _{SINK} = 50μA, V _{CC} = 1.0V		0.03	0.2	V
		I _{SINK} = 200μA, V _{CC} = 1.2V		0.08	0.20	
		I _{SINK} = 500μA, V _{CC} = 1.8V		0.13	0.23	
		I _{SINK} = 0.75mA, V _{CC} = 3.3V		0.14	0.3	
		I _{SINK} = 1.2mA, V _{CC} = 5.5V		0.19	0.5	
Output Voltage High (MAX9464 Only)	V _{OH}	I _{SOURCE} = 15μA, V _{CC} = 1.0V		V _{CC} - 0.08V	V _{CC} - 0.2V	V
		I _{SOURCE} = 40μA, V _{CC} = 1.2V		V _{CC} - 0.08V	V _{CC} - 0.20V	
		I _{SOURCE} = 180μA, V _{CC} = 1.8V		V _{CC} - 0.15V	V _{CC} - 0.23V	
		I _{SOURCE} = 0.3mA, V _{CC} = 3.3V		V _{CC} - 0.13V	V _{CC} - 0.3V	
		I _{SOURCE} = 0.75mA, V _{CC} = 5.5V		V _{CC} - 0.24V	V _{CC} - 0.5V	
Output Leakage Current (MAX9644/MAX9645 Only)	I _{OUT_LEAKAGE}	OUT = high, V _{PULLUP} = 5.5V (Note 2)		< 0.1	15	nA
AC CHARACTERISTICS						
Propagation Delay	t _{PD}	V _{OVERDRIVE} = ±100mV (Note 3)		15		μs
Fall Time	t _F	C _L = 10pF		14		ns
Rise Time	t _R	C _L = 10pF, MAX9646 only		30		ns
REFERENCE VOLTAGE						
Input Threshold (Note 4)	V _{REF}	MAX964_EBS+		200		mV
		MAX964_EUK+		199		
Input Threshold Error (Note 4)	Delta-V _{REF}	T _A = +25°C	-1		+1	%
		T _A = -40°C to +85°C	-3.5		+3.5	
Input Threshold Hysteresis	V _{HYS}	T _A = -40°C to +85°C (Note 5)		±0.9		mV
REF Tempco	V _{REF_TEMP}	(Note 6)		6		μV/°C
Power-Supply Rejection Ratio	PSRR	V _{CC} = 1.0V to 5.5V	40	53		dB

Low-Power Comparators with Precision Reference in 4-Bump UCSP

MAX9644/MAX9645/MAX9646

ELECTRICAL CHARACTERISTICS

($V_{CC} = 3.3V$, $R_{PULLUP} = 10k\Omega$ to $V_{PULLUP} = 3.3V$ for MAX9644/MAX9645, $T_A = -40^\circ C$ to $+85^\circ C$. Typical values at $T_A = +25^\circ C$, unless otherwise noted.) (Note 1)

PARAMETER	SYMBOL	CONDITIONS	MIN	TYP	MAX	UNITS
POWER SUPPLY						
Supply Voltage	V_{CC}	Guaranteed by V_{OL}/V_{OH} tests	1.0		5.5	V
Supply Current	I_{CC}	$V_{CC} = 1.0V$		0.4	0.7	μA
		$V_{CC} = 5.5V$		0.6	1.1	
Power-Up Time	t_{ON}			3		ms

Note 1: All devices are 100% production tested at $T_A = +25^\circ C$. Temperature limits are guaranteed by design.

Note 2: Too small to be measured in an ATE test environment. Only gross test to catch failures is implemented.

Note 3: Overdrive is defined as the voltage above or below the switching points.

Note 4: Guaranteed by ATE and/or bench characterization over temperature. V_{REF} is the average of the trip points.

Note 5: Hysteresis is half the input voltage difference between the two switching points.

Note 6: Includes reference error along with comparator offset voltage error.

Typical Operating Characteristics

($V_{CC} = 3.3V$, $V_{REF} = 1.8V$, $R_{PULLUP} = 10k\Omega$ to $V_{PULLUP} = 3.3V$ for MAX9644/MAX9645, $GND = 0$, $T_A = +25^\circ C$, unless otherwise noted.)

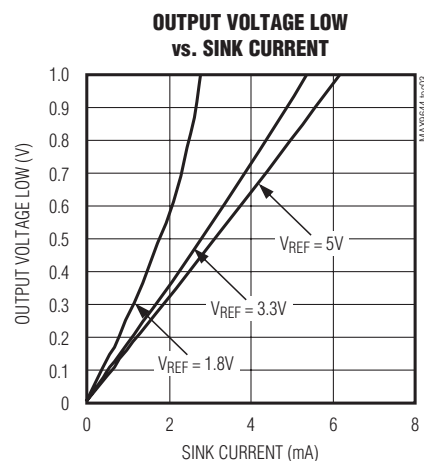
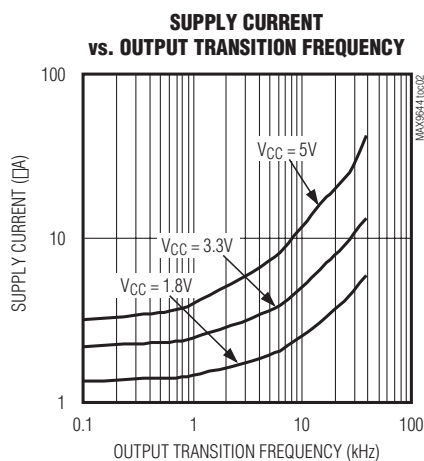
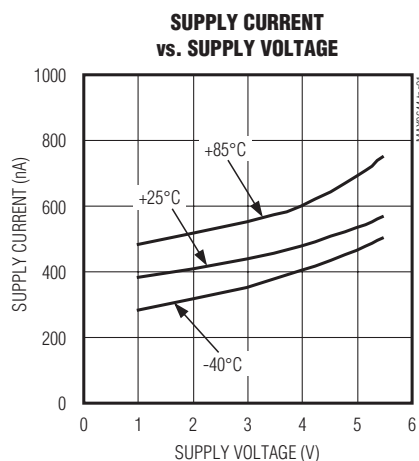

Low-Power Comparators with Precision Reference in 4-Bump UCSP

Typical Operating Characteristics

($V_{CC} = 3.3V$, $V_{REF} = 1.8V$, $R_{PULLUP} = 10k\Omega$ to $V_{PULLUP} = 3.3V$ for MAX9644/MAX9645, $GND = 0$, $T_A = +25^\circ C$, unless otherwise noted.)

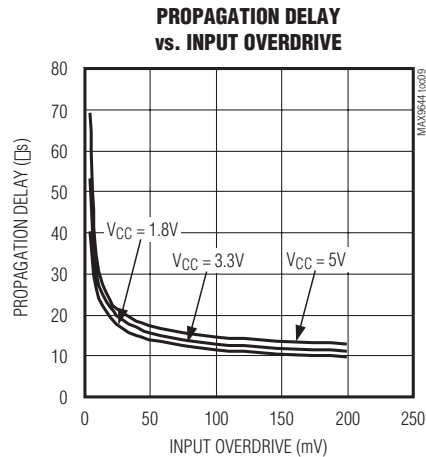
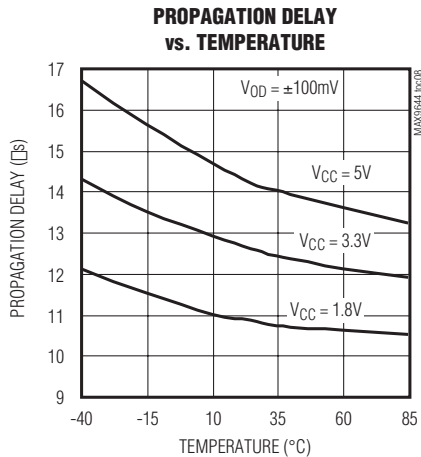
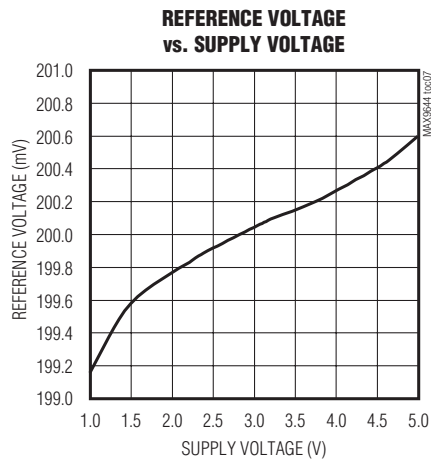
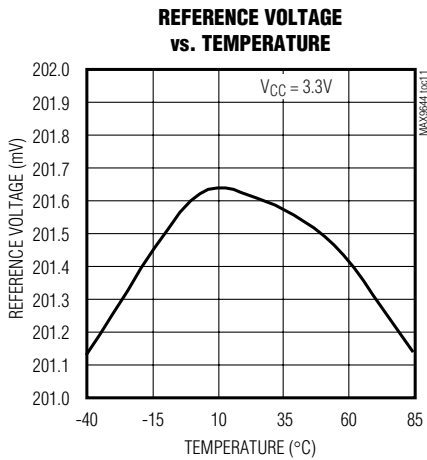
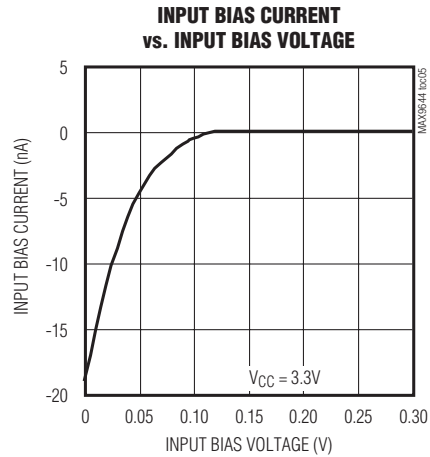
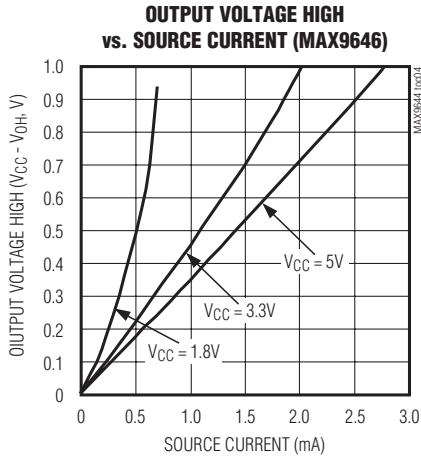

Low-Power Comparators with Precision Reference in 4-Bump UCSP

Typical Operating Characteristics (continued)

($V_{CC} = 3.3V$, $V_{REF} = 1.8V$, $R_{PULLUP} = 10k\Omega$ to $V_{PULLUP} = 3.3V$ for MAX9644/MAX9645, $GND = 0$, $T_A = +25^\circ C$, unless otherwise noted.)

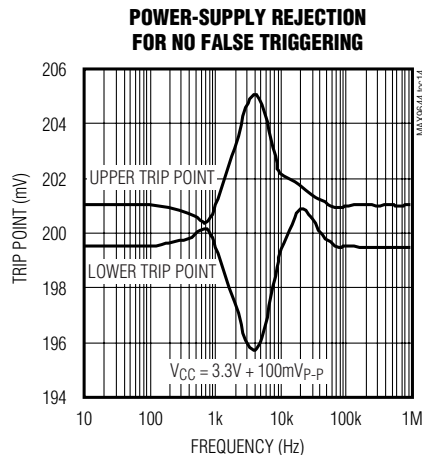
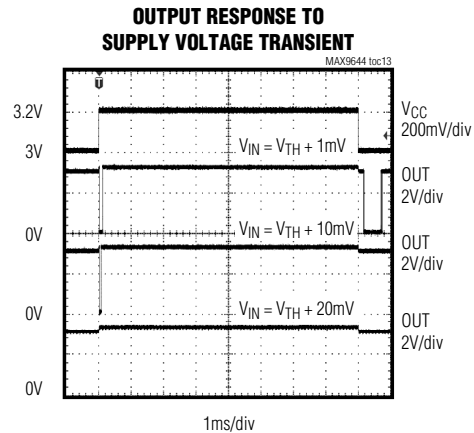
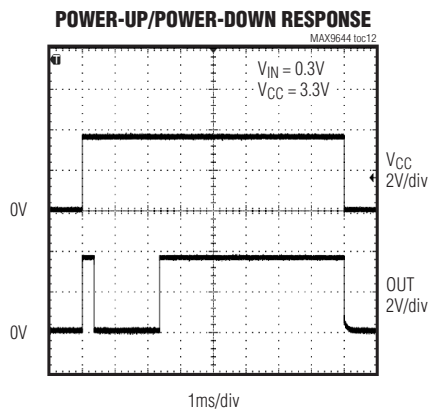
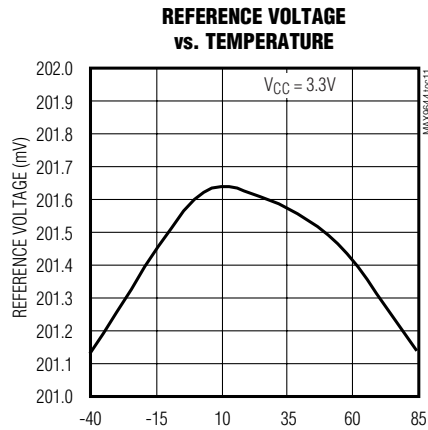
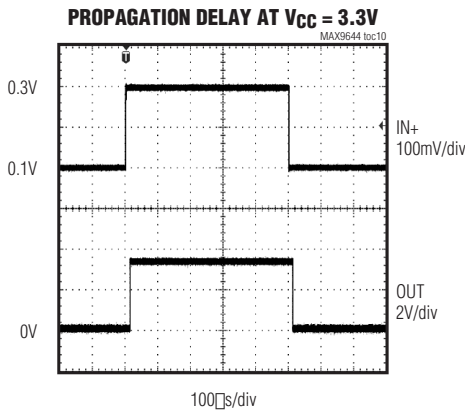

MAX9644/MAX9645/MAX9646

Low-Power Comparators with Precision Reference in 4-Bump UCSP

Pin Configuration

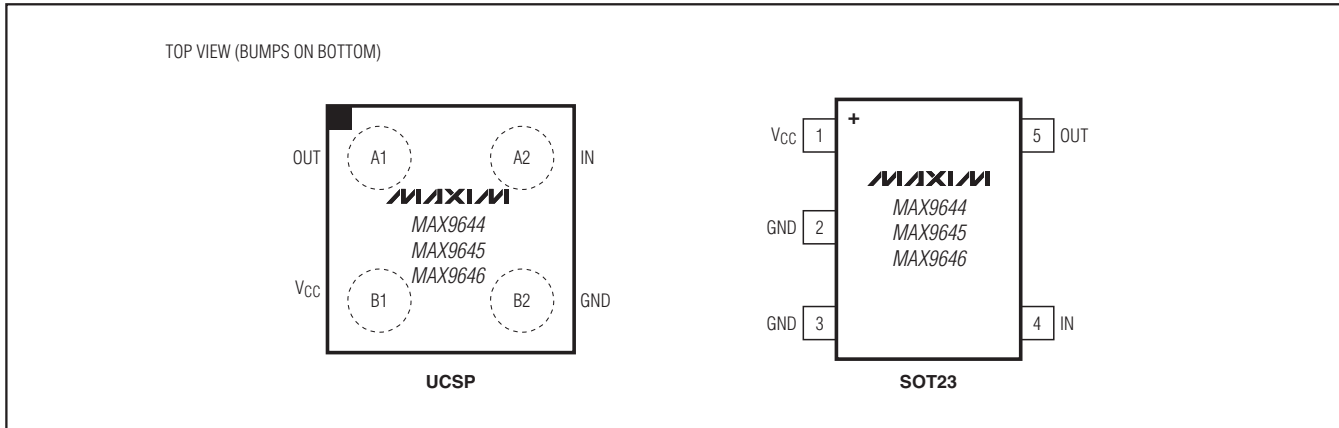

Pin Description

PIN		NAME	FUNCTION
UCSP	SOT23		
A1	5	OUT	Comparator Output. The MAX9644/MAX9645 have open-drain outputs. The MAX9646 has a push-pull output.
A2	4	IN	Comparator Input. The MAX9644/MAX9646 have noninverting inputs. The MAX9645 has inverting inputs.
B1	1	V _{CC}	Power-Supply Voltage. Bypass to ground with a 0.1µF bypass capacitor.
B2	2, 3	GND	Ground

Low-Power Comparators with Precision Reference in 4-Bump UCSP

MAX9644/MAX9645/MAX9646

Detailed Description

The MAX9644/MAX9645/MAX9646 are extremely small comparators ideal for compact, low-current, and low-voltage applications.

The ICs consume only 400nA (typ). The low-voltage operating capability of the operating current makes these devices extremely attractive to long-life battery-operated devices—these applications can now use a single digital power-supply rail to power the new generation of microcontrollers (which can be down to 0.9V). All parts are available in a tiny 4-bump UCSP, which is only 0.6mm tall and occupies a 1mm x 1mm footprint and a 5-pin SOT23.

Input Stage Circuitry

Noninverting inputs are available on the MAX9644/MAX9646 and inverting inputs are available on the MAX9645.

The MAX9644/MAX9645/MAX9646 incorporate an innovative input stage architecture that allows their input voltage to exceed V_{CC} by several volts (limited only by the *Absolute Maximum Ratings*). This is unlike traditional comparators that have an input ESD diode clamp between the input and V_{CC} , limiting this maximum over-voltage to about 0.3V. The ICs architecture maintains a high input impedance to input signals even when the device power-supply voltage is completely turned off (V_{CC} or REF taken to 0V). This greatly benefits flexible power-saving schemes to be easily implemented in advanced battery-operated devices. On-chip filtering provides immunity from any RF noise being picked up by input traces. These devices feature an internal temperature-compensated, low-power 0.2V reference voltage.

Output Stage Structure

The MAX9644/MAX9645 have open-drain outputs that allow them to interface to logic circuitry running from supply voltages other than the one supplied to the part. These devices require an external pullup resistor or current source for proper operation. Many microcontroller digital inputs ports can be readily programmed to include these.

The MAX9646 has a push-pull output stage that can both sink and source current, eliminating the need for an external pullup resistor. In this case, the MAX9646 uses the microcontroller's power supply as V_{CC} .

Applications Information

Bypassing REF/V_{CC}

Place a 0.1μF capacitor between REF or V_{CC} and GND as close as possible to the device. During a switching event, all comparators draw a current spike from their power-supply rails. This current spike is minimized by the use of an internal break-before-make design.

Hysteresis Operation

The ICs feature internal hysteresis for noise immunity and glitch-free operation. If additional hysteresis is needed, an external positive feedback network can be easily implemented on the MAX9644 and MAX9646 non-inverting input devices. Additional external hysteresis is not possible on the MAX9645 because the noninverting input of the comparator is not externally accessible.

Table 1. How Devices Behave Under Various Input Voltage Conditions

PART	INPUT VOLTAGE CONDITIONS	ACTION AT OUTPUT
MAX9644	$V_{IN} > 0.2V$	External pullup resistor pulls output high.
	$V_{IN} < 0.2V$	Output asserts low.
MAX9645	$V_{IN} > 0.2V$	Output asserts low.
	$V_{IN} < 0.2V$	External pullup resistor pulls output high.
MAX9646	$V_{IN} > 0.2V$	Output asserts high.
	$V_{IN} < 0.2V$	Output asserts low.

Low-Power Comparators with Precision Reference in 4-Bump UCSP

Typical Operating Circuits

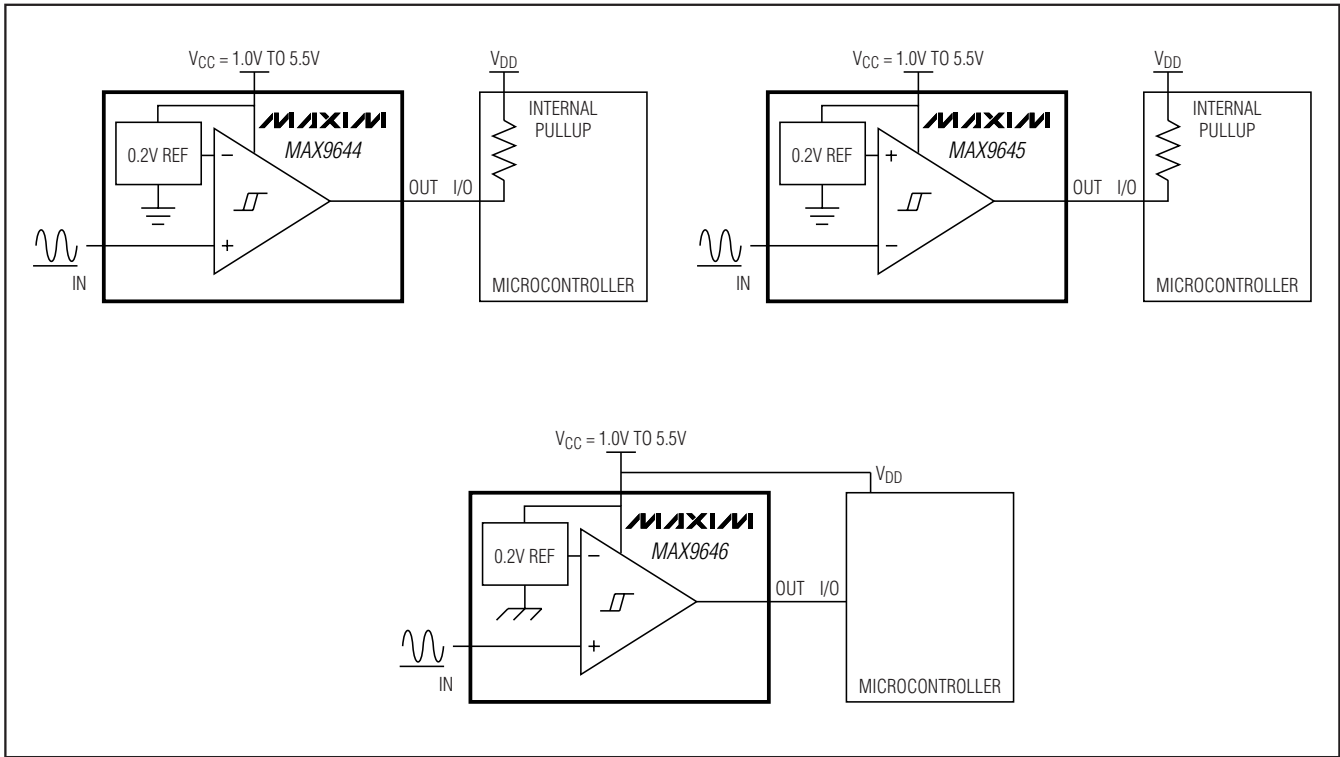

Chip Information

PROCESS: BiCMOS

Low-Power Comparators with Precision Reference in 4-Bump UCSP

Package Information

For the latest package outline information and land patterns (footprints), go to www.maxim-ic.com/packages. Note that a "+", "#", or "-" in the package code indicates RoHS status only. Package drawings may show a different suffix character, but the drawing pertains to the package regardless of RoHS status.

PACKAGE TYPE	PACKAGE CODE	DOCUMENT NO.	LAND PATTERN NO.
4 UCSP	B4+1	21-0117	Refer to Application Note 1891
5 SOT23	U5+2	21-0057	90-0174

PIN 1 MARK AREA
PRODUCT MARKING
AAA

TOP VIEW

COMMON DIMENSIONS	
A	0.62±0.05-0.08
A1	0.29±0.02
A2	0.33 REF.
b	∅0.35±0.03
D1	0.50 BASIC
E1	0.50 BASIC
e	0.50 BASIC
SD	0.25 BASIC
SE	0.25 BASIC

PKG. CODE	VARIABLE DIMENSIONS		DEPOPULATED SOLDER BALLS
	D	E	
B4-1	1.00±0.05	1.00±0.05	NONE
B4-2	1.05±0.05	1.05±0.05	NONE
B4-3	1.10±0.05	1.10±0.05	NONE

PIN A1 INDICATOR

BOTTOM VIEW

0.025-0.05 Backside Coat (Optional)

SIDE VIEW

NOTES:

- ALL DIMENSIONS ARE IN MILLIMETERS UNLESS OTHERWISE SPECIFIED.
- MATERIAL MUST COMPLY WITH BANNED AND RESTRICTED SUBSTANCES SPEC #10-0131.
- OUTER DIMENSION (D & E) IS DEFINES BY CENTER LINES BETWEEN SCRIBE LINES.
- MARKING SHOWN IS FOR PACKAGE ORIENTATION REFERENCE ONLY. NUMBER OF CHARACTERS AND LINES VARY PER PRODUCT.
- ALL DIMENSIONS APPLY BOTH TO LEAD FREE (+) & LEADED (-) PKG. CODES.
- PACKAGE CODE: B4-1, B4-2, B4-3

TITLE:
PACKAGE OUTLINE, 4 BUMPS UCSP (B),
2X2 ARRAY

APPROVAL	DOCUMENT CONTROL NO. 21-0117	REV. I	1/1
----------	---------------------------------	-----------	-----

-DRAWING NOT TO SCALE-

MAX9644/MAX9645/MAX9646

Low-Power Comparators with Precision Reference in 4-Bump UCSP

Package Information (continued)

For the latest package outline information and land patterns (footprints), go to www.maxim-ic.com/packages. Note that a "+", "#", or "-" in the package code indicates RoHS status only. Package drawings may show a different suffix character, but the drawing pertains to the package regardless of RoHS status.

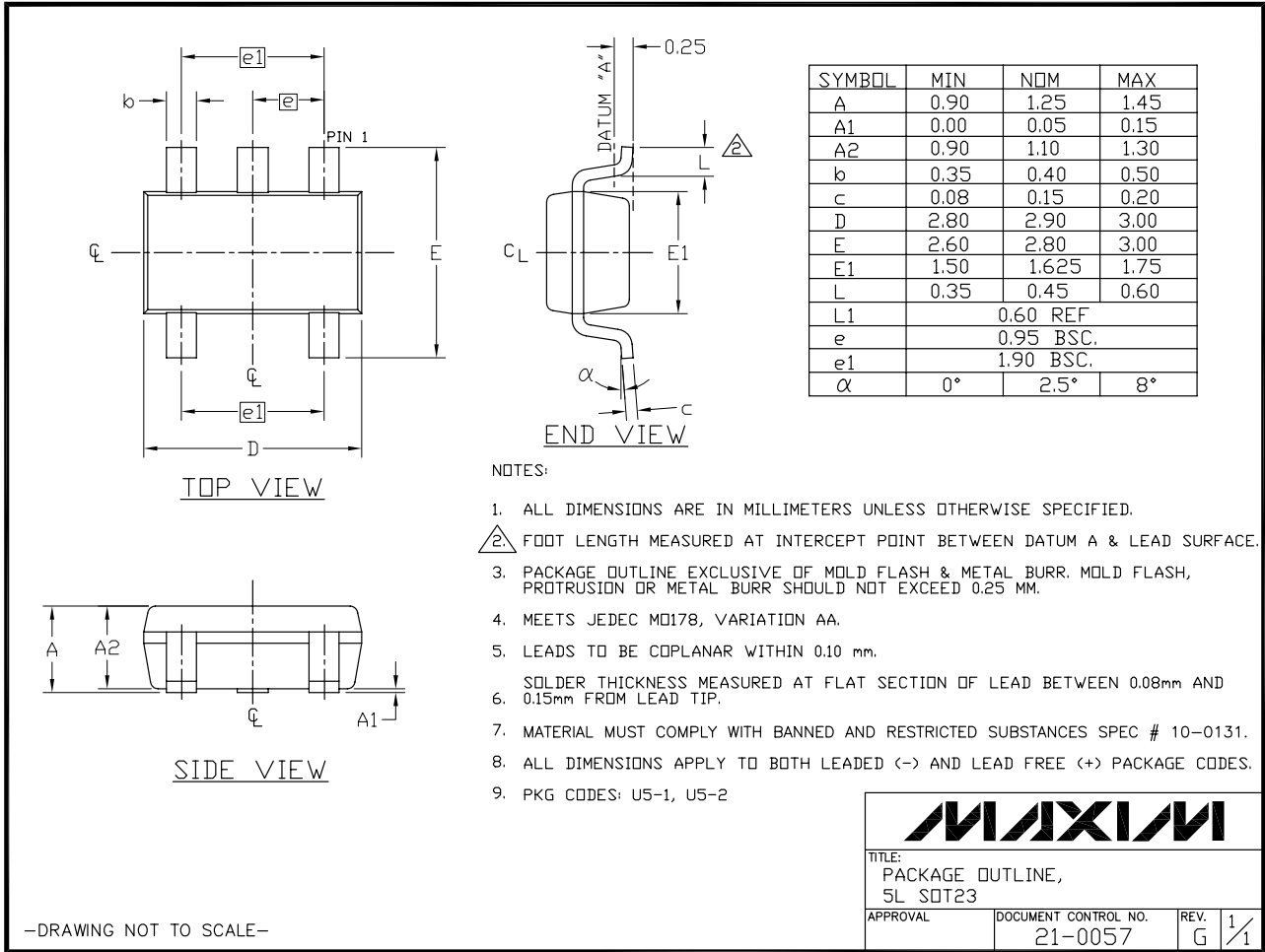

Low-Power Comparators with Precision Reference in 4-Bump UCSP

Revision History

REVISION NUMBER	REVISION DATE	DESCRIPTION	PAGES CHANGED
0	3/11	Initial release	—
1	10/11	Updated <i>Features</i> section	1

MAX9644/MAX9645/MAX9646

Maxim cannot assume responsibility for use of any circuitry other than circuitry entirely embodied in a Maxim product. No circuit patent licenses are implied. Maxim reserves the right to change the circuitry and specifications without notice at any time.

Maxim Integrated Products, 120 San Gabriel Drive, Sunnyvale, CA 94086 408-737-7600 _____ 11