

2-line IPAD™, EMI filter and ESD protection

Features

- EMI symmetrical (I/O) low-pass filter
- High efficiency in EMI filtering
- Lead-free package
- Very low PCB space occupation:
1.42 mm x 0.92 mm
- Very thin package: 0.65 mm
- High efficiency in ESD suppression
- High reliability offered by monolithic integration
- High reducing of parasitic elements through integration and wafer level packaging

Complies with the following standards

- IEC 61000-4-2 level 4 on input pins
 - 15 kV (air discharge)
 - 8 kV (contact discharge)
- IEC 61000-4-2 level 1 on input pins
 - 2 kV (air discharge)
 - 2 kV (contact discharge)

Applications

Where EMI filtering in ESD sensitive equipment is required:

- Mobile phones and communication systems
- Computers, printers and MCU Boards

Description

The EMIF02-MIC02 is a highly integrated device designed to suppress EMI/RFI noise in all systems subjected to electromagnetic interference. The EMIF02 Flip-Chip packaging means the package size is equal to the die size.

This filter includes an ESD protection circuitry which prevents damage to the application when subjected to ESD surges up 15 kV.

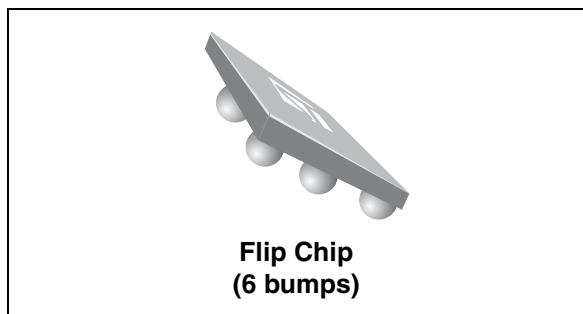

Figure 1. Pin configuration (bump side)

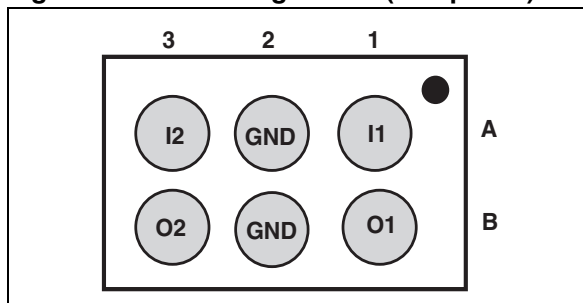
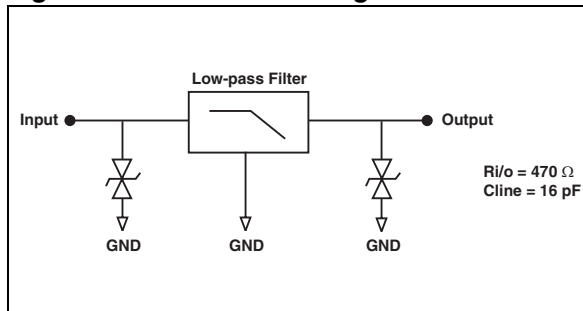

Figure 2. Basic cell configuration



TM: IPAD is a trademark of STMicroelectronics.

1 Electrical characteristics

Table 1. Absolute ratings ($T_{amb} = 25\text{ }^{\circ}\text{C}$)

Symbol	Parameter	Value	Unit
T_j	junction temperature	125	$^{\circ}\text{C}$
T_{op}	Operating temperature range	-40 to +85	$^{\circ}\text{C}$
T_{stg}	Storage temperature range	-55 to 150	$^{\circ}\text{C}$

Table 2. Electrical characteristics ($T_{amb} = 25\text{ }^{\circ}\text{C}$)

Symbol	Parameters				
V_{BR}	Breakdown voltage				
I_{RM}	Leakage current @ V_{RM}				
V_{RM}	Stand-off voltage				
V_{CL}	Clamping voltage				
R_d	Dynamic impedance				
I_{PP}	Peak pulse current				
$R_{I/O}$	Series resistance between input and output				
C_{line}	Input capacitance per line				
Symbol	Test conditions				
V_{BR}	$I_R = 1\text{ mA}$	14	16		V
I_{RM}	$V_{RM} = 12\text{ V per line}$			500	nA
$R_{I/O}$		423	470	517	Ω
C_{line}	@ 0 V		16	20	pF

Figure 3. Attenuation measurement and Aplac simulation

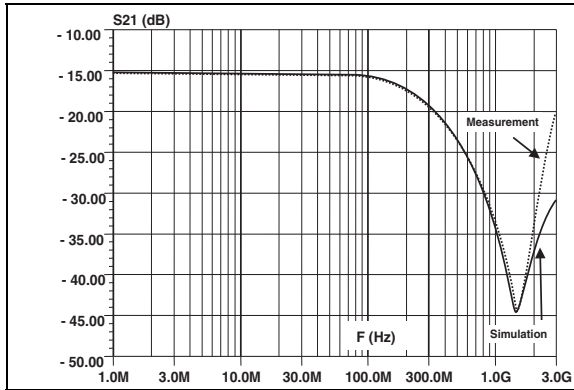

Figure 4. Analog crosstalk measurements

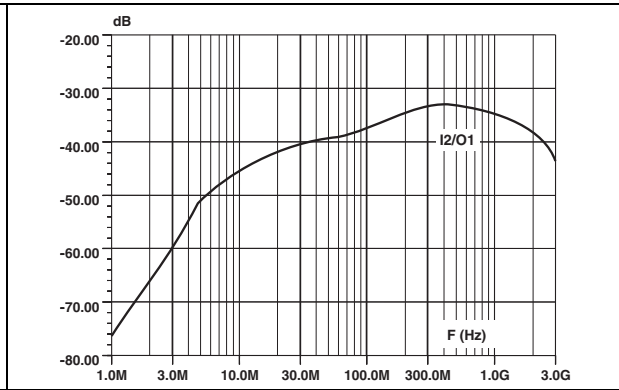

Figure 5. Digital crosstalk measurement

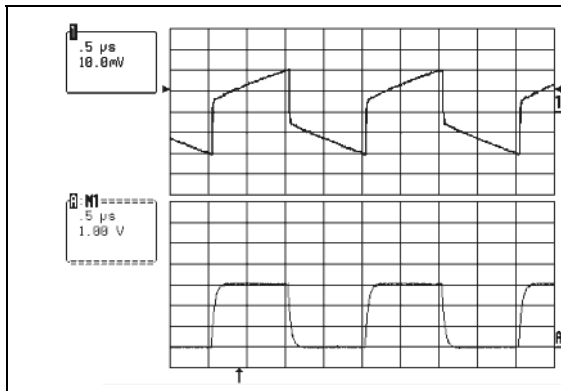

Figure 6. ESD response to IEC61000-4-2 (-15 kV air discharge) on one input V(in) and on one output V(out)

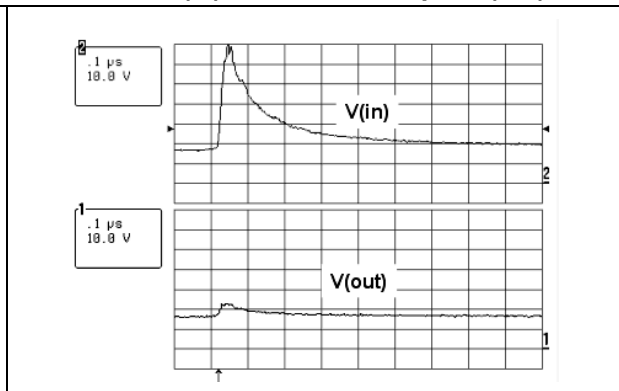

Figure 7. ESD response to IEC61000-4-2 (+15 kV air discharge) on one input V(in) and on one output V(out)

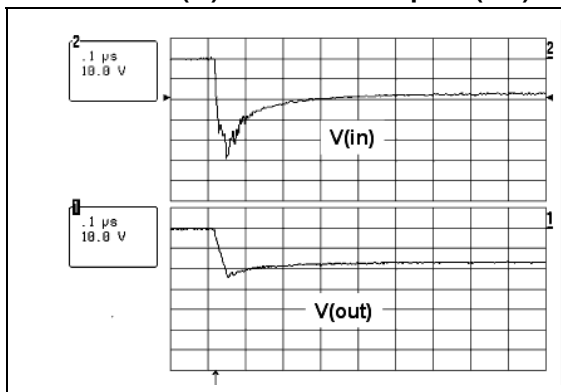
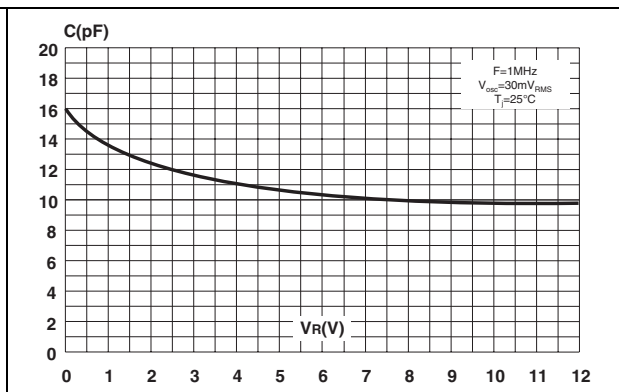

Figure 8. Line capacitance versus applied voltage



2 Application information

Figure 9. Aplac model

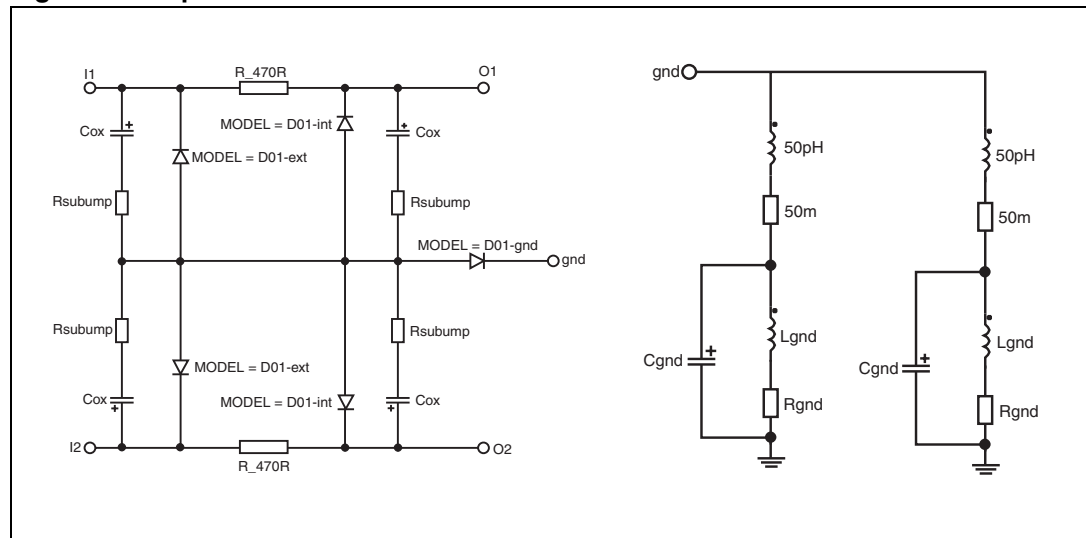
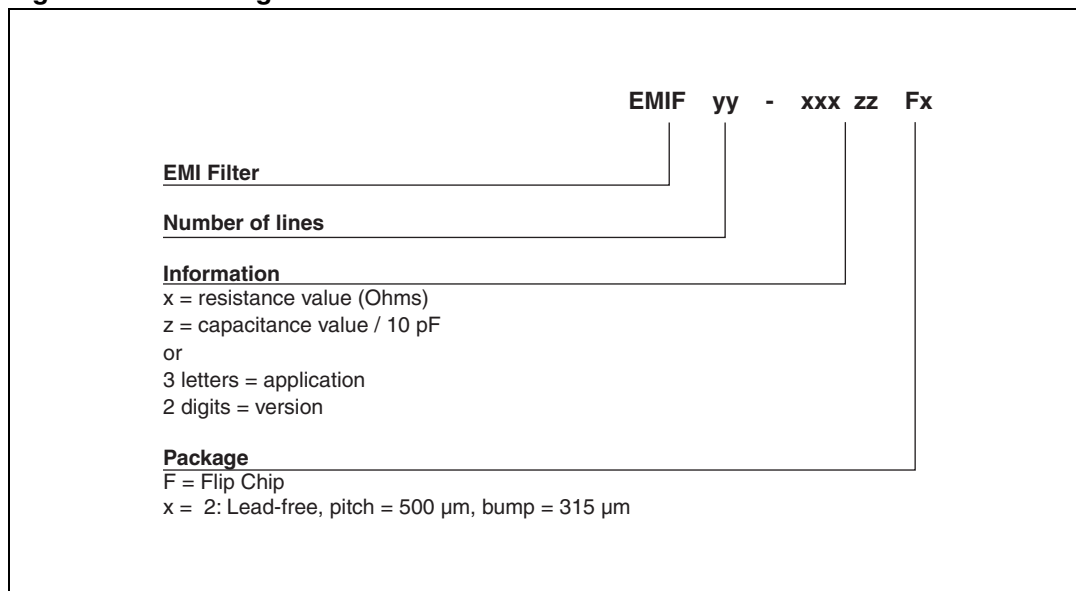

Figure 10. Aplac parameters

Model D01-ext	Model D01-int	Model D01-gnd	Ls 400pH
BV = 7	BV = 7	BV = 7	Rs 100m
CJO = Cz_ext	CJO = Cz_int	CJO = Cz_gnd	
IBV = 1u	IBV = 1u	IBV = 1u	R_470R 482.6
IKF = 1000	IKF = 1000	IKF = 1000	Cz_ext 8.73pF
IS = 10f	IS = 10f	IS = 10f	Rs_ext 850m
ISR = 100p	ISR = 100p	ISR = 100p	Cz_int 2.9pF
N = 1	N = 1	N = 1	Rs_int 850m
M = 0.3333	M = 0.3333	M = 0.3333	Cz_gnd 215.61pF
RS = Rs_ext	RS = Rs_int	RS = Rs_gnd	Rs_gnd 470m
VJ = 0.6	VJ = 0.6	VJ = 0.6	
TT = 50n	TT = 50n	TT = 50n	Rgnd 10m
			Lgnd 48pH
			Cgnd 0.15pF
			Cox 3.05pF
			Rsubump 200m

3 Ordering information scheme

Figure 11. Ordering information scheme



4 Package information

In order to meet environmental requirements, ST offers these devices in different grades of ECOPACK® packages, depending on their level of environmental compliance. ECOPACK® specifications, grade definitions and product status are available at: www.st.com. ECOPACK® is an ST trademark.

Figure 12. Package dimensions

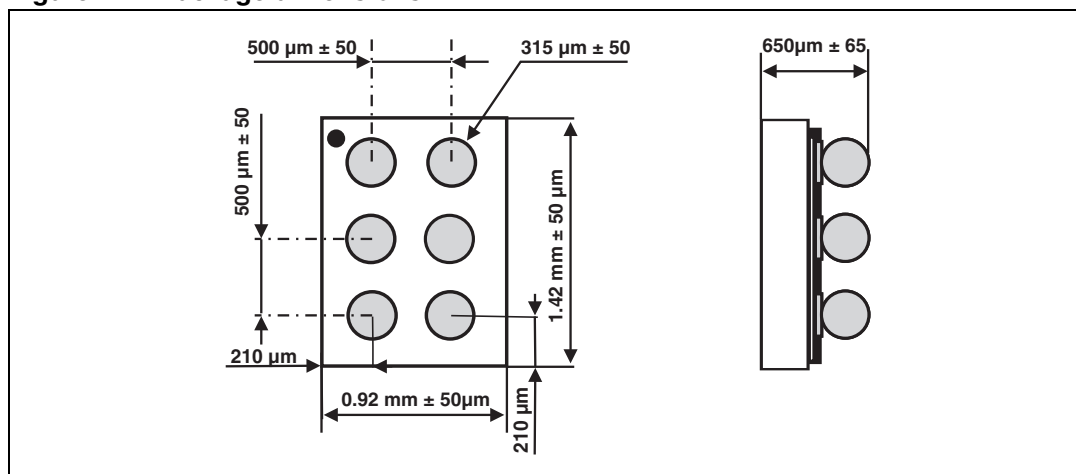

Figure 13. Footprint

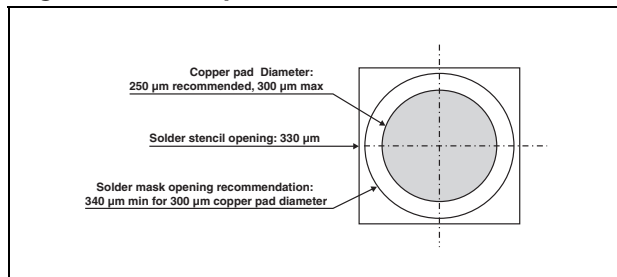

Figure 14. Marking

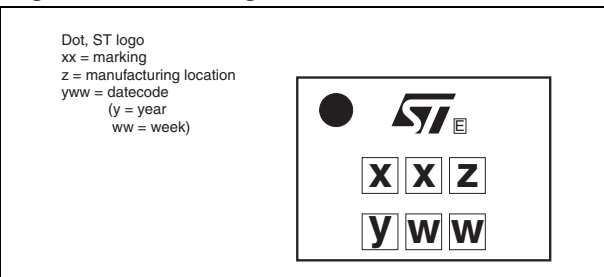
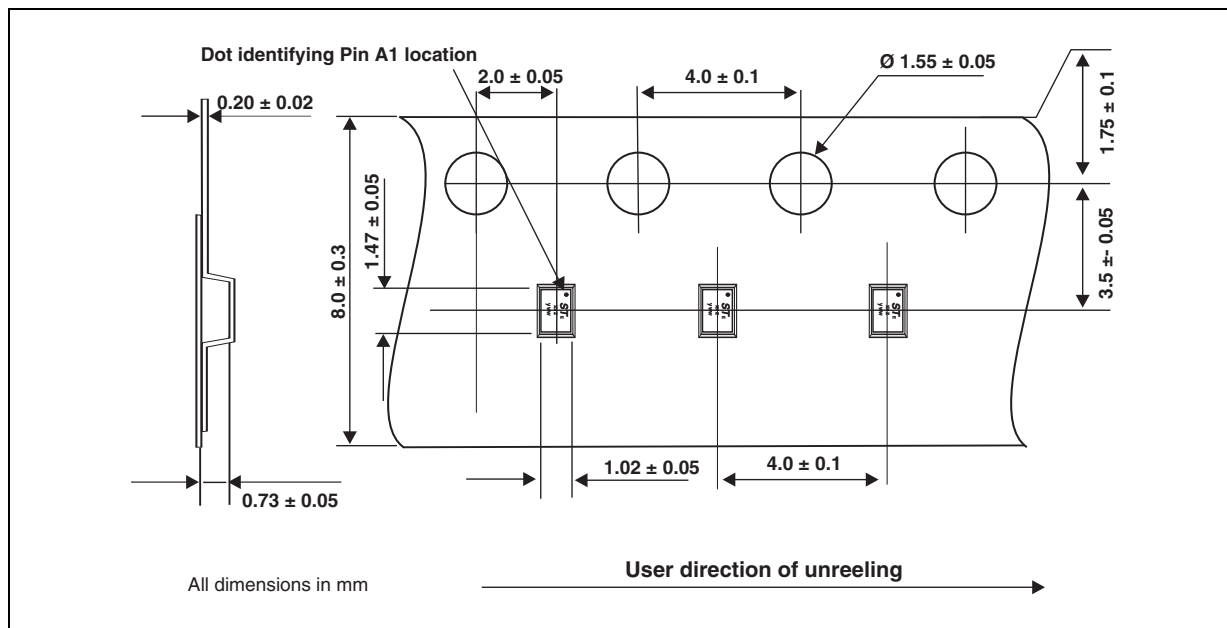

Figure 15. Flip Chip tape and reel specification



5 Ordering information

Table 3. Ordering information

Order code	Marking	Package	Weight	Base qty	Delivery mode
EMIF02-MIC02F2	FJ	Flip Chip	2.3 mg	5000	Tape and reel 7"

Note:

More information is available in the application notes:
AN1235: "Flip Chip: Package description and recommendations for use"
AN1751: "EMI filters: Recommendations and measurements"

6 Revision history

Table 4. Document revision history

Date	Revision	Changes
12-Oct-2004	1	Initial release.
11-Jan-2006	2	ECOPACK statement added. Die dimensions modified in Figure 12 . and first page. Typographical errors corrected.
17-Apr-2008	3	Updated ECOPACK statement. Updated Figure 11 , Figure 12 and Figure 15 . Reformatted to current standards.
26-May-2011	4	Updated C _{line} values in Table 2 .

Please Read Carefully:

Information in this document is provided solely in connection with ST products. STMicroelectronics NV and its subsidiaries ("ST") reserve the right to make changes, corrections, modifications or improvements, to this document, and the products and services described herein at any time, without notice.

All ST products are sold pursuant to ST's terms and conditions of sale.

Purchasers are solely responsible for the choice, selection and use of the ST products and services described herein, and ST assumes no liability whatsoever relating to the choice, selection or use of the ST products and services described herein.

No license, express or implied, by estoppel or otherwise, to any intellectual property rights is granted under this document. If any part of this document refers to any third party products or services it shall not be deemed a license grant by ST for the use of such third party products or services, or any intellectual property contained therein or considered as a warranty covering the use in any manner whatsoever of such third party products or services or any intellectual property contained therein.

UNLESS OTHERWISE SET FORTH IN ST'S TERMS AND CONDITIONS OF SALE ST DISCLAIMS ANY EXPRESS OR IMPLIED WARRANTY WITH RESPECT TO THE USE AND/OR SALE OF ST PRODUCTS INCLUDING WITHOUT LIMITATION IMPLIED WARRANTIES OF MERCHANTABILITY, FITNESS FOR A PARTICULAR PURPOSE (AND THEIR EQUIVALENTS UNDER THE LAWS OF ANY JURISDICTION), OR INFRINGEMENT OF ANY PATENT, COPYRIGHT OR OTHER INTELLECTUAL PROPERTY RIGHT.

UNLESS EXPRESSLY APPROVED IN WRITING BY AN AUTHORIZED ST REPRESENTATIVE, ST PRODUCTS ARE NOT RECOMMENDED, AUTHORIZED OR WARRANTED FOR USE IN MILITARY, AIR CRAFT, SPACE, LIFE SAVING, OR LIFE SUSTAINING APPLICATIONS, NOR IN PRODUCTS OR SYSTEMS WHERE FAILURE OR MALFUNCTION MAY RESULT IN PERSONAL INJURY, DEATH, OR SEVERE PROPERTY OR ENVIRONMENTAL DAMAGE. ST PRODUCTS WHICH ARE NOT SPECIFIED AS "AUTOMOTIVE GRADE" MAY ONLY BE USED IN AUTOMOTIVE APPLICATIONS AT USER'S OWN RISK.

Resale of ST products with provisions different from the statements and/or technical features set forth in this document shall immediately void any warranty granted by ST for the ST product or service described herein and shall not create or extend in any manner whatsoever, any liability of ST.

ST and the ST logo are trademarks or registered trademarks of ST in various countries.

Information in this document supersedes and replaces all information previously supplied.

The ST logo is a registered trademark of STMicroelectronics. All other names are the property of their respective owners.

© 2011 STMicroelectronics - All rights reserved

STMicroelectronics group of companies

Australia - Belgium - Brazil - Canada - China - Czech Republic - Finland - France - Germany - Hong Kong - India - Israel - Italy - Japan - Malaysia - Malta - Morocco - Philippines - Singapore - Spain - Sweden - Switzerland - United Kingdom - United States of America

www.st.com