



STTH1302CT/CG/CFP

HIGH EFFICIENCY ULTRAFAST DIODE

MAIN PRODUCT CHARACTERISTICS

$I_{F(AV)}$	2 x 6.5 A
V_{RRM}	200 V
T_j (max)	175 °C
V_F (max)	0.95 V
t_{rr} (max)	25 ns

FEATURES AND BENEFITS

- Suited for SMPS
- Low losses
- Low forward and reverse recovery times
- High surge current capability
- High junction temperature
- Insulated package: TO-220FPAB:
Insulation voltage = 2000 V_{DC}
Capacitance = 12 pF

DESCRIPTION

Dual center tap rectifier suited for Switch Mode Power Supplies and high frequency DC to DC converters.

This device is especially intended for use in low voltage, high frequency inverters, free wheeling and polarity protection applications.

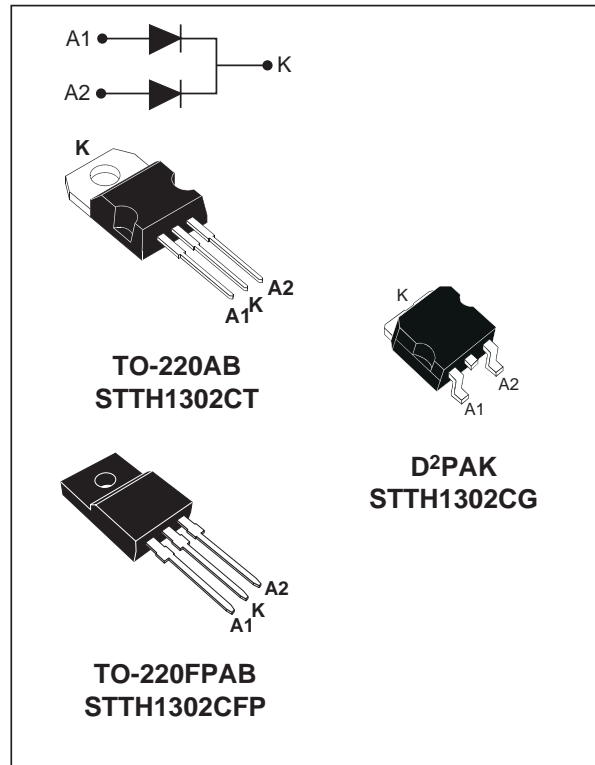

ABSOLUTE RATINGS (limiting values, per diode)

Symbol	Parameter			Value	Unit	
V_{RRM}	Repetitive peak reverse voltage			200	V	
$I_{F(RMS)}$	RMS forward current			20	A	
$I_{F(AV)}$	Average forward current $\delta = 0.5$	TO-220AB / D ² PAK	$T_c = 155^\circ\text{C}$	Per diode	6.5	A
			$T_c = 145^\circ\text{C}$	Per device	13	
		TO-220FPAB	$T_c = 135^\circ\text{C}$	Per diode	6.5	A
			$T_c = 110^\circ\text{C}$	Per device	13	
I_{FSM}	Surge non repetitive forward current		$t_p = 10$ ms	sinusoïdal	70	A
T_{stg}	Storage temperature range			-65 to +175	°C	
T_j	Maximum operating junction temperature			175	°C	

STTH1302CT/CG/CFP

THERMAL RESISTANCES

Symbol	Parameter		Value	Unit		
R _{th(j-c)}	Junction to case	TO-220AB / D ² PAK	Per diode	3	°C/W	
		TO-220FPAB		5.5		
		TO-220AB / D ² PAK	Total		1.9	°C/W
		TO-220FPAB			4.5	
R _{th(c)}	Coupling	TO-220AB / D ² PAK		0.8	°C/W	
		TO-220FPAB		3.5		

When the diodes 1 and 2 are used simultaneously :
 $\Delta T_j(\text{diode } 1) = P(\text{diode } 1) \times R_{th(j-c)}(\text{Per diode}) + P(\text{diode } 2) \times R_{th(c)}$

STATIC ELECTRICAL CHARACTERISTICS (per diode)

Symbol	Parameter	Tests Conditions		Min.	Typ.	Max.	Unit
I _R *	Reverse leakage Current	T _j = 25°C	V _R = V _{RRM}			6	μA
		T _j = 125°C			3	60	
V _F **	Forward Voltage drop	T _j = 25°C	I _F = 6.5 A			1.1	V
		T _j = 125°C	I _F = 6.5 A		0.81	0.95	
		T _j = 25°C	I _F = 13 A			1.25	
		T _j = 125°C	I _F = 13 A		0.95	1.1	

Pulse test : * t_p = 5 ms, δ < 2%
 ** t_p = 380 μs, δ < 2%

To evaluate the conduction losses use the following equation :

$$P = 0.80 \times I_{F(AV)} + 0.023 \times I_{F(RMS)}^2$$

DYNAMIC CHARACTERISTICS (per diode)

Symbol	Parameter	Test Conditions		Min.	Typ.	Max.	Unit
t _{rr}	Reverse recovery time	T _j = 25°C	I _F = 0.5 A I _{rr} = 0.25 A I _R = 1 A		16	25	ns
t _{fr}	Forward recovery time	T _j = 25°C	I _F = 6.5 A dI _F /dt = 100 A/μs V _{FR} = 1.1 x V _F max		70		ns
V _{FP}	Forward recovery voltage	T _j = 25°C	I _F = 6.5 A dI _F /dt = 100 A/μs		2.2		V

Fig. 1: Average forward power dissipation versus average forward current (per diode).

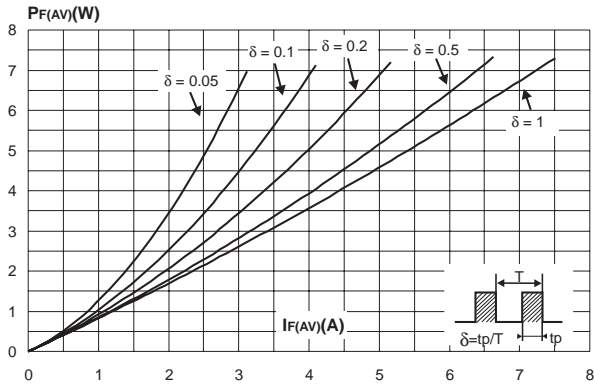

Fig. 2: Peak current versus factor (per diode).

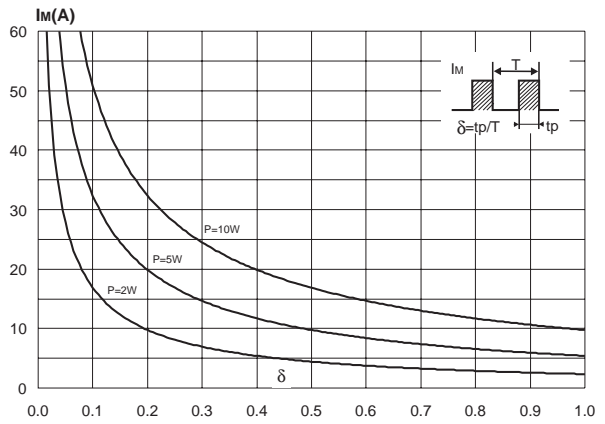

Fig. 3: Forward voltage drop versus forward current (per diode).

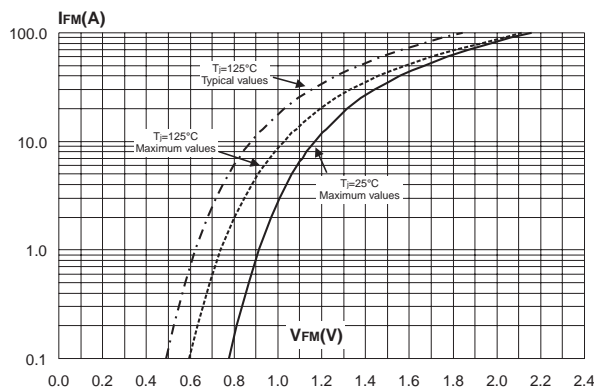

Fig. 4-1: Relative variation of thermal impedance junction to case versus pulse duration (TO-220AB / D²PAK).

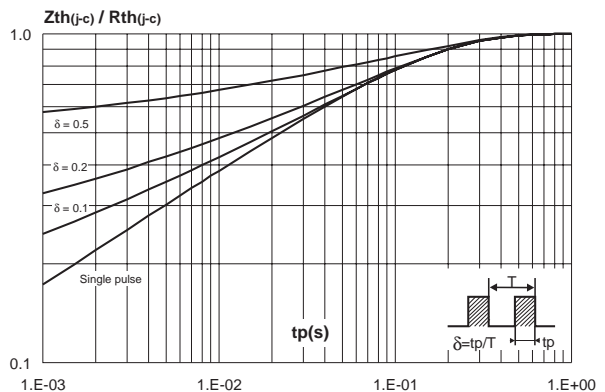

Fig. 4-2: Relative variation of thermal impedance junction to case versus pulse duration (TO-220FPAB).

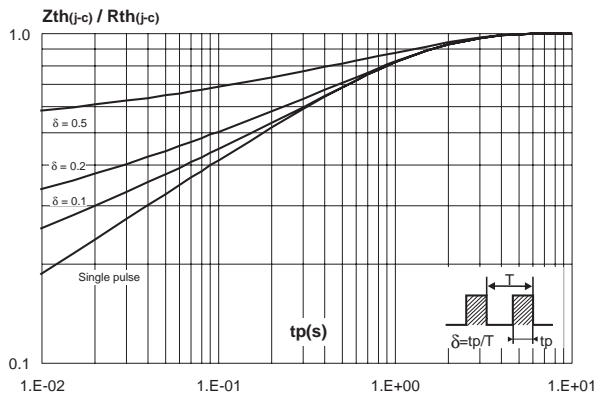

Fig. 5-1: Non repetitive surge peak forward current versus overload duration per diode (TO-220AB / D²PAK).

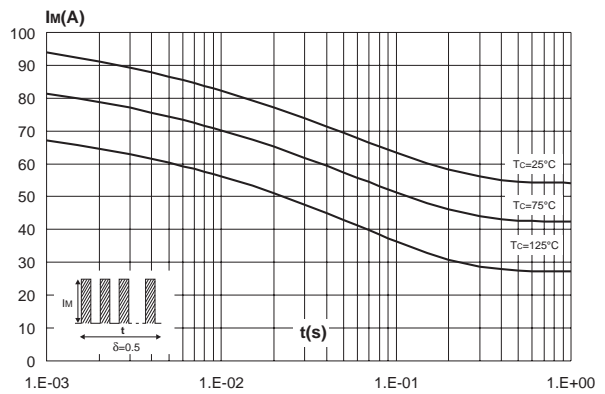

Fig. 5-2: Non repetitive surge peak forward current versus overload duration per diode (TO-220FPAB).

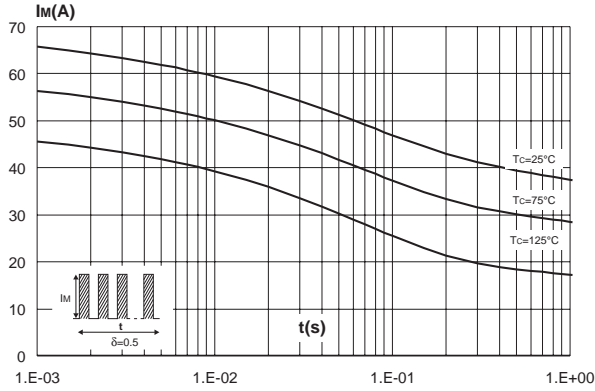

Fig. 6: Average forward current versus ambient temperature ($\delta=0.5$, per diode).

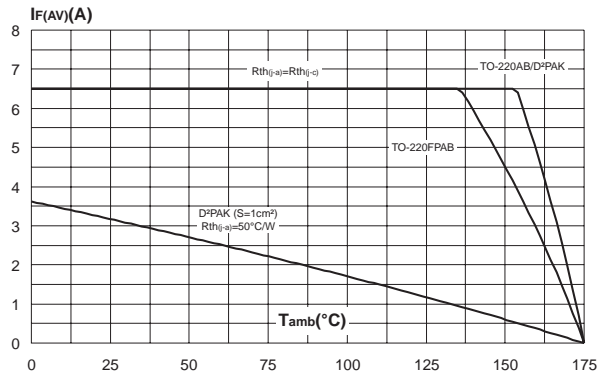

Fig. 7: Junction capacitance versus reverse voltage applied (typical values, per diode).

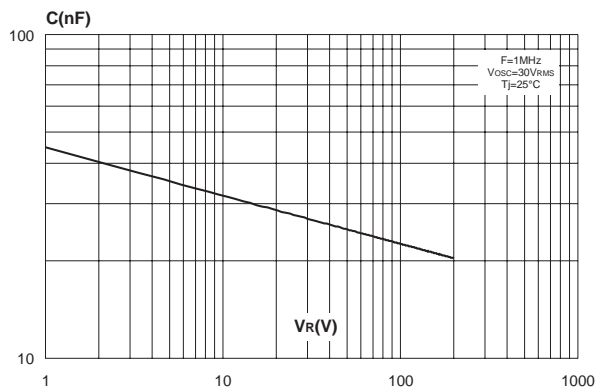

Fig. 8: Reverse recovery charges versus di_F/dt (90% confidence, per diode).

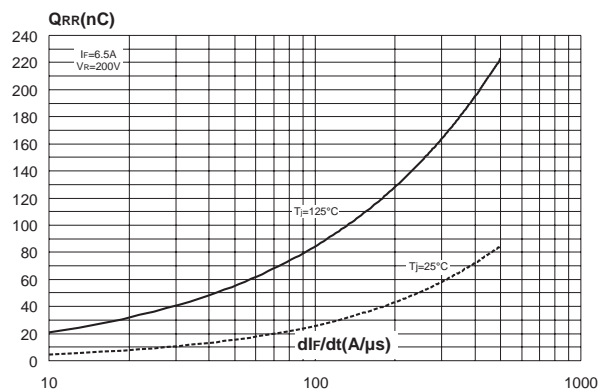

Fig. 9: Reverse recovery time versus di_F/dt (90% confidence, per diode).

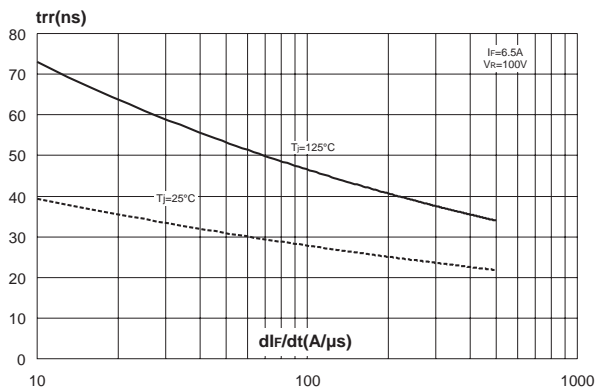

Fig. 10: Reverse recovery current versus di_F/dt (90% confidence, per diode).

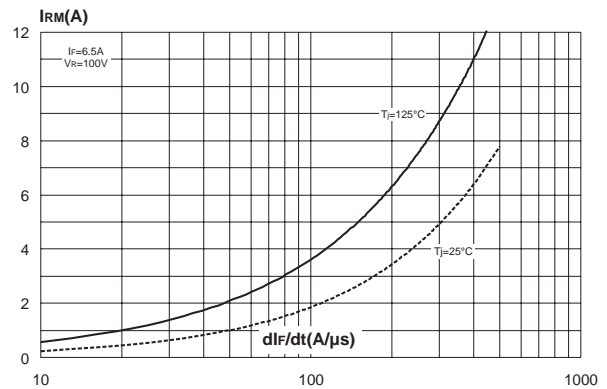

Fig. 11: Dynamic parameters versus junction temperature.

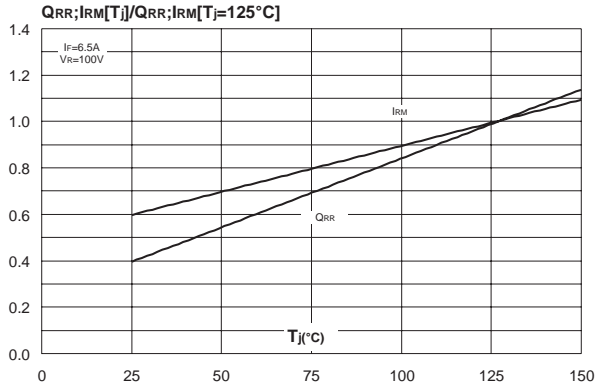
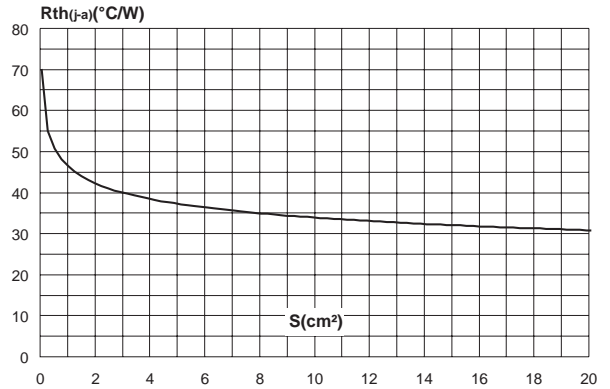
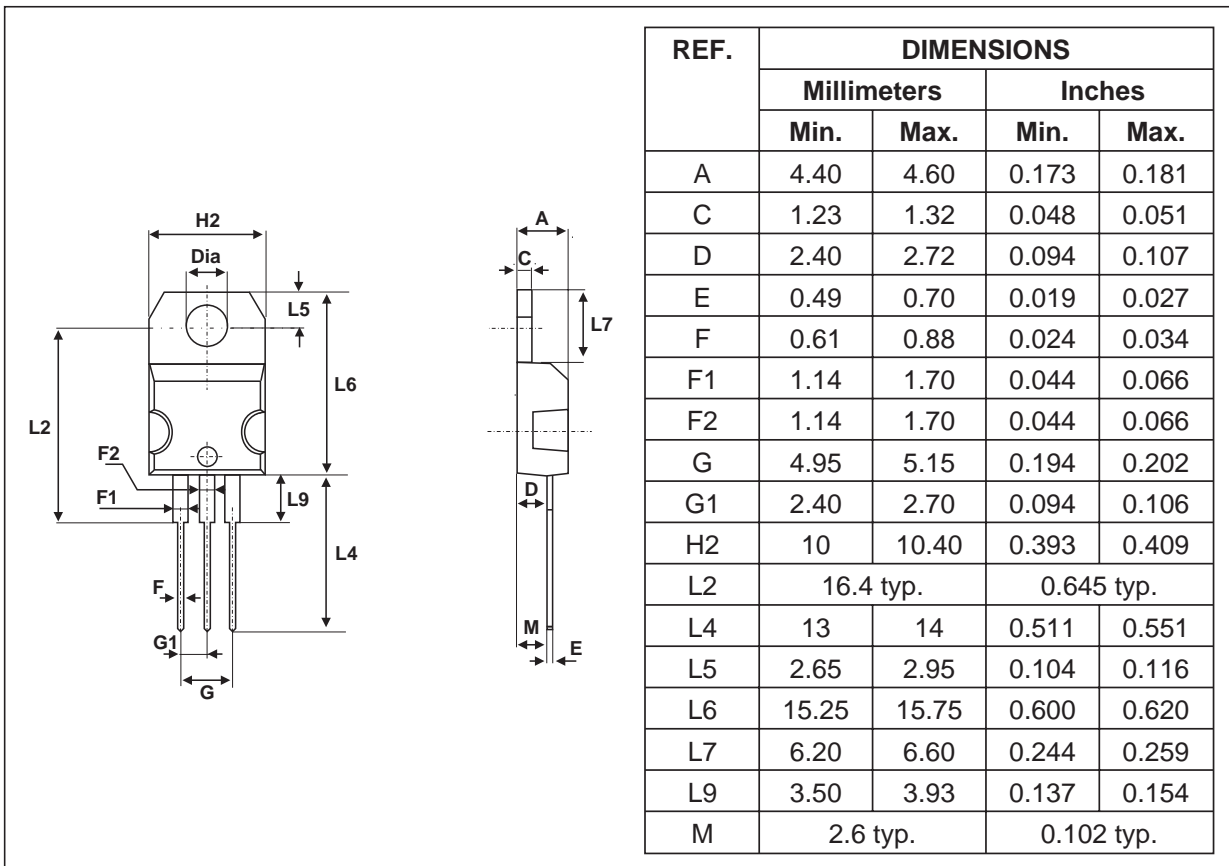

Fig. 12: Thermal resistance junction to ambient versus copper surface under tab (epoxy printed board FR4, Cu = 35µm)(D²PAK).



PACKAGE MECHANICAL DATA
TO-220AB



PACKAGE MECHANICAL DATA
D²PAK

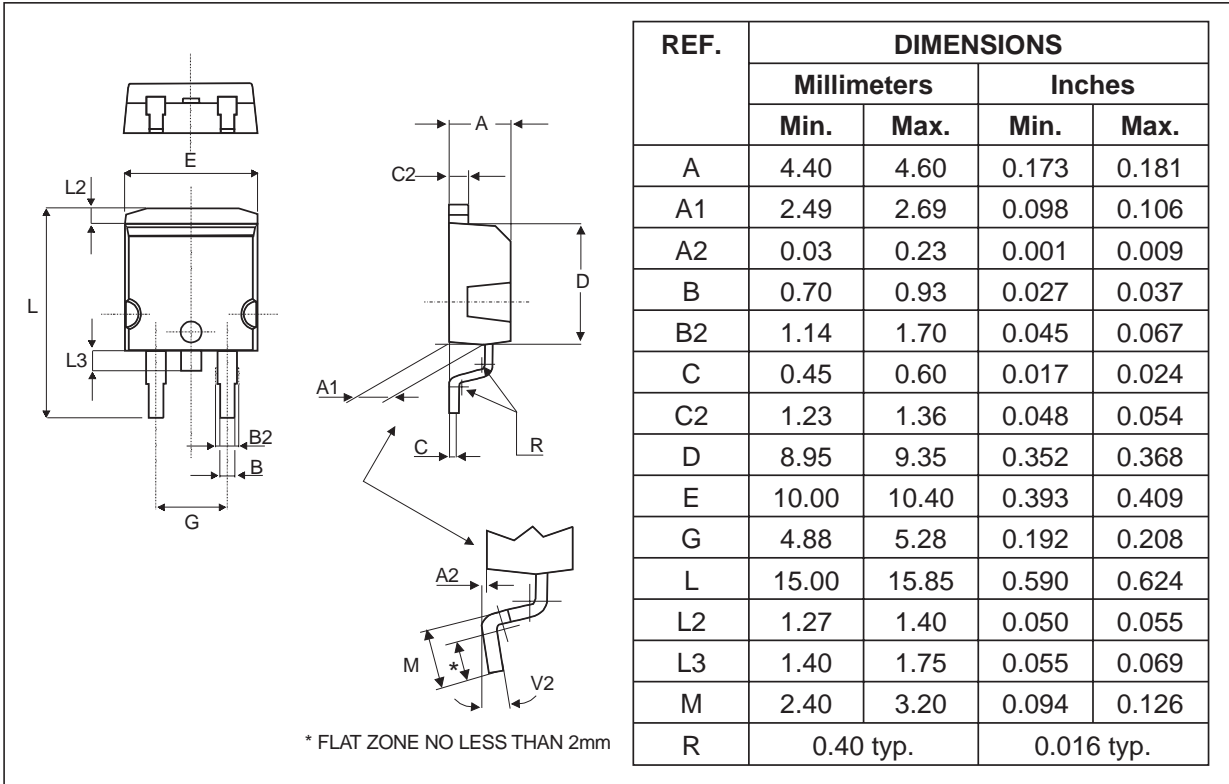

FOOTPRINT

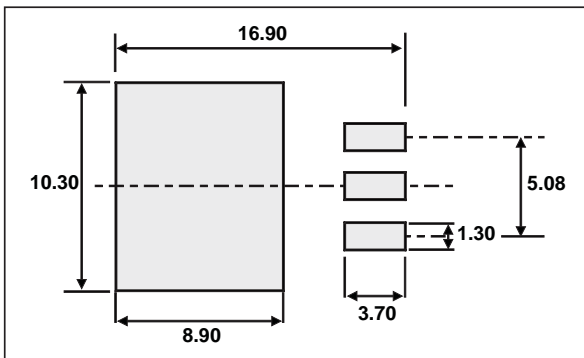

PACKAGE MECHANICAL DATA

TO-220FPAB

REF.	DIMENSIONS			
	Millimeters		Inches	
	Min.	Max.	Min.	Max.
A	4.4	4.6	0.173	0.181
B	2.5	2.7	0.098	0.106
D	2.5	2.75	0.098	0.108
E	0.45	0.70	0.018	0.027
F	0.75	1	0.030	0.039
F1	1.15	1.70	0.045	0.067
F2	1.15	1.70	0.045	0.067
G	4.95	5.20	0.195	0.205
G1	2.4	2.7	0.094	0.106
H	10	10.4	0.393	0.409
L2	16 Typ.		0.63 Typ.	
L3	28.6	30.6	1.126	1.205
L4	9.8	10.6	0.386	0.417
L5	2.9	3.6	0.114	0.142
L6	15.9	16.4	0.626	0.646
L7	9.00	9.30	0.354	0.366
Dia.	3.00	3.20	0.118	0.126

Ordering type	Marking	Package	Weight	Base qty	Delivery mode
STTH1302CT	STTH1302CT	TO-220AB	2.20 g	50	Tube
STTH1302CFP	STTH1302CFP	TO-220FPAB	2.0 g	50	Tube
STTH1302CG	STTH1302CG	D ² PAK	1.48 g	50	Tube
STTH1302CG-TR	STTH1302CG	D ² PAK	1.48 g	1000	Tape & reel

- Epoxy meets UL94,V0

Information furnished is believed to be accurate and reliable. However, STMicroelectronics assumes no responsibility for the consequences of use of such information nor for any infringement of patents or other rights of third parties which may result from its use. No license is granted by implication or otherwise under any patent or patent rights of STMicroelectronics. Specifications mentioned in this publication are subject to change without notice. This publication supersedes and replaces all information previously supplied. STMicroelectronics products are not authorized for use as critical components in life support devices or systems without express written approval of STMicroelectronics.

The ST logo is a registered trademark of STMicroelectronics.

All other names are the property of their respective owners.

© 2003 STMicroelectronics - All rights reserved.

STMicroelectronics GROUP OF COMPANIES

Australia - Belgium - Brazil - Canada - China - Czech Republic - Finland - France - Germany -
Hong Kong - India - Israel - Italy - Japan - Malaysia - Malta - Morocco - Singapore - Spain -
Sweden - Switzerland - United Kingdom - United States

www.st.com

