



# STTH8R03G/D

## 300V HYPERFAST RECTIFIER

### MAJOR PRODUCT CHARACTERISTICS

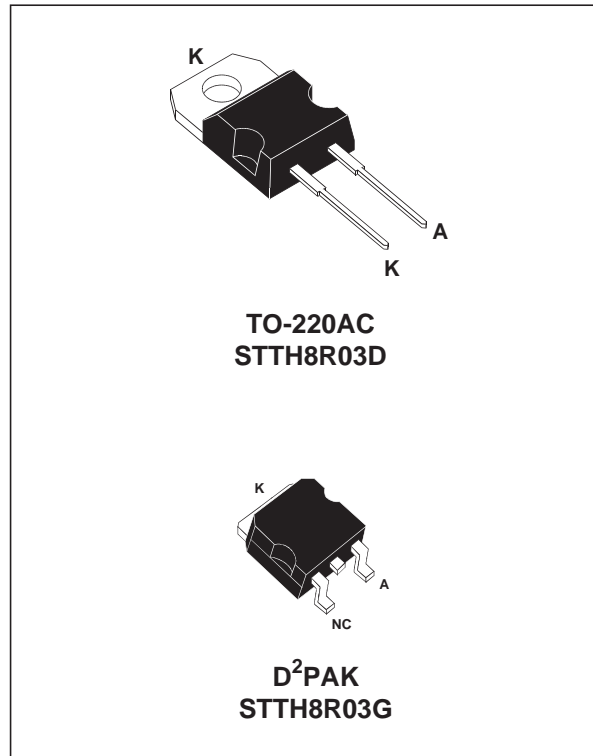
|                 |        |
|-----------------|--------|
| $I_{F(AV)}$     | 8 A    |
| $V_{RRM}$       | 300 V  |
| $I_{RM}$ (typ.) | 4A     |
| $T_j$ (max)     | 175 °C |
| $V_F$ (max)     | 1.3 V  |
| $t_{rr}$ (max)  | 30 ns  |

### FEATURES AND BENEFITS

- Designed for high frequency applications.
- Hyperfast recovery competes with GaAs devices.
- Allows size decrease of snubbers and heatsinks.

### DESCRIPTION

The TURBOSWITCH "R" is an ultra high performance diode.  
This TURBOSWITCH family, which drastically cuts losses in associated MOSFET when run at high  $dI_F/dt$ , is suited for HF OFF-Line SMPS and DC/DC converters.



### ABSOLUTE RATINGS (limiting values, per diode)

| Symbol       | Parameter                              |                                              | Value      | Unit |
|--------------|----------------------------------------|----------------------------------------------|------------|------|
| $V_{RRM}$    | Repetitive peak reverse voltage        |                                              | 300        | V    |
| $I_{F(RMS)}$ | RMS forward current                    |                                              | 20         | A    |
| $I_{F(AV)}$  | Average forward current                | $T_c = 140^\circ\text{C} \quad \delta = 0.5$ | 8          | A    |
| $I_{FSM}$    | Surge non repetitive forward current   | $t_p = 10 \text{ ms sinusoidal}$             | 80         | A    |
| $T_{stg}$    | Storage temperature range              |                                              | - 65 + 175 | °C   |
| $T_j$        | Maximum operating junction temperature |                                              | + 175      | °C   |

## STTH8R03G/D

### THERMAL AND POWER DATA

| Symbol        | Parameter        | Value | Unit |
|---------------|------------------|-------|------|
| $R_{th(j-c)}$ | Junction to case | 2.5   | °C/W |

### STATIC ELECTRICAL CHARACTERISTICS

| Symbol     | Parameter               | Tests conditions   | Min.                      | Typ. | Max. | Unit |               |
|------------|-------------------------|--------------------|---------------------------|------|------|------|---------------|
| $I_R^*$    | Reverse leakage current | $V_R = V_{RRM}$    | $T_j = 25^\circ\text{C}$  |      |      | 10   | $\mu\text{A}$ |
|            |                         |                    | $T_j = 125^\circ\text{C}$ |      | 15   | 100  |               |
| $V_F^{**}$ | Forward voltage drop    | $I_F = 8\text{ A}$ | $T_j = 25^\circ\text{C}$  |      |      | 1.8  | V             |
|            |                         |                    | $T_j = 125^\circ\text{C}$ |      | 1.05 | 1.3  |               |

Pulse test : \*  $t_p = 5\text{ ms}$ ,  $\delta < 2\%$

\*\*  $t_p = 380\text{ }\mu\text{s}$ ,  $\delta < 2\%$

To evaluate the maximum conduction losses use the following equation :

$$P = 0.9 \times I_{F(AV)} + 0.05 I_{F(RMS)}^2$$

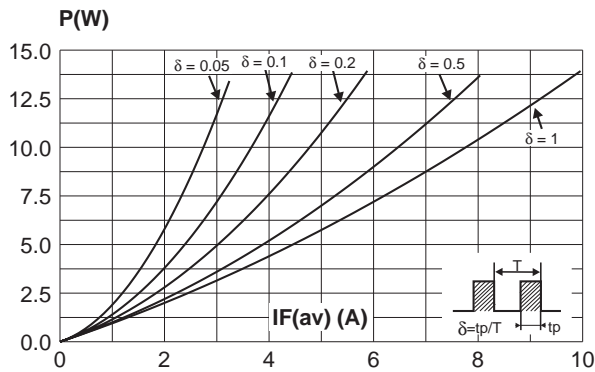
### RECOVERY CHARACTERISTICS

| Symbol   | Tests conditions                                                              | Min. | Typ. | Max. | Unit |
|----------|-------------------------------------------------------------------------------|------|------|------|------|
| $t_{rr}$ | $I_F = 0.5\text{ A}$ $I_{rr} = 0.25\text{ A}$ $I_R = 1\text{ A}$              |      | 13   | 30   | ns   |
|          | $I_F = 1\text{ A}$ $dI_F/dt = -50\text{ A}/\mu\text{s}$ $V_R = 30\text{ V}$   |      |      |      |      |
| $I_{RM}$ | $V_R = 200\text{ V}$ $I_F = 8\text{ A}$ $dI_F/dt = -200\text{ A}/\mu\text{s}$ |      | 4    | 5.5  | A    |
| S factor |                                                                               |      | 0.4  |      |      |

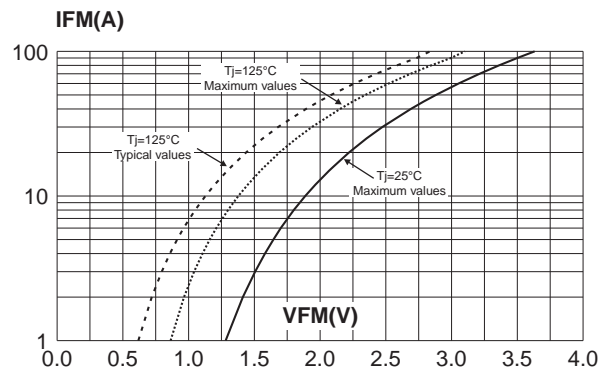
### TURN-ON SWITCHING CHARACTERISTICS

| Symbol   | Tests conditions                                                                                                      | Min. | Typ. | Max. | Unit |
|----------|-----------------------------------------------------------------------------------------------------------------------|------|------|------|------|
| $t_{tr}$ | $T_j = 25^\circ\text{C}$ $I_F = 8\text{ A}$ $dI_F/dt = 100\text{ A}/\mu\text{s}$<br>measured at $1.1 \times V_{Fmax}$ |      |      | 200  | ns   |
| $V_{FP}$ | $T_j = 25^\circ\text{C}$ $I_F = 8\text{ A}$ $dI_F/dt = 100\text{ A}/\mu\text{s}$                                      |      |      | 3.5  | V    |

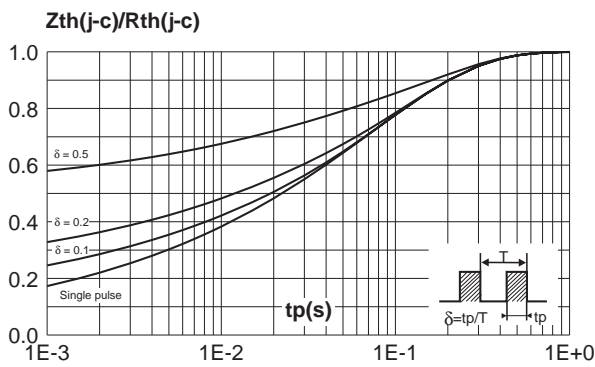
**Fig. 1:** Conduction losses versus average current



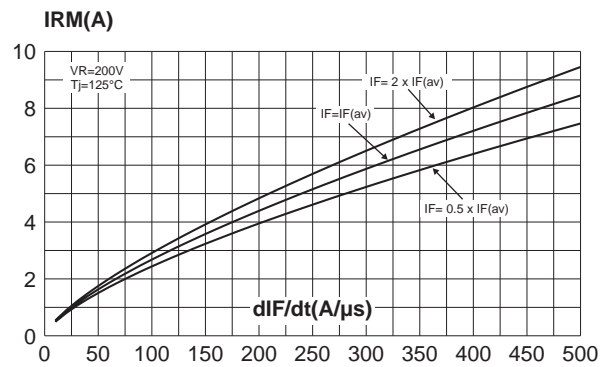
**Fig. 2:** Forward voltage drop versus forward current



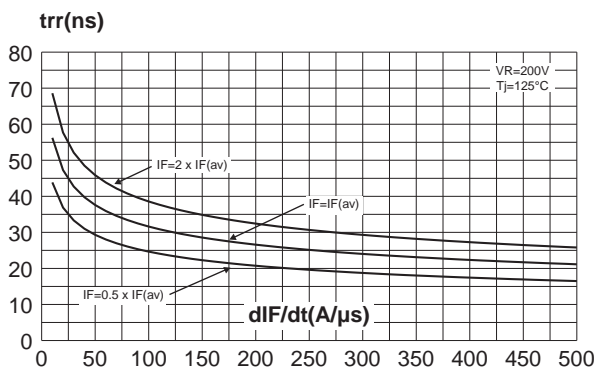
**Fig. 3:** Relative variation of thermal impedance junction to case versus pulse duration



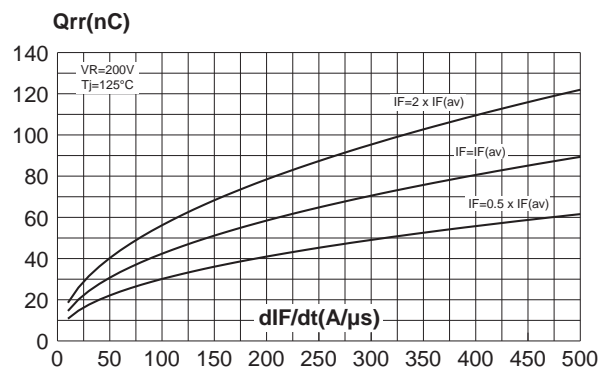
**Fig. 4:** Peak reverse recovery current versus dIF/dt (90% confidence)



**Fig. 5:** Reverse recovery time versus dIF/dt (90% confidence)

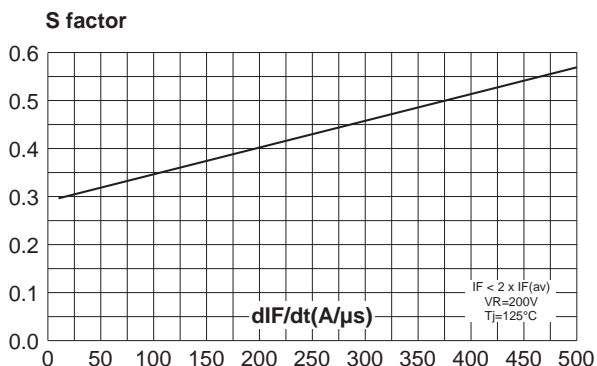


**Fig. 6:** Reverse recovery charges versus dIF/dt (90% confidence)

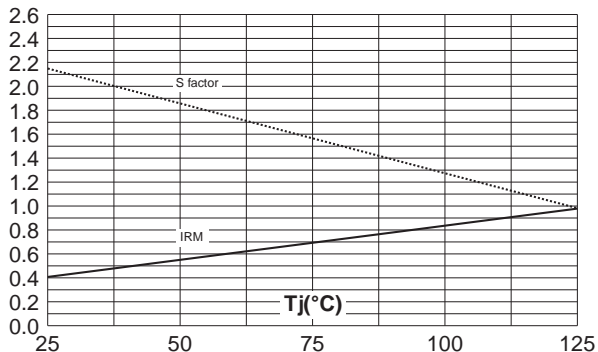


# STTH8R03G/D

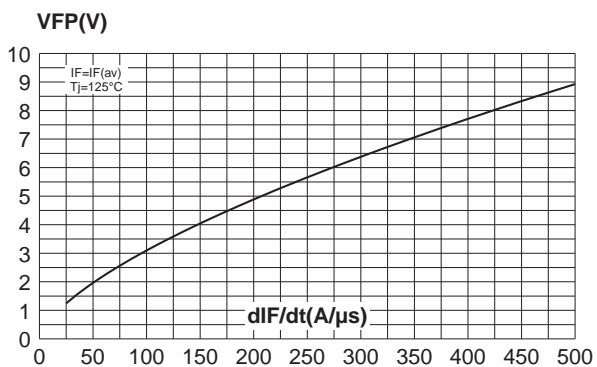
**Fig. 7:** Softness factor (tb/ta) versus dIF/dt (typical values).



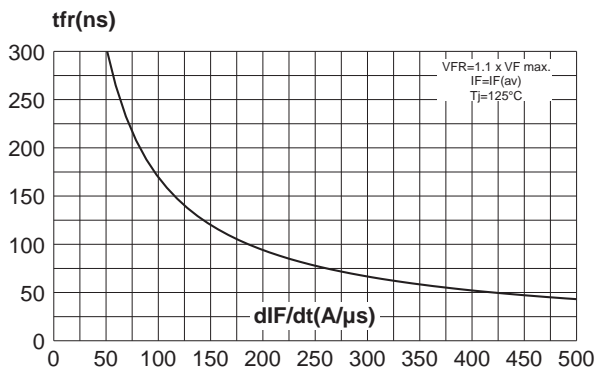
**Fig. 8:** Relative variation of dynamic parameters versus junction temperature (Reference: Tj=125°C).



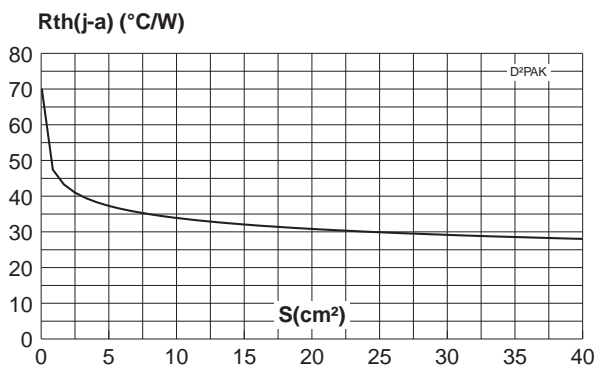
**Fig. 9:** Transient peak forward voltage versus dIF/dt (90% confidence).



**Fig. 10:** Forward recovery time versus dIF/dt (90% confidence).

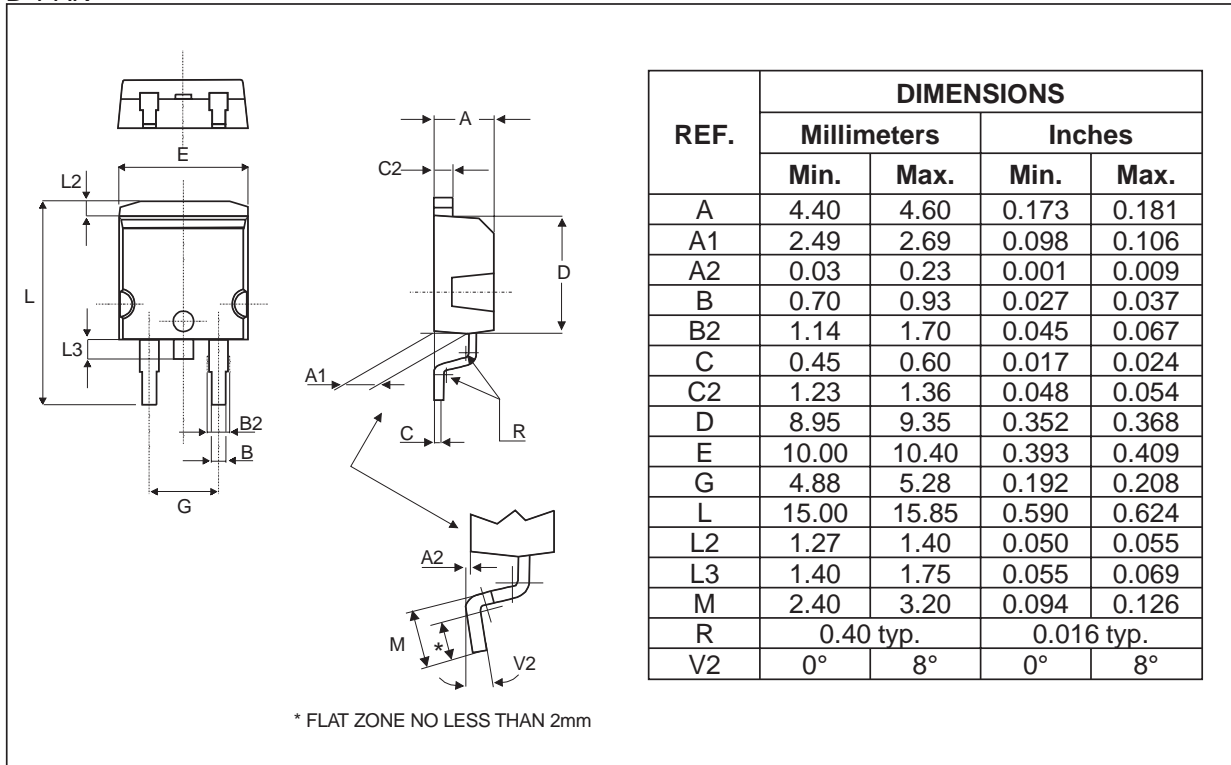


**Fig. 11:** Thermal resistance junction to ambient versus copper surface under tab (Epoxy printed circuit board FR4, copper thickness: 35μm)(D<sup>2</sup>PAK)

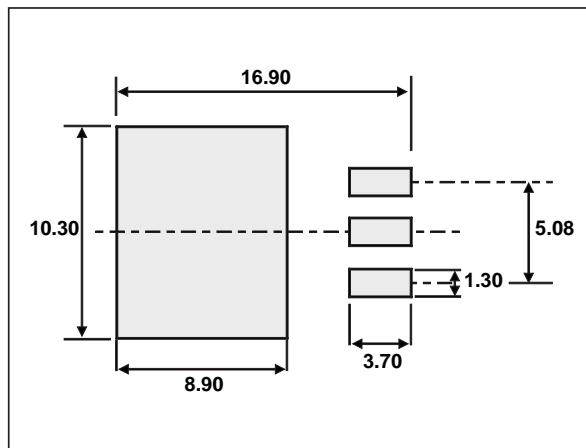


PACKAGE MECHANICAL DATA

D<sup>2</sup>PAK



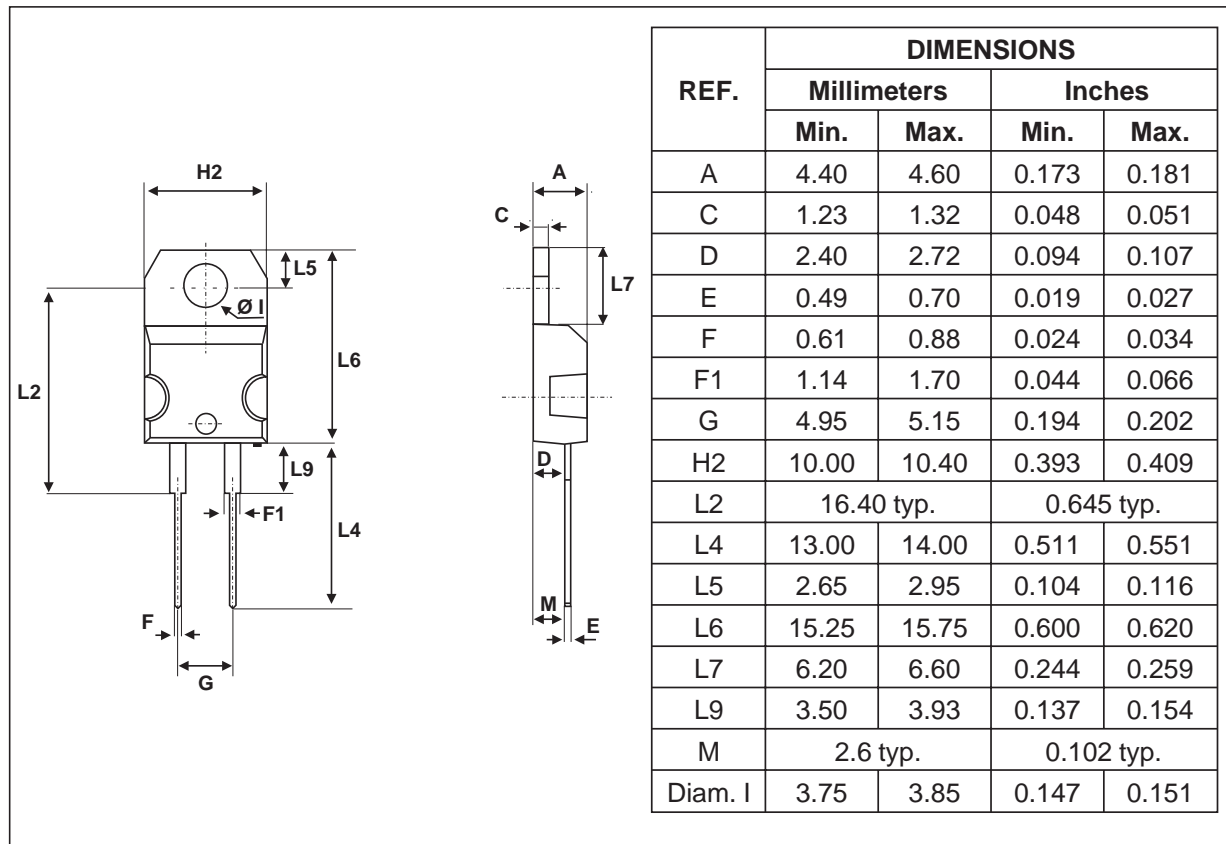
FOOTPRINT



# STTH8R03G/D

## PACKAGE MECHANICAL DATA

TO-220AC



| Ordering code | Marking   | Package            | Weight | Base qty | Delivery mode |
|---------------|-----------|--------------------|--------|----------|---------------|
| STTH8R03D     | STTH8R03D | TO-220AC           | 1.86g  | 50       | Tube          |
| STTH8R03G     | STTH8R03G | D <sup>2</sup> PAK | 1.48g  | 50       | Tube          |
| STTH8R03G-TR  | STTH8R03G | D <sup>2</sup> PAK | 1.48g  | 1000     | Tape & Reel   |

- Cooling method: by conduction (C)
- Recommended torque value (TO-220AC): 0.55 N.m.
- Maximum torque value (TO-220AC): 0.7 N.m.
- Epoxy meets UL 94,V0

Information furnished is believed to be accurate and reliable. However, STMicroelectronics assumes no responsibility for the consequences of use of such information nor for any infringement of patents or other rights of third parties which may result from its use. No license is granted by implication or otherwise under any patent or patent rights of STMicroelectronics. Specifications mentioned in this publication are subject to change without notice. This publication supersedes and replaces all information previously supplied. STMicroelectronics products are not authorized for use as critical components in life support devices or systems without express written approval of STMicroelectronics.

The ST logo is a registered trademark of STMicroelectronics

© 2001 STMicroelectronics - Printed in Italy - All rights reserved.

STMicroelectronics GROUP OF COMPANIES

Australia - Brazil - China - Finland - France - Germany - Hong Kong - India - Italy - Japan - Malaysia  
Malta - Morocco - Singapore - Spain - Sweden - Switzerland - United Kingdom - U.S.A.

<http://www.st.com>