



# STPS20L15D/G

## LOW DROP OR-ing POWER SCHOTTKY DIODE

### MAIN PRODUCT CHARACTERISTICS

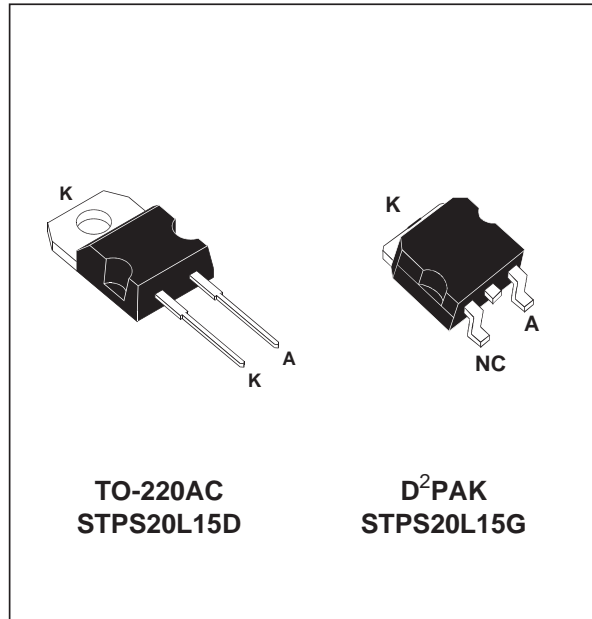
$I_{F(AV)}$	20 A
$V_{RRM}$	15 V
$T_j(\text{max})$	125°C
$V_F(\text{max})$	0.33 V

### FEATURES AND BENEFITS

- VERY LOW FORWARD VOLTAGE DROP FOR LESS POWER DISSIPATION AND REDUCED HEATSINK SIZE
- REVERSE VOLTAGE SUITED TO OR-ing OF 3V, 5V and 12V RAILS
- AVALANCHE CAPABILITY SPECIFIED

### DESCRIPTION

Packaged in TO-220AC or D<sup>2</sup>PAK, this device is especially intended for use as an OR-ing diode in fault tolerant power supply equipments.



### ABSOLUTE RATINGS (limiting values)

Symbol	Parameter		Value	Unit
$V_{RRM}$	Repetitive peak reverse voltage		15	V
$I_{F(RMS)}$	RMS forward current		30	A
$I_{F(AV)}$	Average forward current	$T_c = 115^\circ\text{C} \quad \delta = 1$	20	A
$I_{FSM}$	Surge non repetitive forward current	$t_p = 10 \text{ ms}$ Sinusoidal	310	A
$I_{RRM}$	Repetitive peak reverse current	$t_p = 2 \mu\text{s}$ $F = 1 \text{ kHz}$	2	A
$I_{RSM}$	Non repetitive peak reverse current	$t_p = 100 \mu\text{s}$	3	A
$P_{ARM}$	Repetitive peak avalanche power	$t_p = 1 \mu\text{s}$ $T_j = 25^\circ\text{C}$	13500	W
$T_{stg}$	Storage temperature range		- 65 to + 150	°C
$T_j$	Maximum operating junction temperature *		125	°C
$dV/dt$	Critical rate of rise of reverse voltage		10000	V/ $\mu\text{s}$

\* :  $\frac{dP_{tot}}{dT_j} < \frac{1}{R_{th(j-a)}}$  thermal runaway condition for a diode on its own heatsink

### THERMAL RESISTANCES

Symbol	Parameter	Value	Unit
$R_{th(j-c)}$	Junction to case	1.6	°C/W

# STPS20L15D/G

## STATIC ELECTRICAL CHARACTERISTICS

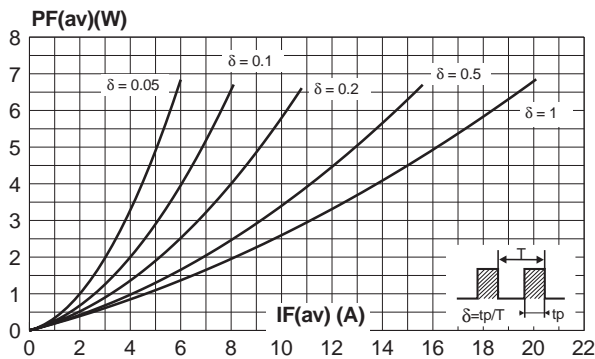
Symbol	Tests Conditions	Tests Conditions	Min.	Typ.	Max.	Unit	
$I_R^*$	Reverse leakage current	$T_j = 25^\circ\text{C}$	$V_R = 15\text{V}$			6	mA
		$T_j = 100^\circ\text{C}$	$V_R = 15\text{V}$		200		
$V_F^*$	Forward voltage drop	$T_j = 25^\circ\text{C}$	$I_F = 19\text{A}$			0.41	V
		$T_j = 25^\circ\text{C}$	$I_F = 40\text{A}$			0.52	
		$T_j = 125^\circ\text{C}$	$I_F = 19\text{A}$		0.28	0.33	
		$T_j = 125^\circ\text{C}$	$I_F = 40\text{A}$		0.42	0.50	

Pulse test : \*  $t_p = 380\ \mu\text{s}$ ,  $\delta < 2\%$

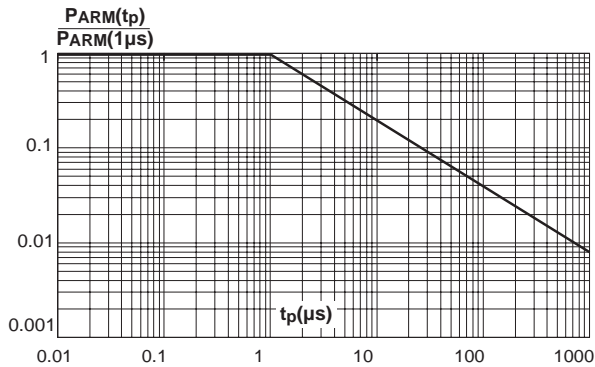
To evaluate the maximum conduction losses use the following equation :

$$P = 0.18 \times I_{F(AV)} + 8.10^{-3} \times I_{F(RMS)}^2$$

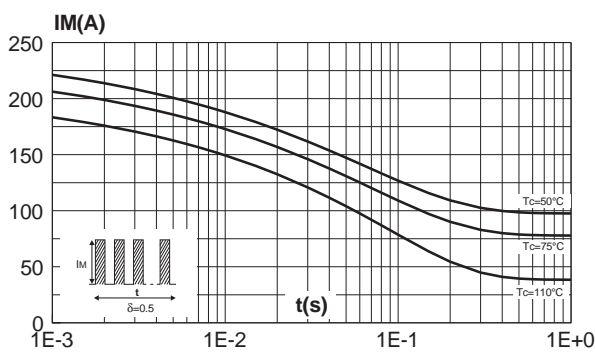
**Fig. 1:** Average forward power dissipation versus average forward current.



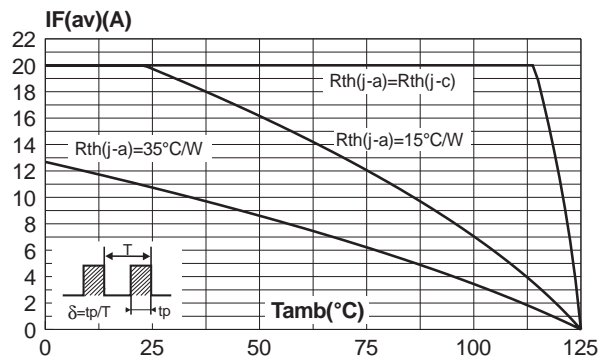
**Fig. 3:** Normalized avalanche power derating versus pulse duration.



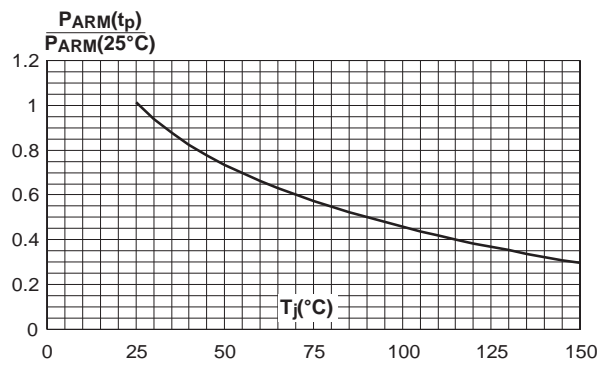
**Fig. 5:** Non repetitive surge peak forward current versus overload duration (maximum values).



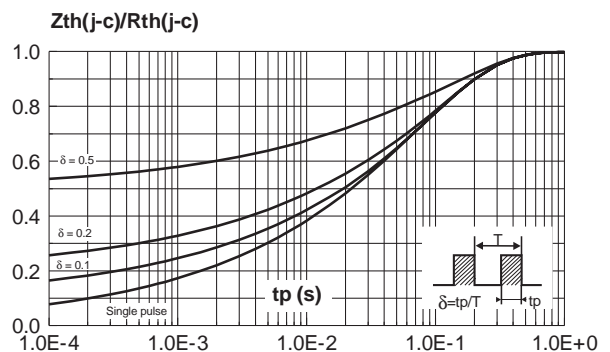
**Fig. 2:** Average forward current versus ambient temperature ( $\delta = 1$ ).



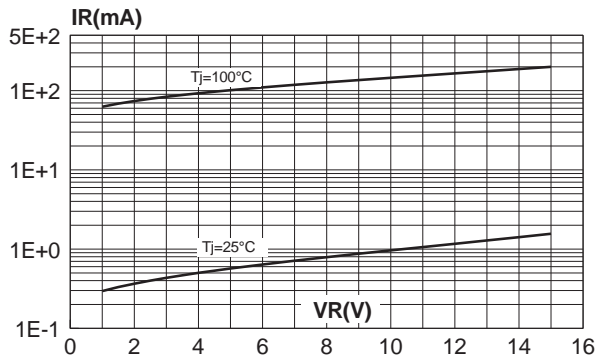
**Fig. 4:** Normalized avalanche power derating versus junction temperature.



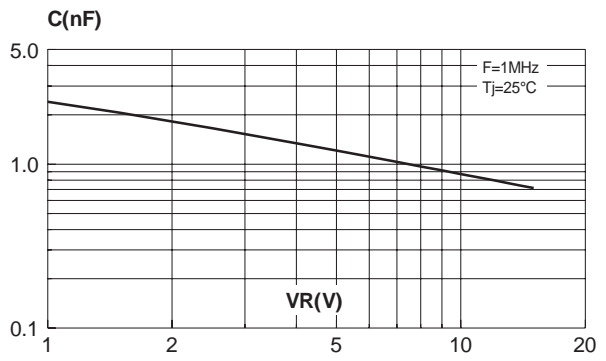
**Fig. 6:** Relative variation of thermal impedance junction to case versus pulse duration.



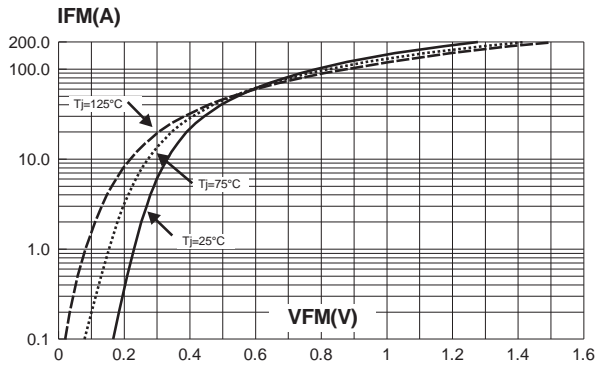
**Fig. 7:** Reverse leakage current versus reverse voltage applied (typical values).



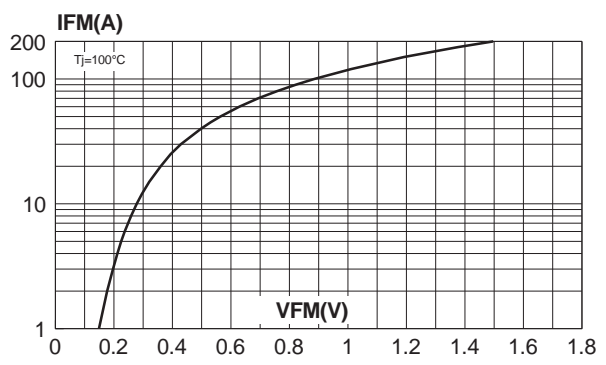
**Fig. 8:** Junction capacitance versus reverse voltage applied (typical values).



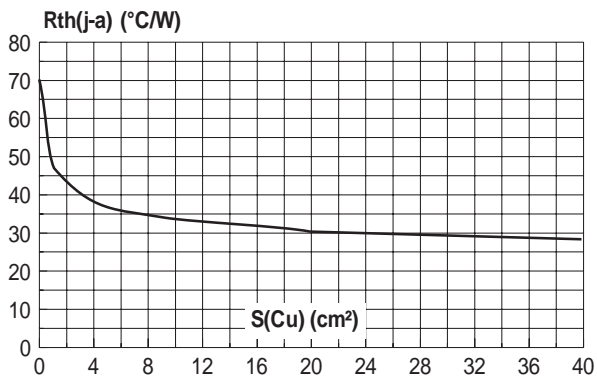
**Fig. 9:** Forward voltage drop versus forward current (typical values).



**Fig. 10:** Forward voltage drop versus forward current (maximum values).

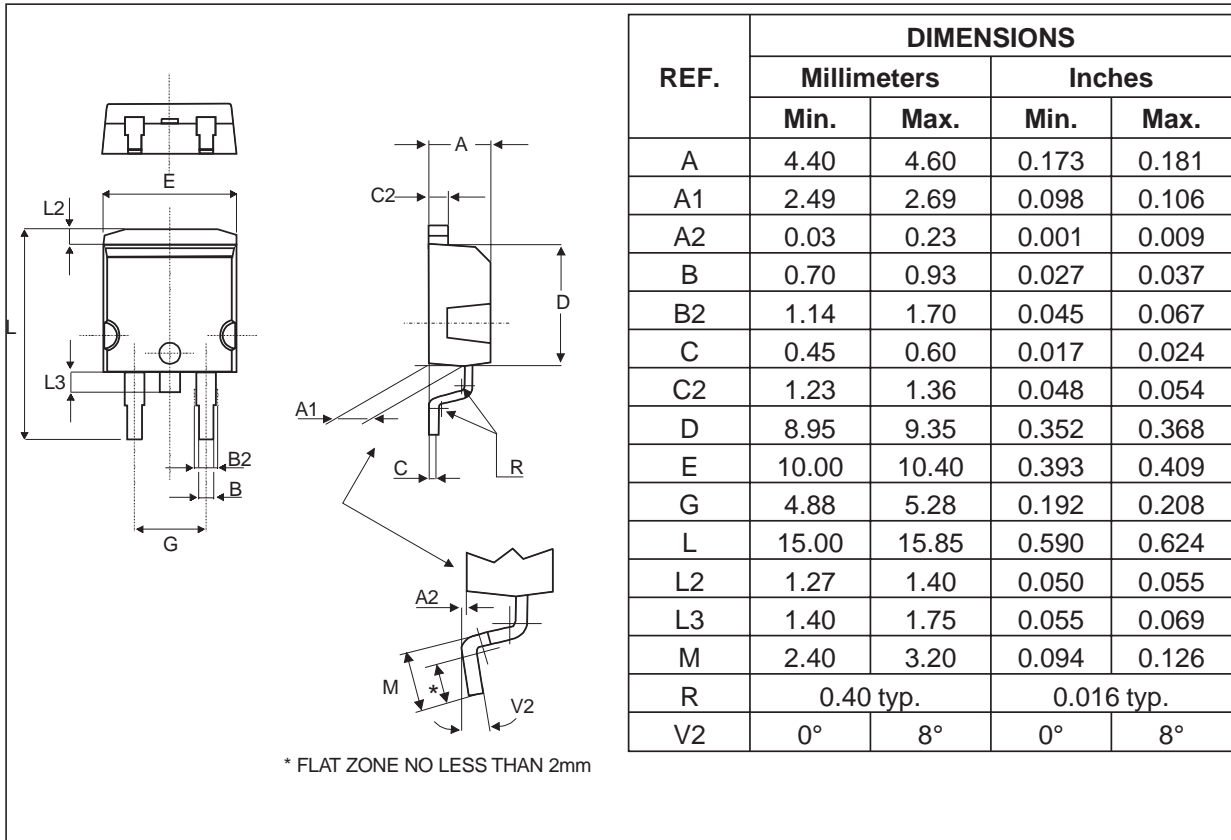


**Fig. 11:** Thermal resistance junction to ambient versus copper surface under tab (Epoxy printed circuit board FR4, copper thickness : 35  $\mu\text{m}$ ). (STPS20L15G only)

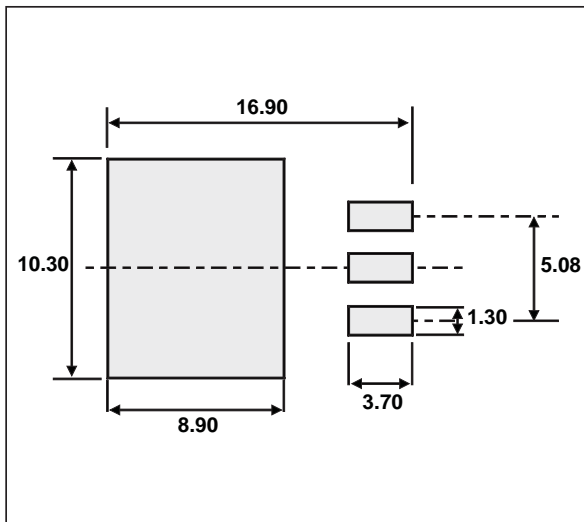


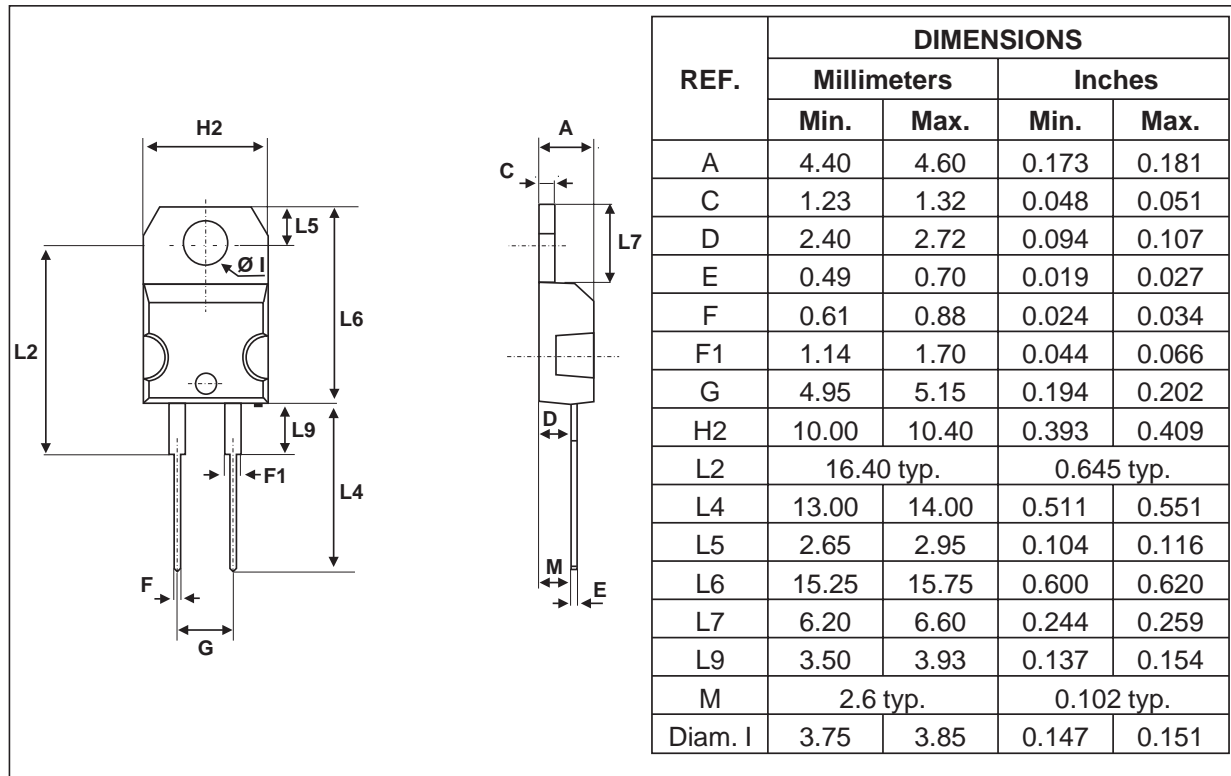
# STPS20L15D/G

## PACKAGE MECHANICAL DATA D<sup>2</sup>PAK



### FOOT PRINT DIMENSIONS (in millimeters)



**PACKAGE MECHANICAL DATA**  
 TO-220AC


Ordering type	Marking	Package	Weight	Base qty	Delivery mode
STPS20L15D	STPS20L15D	TO-220AC	1.86 g.	50	Tube
STPS20L15G	STPS20L15G	D <sup>2</sup> PAK	1.48g.	50	Tube
STPS20L15G-TR	STPS20L15G	D <sup>2</sup> PAK	1.48 g.	1000	Tape and reel

- Cooling method: by conduction (C)
- Recommended torque value: 0.55 m.N
- Maximum torque value: 0.7 m.N
- Epoxy meets UL94,V0

Information furnished is believed to be accurate and reliable. However, STMicroelectronics assumes no responsibility for the consequences of use of such information nor for any infringement of patents or other rights of third parties which may result from its use. No license is granted by implication or otherwise under any patent or patent rights of STMicroelectronics. Specifications mentioned in this publication are subject to change without notice. This publication supersedes and replaces all information previously supplied.

STMicroelectronics products are not authorized for use as critical components in life support devices or systems without express written approval of STMicroelectronics.

The ST logo is a registered trademark of STMicroelectronics

© 2003 STMicroelectronics - Printed in Italy - All rights reserved.

STMicroelectronics GROUP OF COMPANIES

Australia - Brazil - Canada - China - Finland - France - Germany  
 Hong Kong - India - Israel - Italy - Japan - Malaysia - Malta - Morocco - Singapore  
 Spain - Sweden - Switzerland - United Kingdom - United States.

<http://www.st.com>

