

4-line ESD protection for high speed lines

Datasheet – production data

Features

- Flow-through routing to keep signal integrity
- Ultralarge bandwidth: 6 GHz
- Ultralow capacitance: 0.6 pF
- Low time domain reflection
- Low leakage current: 100 nA at 25 °C
- Extended operating junction temperature range: -40 °C to 150 °C
- Package size in mm: 2 x 1 x 0.5
- RoHS compliant

Benefits

- High ESD robustness of the equipment
- Suitable for high density boards

Complies with following standards

- MIL-STD 883G Method 3015-7 Class 3B:
 - 8 kV
- IEC 61000-4-2 level 4:
 - 8 kV (contact discharge)

Applications

The HSP061-4NY8 is designed to protect against electrostatic discharge on sub micron technology circuits driving:

- HDMI 1.3 and 1.4
- Digital Video Interface
- Display Port
- USB 3.0
- Serial ATA

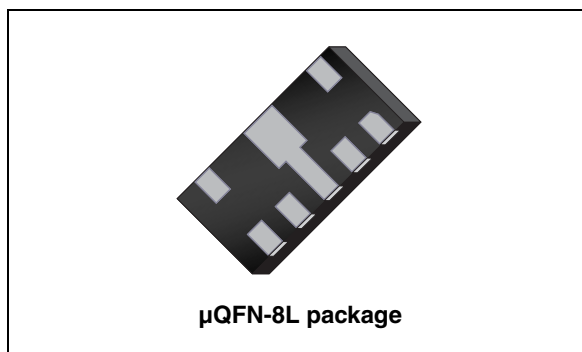
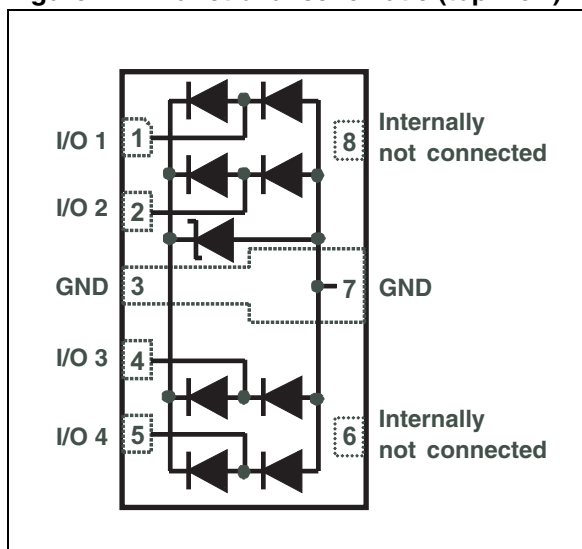

Figure 1. Functional schematic (top view)



Description

The HSP061-4NY8 is a 4-channel ESD array with a rail to rail architecture designed specifically for the protection of high speed differential lines.

The ultra-low variation of the capacitance ensures very low influence on signal-skew. The large bandwidth and the low reflection make it compatible with 5 Gbps.

The device is packaged in μQFN-8L with a 400 μm pitch, which minimizes the PCB area.

1 Characteristics

Table 1. Absolute maximum ratings $T_{amb} = 25\text{ °C}$

Symbol	Parameter		Value	Unit
V_{PP}	Peak pulse voltage	IEC 61000-4-2 contact discharge	8	kV
I_{pp}	Repetitive peak pulse current (8/20 μ s)		3	A
T_j	Operating junction temperature range		-40 to +150	$^{\circ}\text{C}$
T_{stg}	Storage temperature range		-65 to +150	$^{\circ}\text{C}$
T_L	Maximum lead temperature for soldering during 10 s		260	$^{\circ}\text{C}$

Table 2. Electrical characteristics $T_{amb} = 25\text{ °C}$

Symbol	Parameter	Test conditions	Min.	Typ.	Max.	Unit
V_{BR}	Breakdown voltage	$I_R = 1\text{ mA}$	6			V
I_{RM}	Leakage current	$V_{RM} = 3\text{ V}$			100	nA
V_{CL}	Clamping voltage	IEC 61000-4-2, +8 kV contact ($I_{PP} = 30\text{ A}$), measured at 30 ns		18		V
$C_{I/O - GND}$	Capacitance (input/output to ground)	$V_{I/O} = 0\text{ V}$, $F = (200\text{ MHz} - 3000\text{ MHz})$, $V_{OSC} = 30\text{ mV}$		0.5	0.6	pF
$\Delta C_{I/O - GND}$	Capacitance variation (input/output to ground)	$V_{I/O} = 0\text{ V}$ $F = 1\text{ MHz}$, $V_{OSC} = 30\text{ mV}$		0.03	0.05	pF
f_C	Cut-off frequency	-3dB		6		GHz
Z_{Diff}	Differential impedance	$t_r = 200\text{ ps}$ (10 - 90%) ⁽¹⁾ $Z_{0\text{ Diff}} = 100\ \Omega$	85	100	115	Ω

1. HDMI specification conditions. This information can be provided for other applications. Please contact your local ST office.

Figure 2. Leakage current versus junction temperature (typical values)

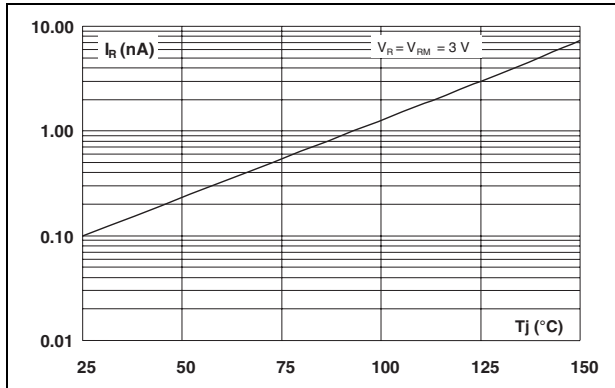

Figure 3. S21 attenuation measurement

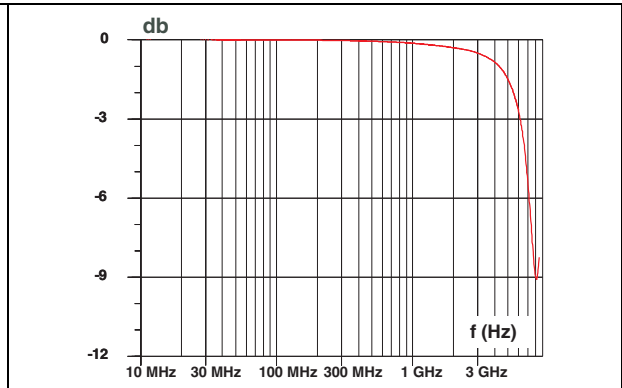

Figure 4. Differential impedance (Z_{diff})⁽¹⁾

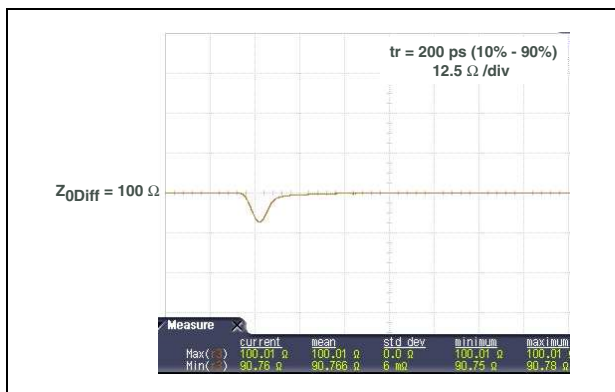
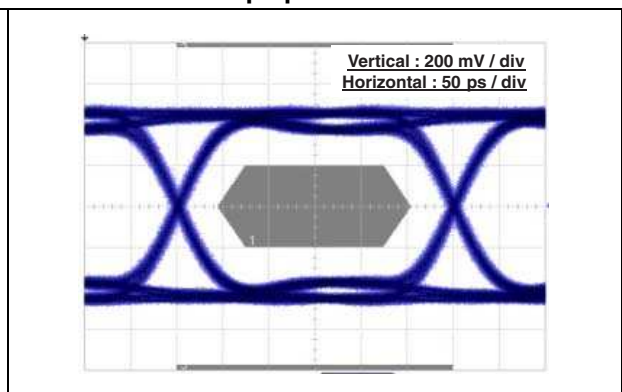

Figure 5. Eye diagram - HDMI mask at 3.4 Gbps per channel⁽¹⁾



1. HDMI specification conditions. This information can be provided for other applications. Please contact your local ST office.

Figure 6. ESD response to IEC 61000-4-2 (+8 kV contact discharge)

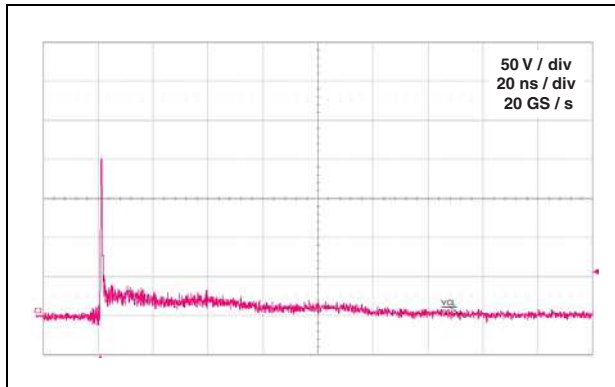
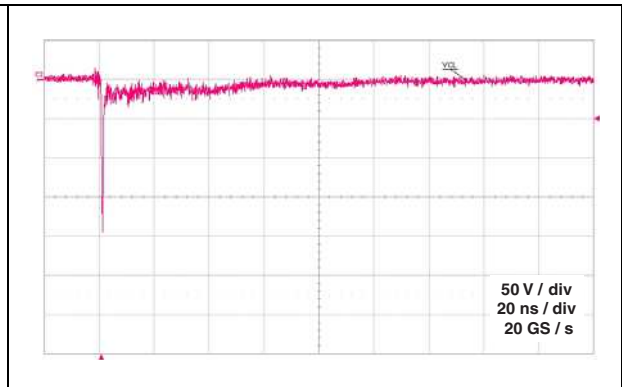
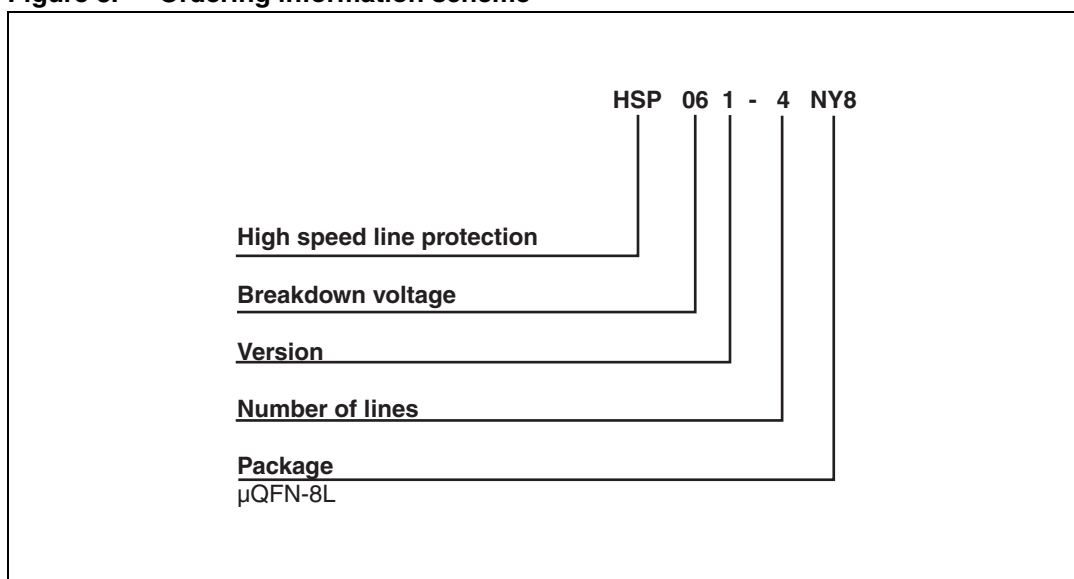

Figure 7. ESD response to IEC 61000-4-2 (-8 kV contact discharge)



2 Ordering information scheme

Figure 8. Ordering information scheme



3 Package information

- Epoxy meets UL94, V0
- Lead-free package

In order to meet environmental requirements, ST offers these devices in different grades of ECOPACK® packages, depending on their level of environmental compliance. ECOPACK® specifications, grade definitions and product status are available at: www.st.com. ECOPACK® is an ST trademark.

Table 3. μQFN-8L dimensions

Ref	Dimensions					
	Millimeters			Inches		
	Min	Typ	Max	Min	Typ	Max
A	0.45	0.50	0.55	0.018	0.020	0.022
A1	0.00	0.02	0.05	0.00	0.001	0.002
b	0.15	0.20	0.25	0.006	0.008	0.010
D	1.95	2.00	2.05	0.077	0.079	0.081
E	0.95	1.00	1.05	0.037	0.039	0.041
e	0.35	0.40	0.45	0.014	0.016	0.018
L	0.25	0.35	0.45	0.010	0.014	0.018
m		0.40			0.016	
n		0.15			0.006	
p		0.11			0.004	
r		0.05			0.002	

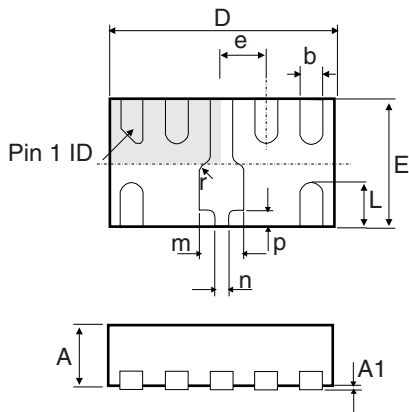

Figure 9. Footprint recommendations **Figure 10. Marking**
(dimensions in mm)

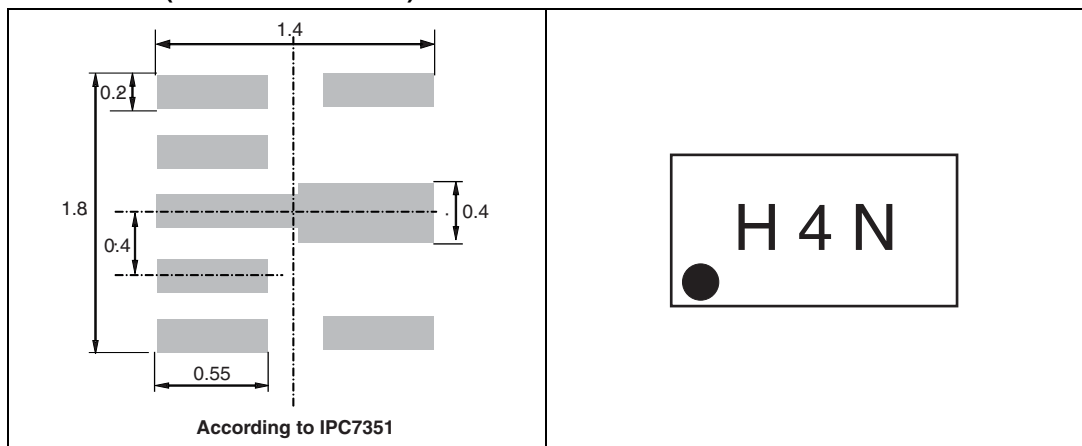
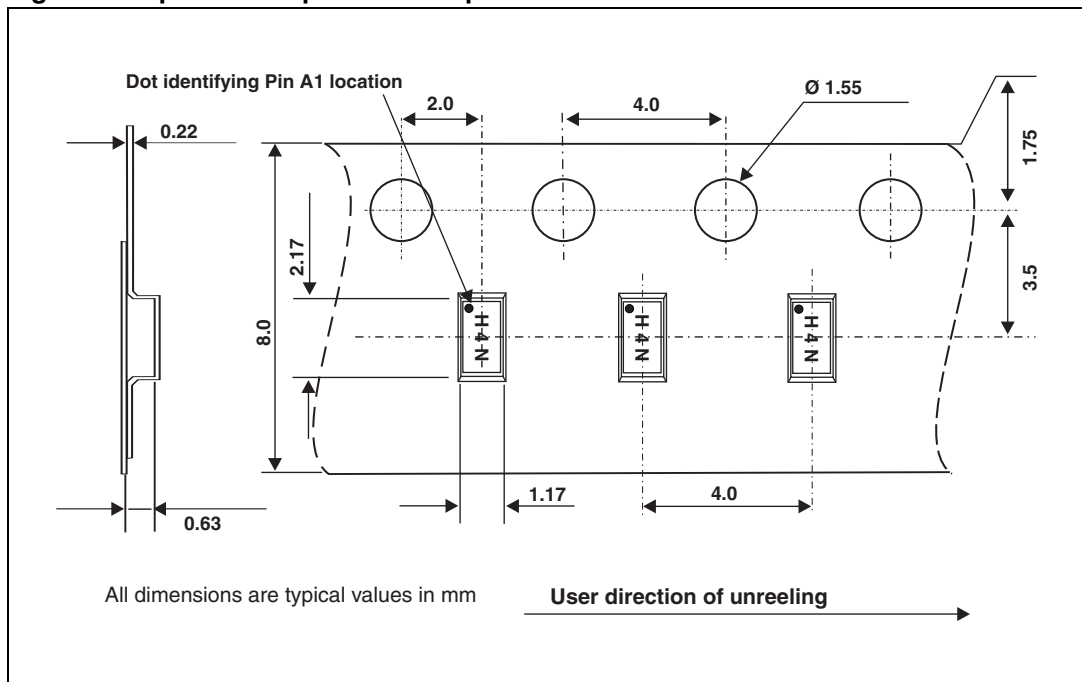
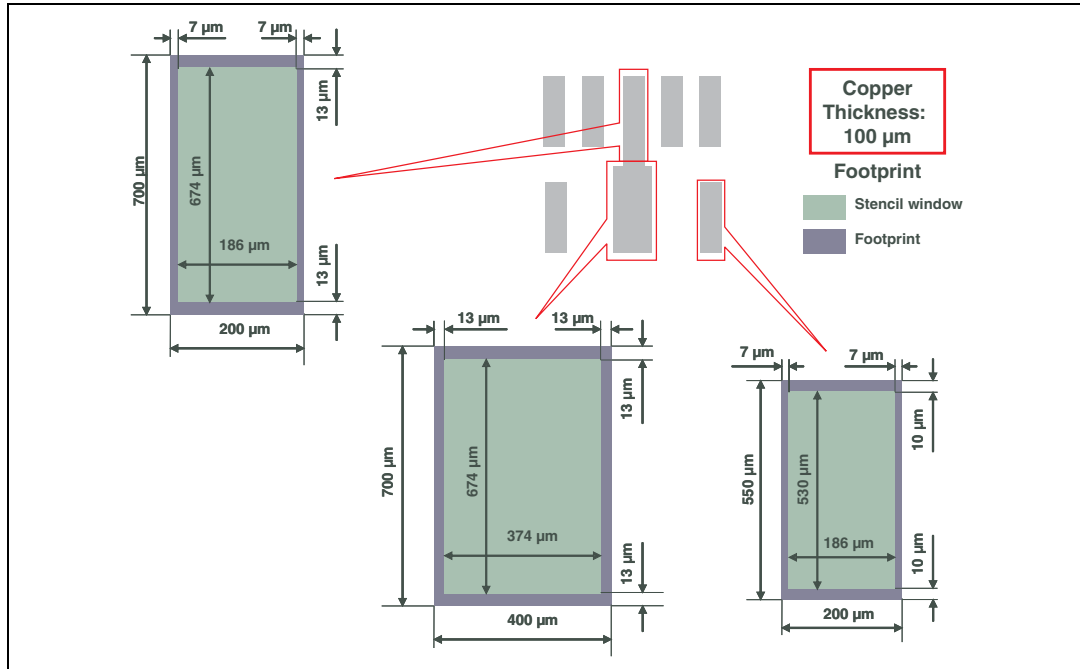

Figure 11. μ QFN-8L tape and reel specification



4 Recommendation on PCB assembly

Figure 12. Recommended stencil window position



4.1 Solder paste

1. Use halide-free flux, qualification ROL0 according to ANSI/J-STD-004.
2. “No clean” solder paste recommended.
3. Offers a high tack force to resist component displacement during PCB movement.
4. Use solder paste with fine particles: powder particle size 20-45 µm.

4.2 Placement

1. Manual positioning is not recommended.
2. It is recommended to use the lead recognition capabilities of the placement system, not the outline centering.
3. Standard tolerance of ± 0.05 mm is recommended.
4. 3.5 N placement force is recommended. Too much placement force can lead to squeezed out solder paste and cause solder joints to short. Too low placement force can lead to insufficient contact between package and solder paste that could cause open solder joints or badly centered packages.
5. To improve the package placement accuracy, a bottom side optical control should be performed with a high resolution tool.
6. For assembly, a perfect supporting of the PCB (all the more on flexible PCB) is recommended during solder paste printing, pick and place and reflow soldering by using optimized tools.

4.3 PCB design

1. To control the solder paste amount, the closed via is recommended instead of open vias.
2. The position of tracks and open vias in the solder area should be well balanced. The symmetrical layout is recommended, in case any tilt phenomena caused by asymmetrical solder paste amount due to the solder flow away.

Figure 13. Printed circuit board layout recommendations

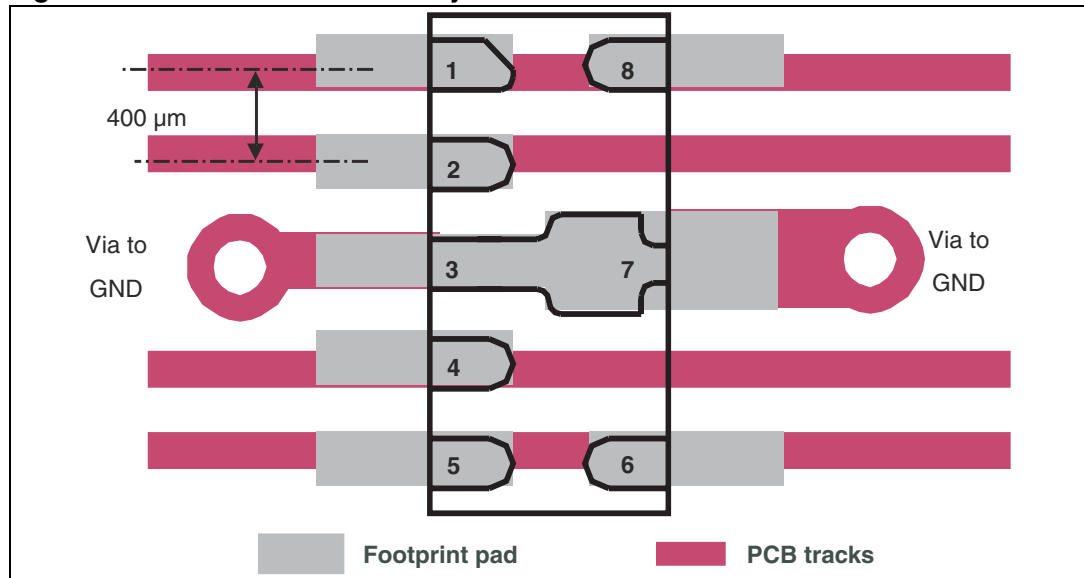

4.4 Reflow profile

Figure 14. ST ECOPACK® recommended soldering reflow profile for PCB mounting

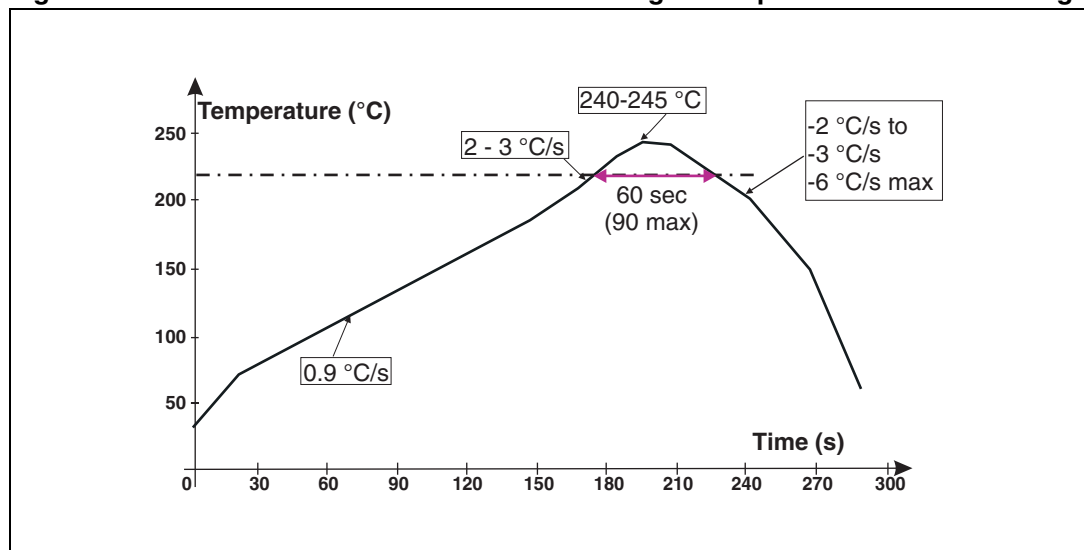

Note: Minimize air convection currents in the reflow oven to avoid component movement.

5 Ordering information

Table 4. Ordering information

Order code	Marking	Package	Weight	Base qty	Delivery mode
HSP061-4YN8	H4N	μQFN	2.77 mg	6000	Tape and reel (7")

6 Revision history

Table 5. Document revision history

Date	Revision	Changes
20-Apr-2010	1	Initial release.
15-Oct-2010	2	Updated values for $\Delta C_{I/O - GND}$ in Table 2 . Updated Figure 13 . Updated package name.
29-Mar-2012	3	Updated Table 2 . Updated weight value in Table 4 .

Please Read Carefully:

Information in this document is provided solely in connection with ST products. STMicroelectronics NV and its subsidiaries ("ST") reserve the right to make changes, corrections, modifications or improvements, to this document, and the products and services described herein at any time, without notice.

All ST products are sold pursuant to ST's terms and conditions of sale.

Purchasers are solely responsible for the choice, selection and use of the ST products and services described herein, and ST assumes no liability whatsoever relating to the choice, selection or use of the ST products and services described herein.

No license, express or implied, by estoppel or otherwise, to any intellectual property rights is granted under this document. If any part of this document refers to any third party products or services it shall not be deemed a license grant by ST for the use of such third party products or services, or any intellectual property contained therein or considered as a warranty covering the use in any manner whatsoever of such third party products or services or any intellectual property contained therein.

UNLESS OTHERWISE SET FORTH IN ST'S TERMS AND CONDITIONS OF SALE ST DISCLAIMS ANY EXPRESS OR IMPLIED WARRANTY WITH RESPECT TO THE USE AND/OR SALE OF ST PRODUCTS INCLUDING WITHOUT LIMITATION IMPLIED WARRANTIES OF MERCHANTABILITY, FITNESS FOR A PARTICULAR PURPOSE (AND THEIR EQUIVALENTS UNDER THE LAWS OF ANY JURISDICTION), OR INFRINGEMENT OF ANY PATENT, COPYRIGHT OR OTHER INTELLECTUAL PROPERTY RIGHT.

UNLESS EXPRESSLY APPROVED IN WRITING BY TWO AUTHORIZED ST REPRESENTATIVES, ST PRODUCTS ARE NOT RECOMMENDED, AUTHORIZED OR WARRANTED FOR USE IN MILITARY, AIR CRAFT, SPACE, LIFE SAVING, OR LIFE SUSTAINING APPLICATIONS, NOR IN PRODUCTS OR SYSTEMS WHERE FAILURE OR MALFUNCTION MAY RESULT IN PERSONAL INJURY, DEATH, OR SEVERE PROPERTY OR ENVIRONMENTAL DAMAGE. ST PRODUCTS WHICH ARE NOT SPECIFIED AS "AUTOMOTIVE GRADE" MAY ONLY BE USED IN AUTOMOTIVE APPLICATIONS AT USER'S OWN RISK.

Resale of ST products with provisions different from the statements and/or technical features set forth in this document shall immediately void any warranty granted by ST for the ST product or service described herein and shall not create or extend in any manner whatsoever, any liability of ST.

ST and the ST logo are trademarks or registered trademarks of ST in various countries.

Information in this document supersedes and replaces all information previously supplied.

The ST logo is a registered trademark of STMicroelectronics. All other names are the property of their respective owners.

© 2012 STMicroelectronics - All rights reserved

STMicroelectronics group of companies

Australia - Belgium - Brazil - Canada - China - Czech Republic - Finland - France - Germany - Hong Kong - India - Israel - Italy - Japan - Malaysia - Malta - Morocco - Philippines - Singapore - Spain - Sweden - Switzerland - United Kingdom - United States of America

www.st.com