



REED SWITCH DEVELOPMENTS CORP.

2524 Norwood Court
Racine, WI 53403
Ph: (262)883-9060

sales@reedswitchdevelopments.com

SPECIFICATION SHEET

Assembly Part Number:
2052-1965-000

Reed Specifications

Physical	Configuration*	SPST	
	Form*	A	
	Contact Position	CENTER	
	Glass L	19.00	mm
	Glass D	2.60	mm
	Total L*	55.00	mm
	Wire D	0.70	mm
	Gap Location	CENTER	
	Mount Spec*	THRU	
	Contact Material	RHODIUM	
	Max Vibration Resistance	35	G
	Max Shock Resistance (11 ms)	50	G
	Lead Tensile Strength	N/A	KG
	Operating	Pull in (+/- 2AT)*	20 - 25
Drop out*		15	AT
Operate Time		2.00	ms
Bounce Time		0.50	ms
Release Time		0.10	ms
Resonant Frequency		4200	Hz
Max Operating Frequency		300	Hz
Operating Temperature Range		-40 - 105	°C
Storage Temperature		N/A	°C
DC Contact Rating		40	W
Electrical	AC Contact Rating	40	VA
	DC Switching Voltage	400	VDC
	AC Switching Voltage	400	VAC
	DC Switching Current	2.00	A
	AC Switching Current	2.00	A
	DC Max Carry Current	3.00	A
	AC Max Carry Current	3.00	A
	Min Breakdown Voltage	1000	VDC
	Max Initial Contact Resistance	80	mOhm
	Typical Initial Contact Resistance	N/A	mOhm
	Max Contact Capacitance	0.50	pF
Min Insulation Resistance	10 ¹¹	Ohm	

* Pre-processed, bare reed element

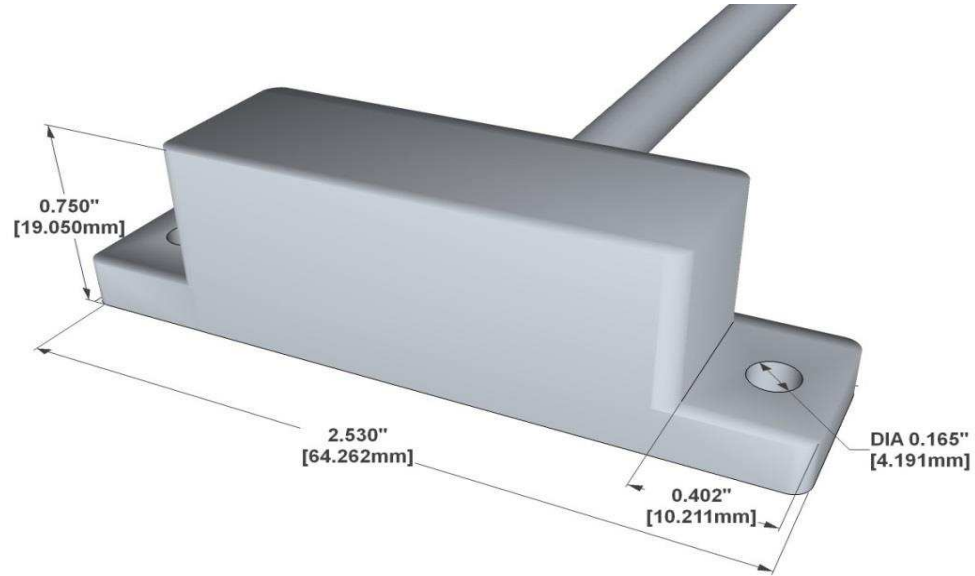

Assembly Characteristics

Housing	2052
Housing Material	CELANEX 3316
Reed	1965
Configuration	SPST
Form	A

Wire/Cable Characteristics

Type	CABLE	
Length	18/457.2	in/mm
Conductor Count	2	
Colors	RED,BLK	
Insulation Material & Description	PVC	
Gauge	20	AWG
Stranded Copper	19	STR
Maximum temperature	105	°C

Standard Actuator/Minimum Make Distance

2053-4109-000 - Alnico 5 - Cylinder	.81/20.57	in/mm
-------------------------------------	-----------	-------

Assembly Certifications

UL RECOGNIZED (File #: E102207)	Y	
RoHS	Y	

For More Information Visit:
www.reedswitchdevelopments.com

Or Call Us At:
262-883-9060

IT SHALL BE THE RESPONSIBILITY OF THE BUYER TO ENSURE THAT THE GOODS ARE SUFFICIENT AND SUITABLE FOR THE PURPOSE OR PURPOSES INTENDED (WHETHER BY THE BUYER OR BY ANY THIRD PARTY) AND THAT THEIR CAPACITY AND PERFORMANCE IS NOT ADVERSELY AFFECTED BY ANY ITEMS USED IN THEIR INSTALLATION (WHERE RELEVANT) AND/OR IN CONNECTION WITH THEM.