

Photomicrosensor (Transmissive) EE-SX1106

⚠ Be sure to read Precautions on page 25.

■ Dimensions

Note: All units are in millimeters unless otherwise indicated.

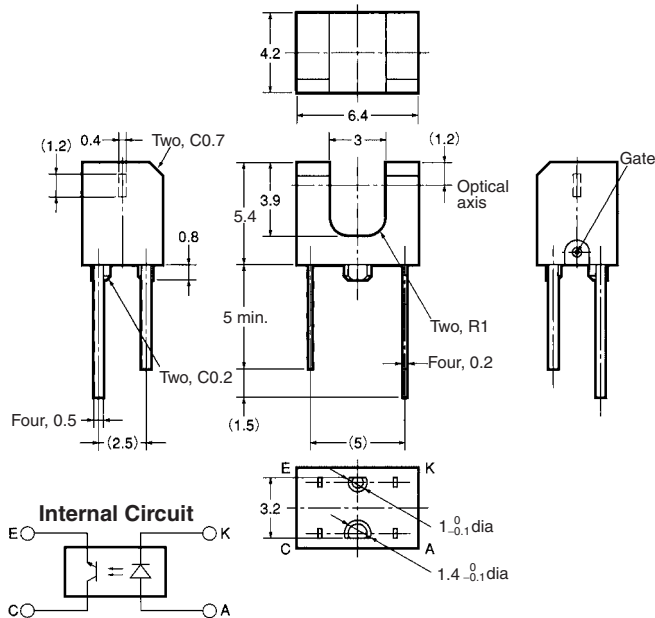

Terminal No.	Name
A	Anode
K	Cathode
C	Collector
E	Emitter

Unless otherwise specified, the tolerances are ± 0.2 mm.

■ Features

- Ultra-compact with a slot width of 3 mm.
- PCB mounting type.
- High resolution with a 0.4-mm-wide aperture.

■ Absolute Maximum Ratings (Ta = 25°C)

Item	Symbol	Rated value
Emitter	Forward current	I_F 50 mA (see note 1)
	Pulse forward current	I_{FP} ---
	Reverse voltage	V_R 5 V
Detector	Collector–Emitter voltage	V_{CEO} 30 V
	Emitter–Collector voltage	V_{ECO} 4.5 V
	Collector current	I_C 30 mA
	Collector dissipation	P_C 80 mW (see note 1)
Ambient temperature	Operating	T_{opr} -25°C to 85°C
	Storage	T_{stg} -30°C to 85°C
Soldering temperature	T_{sol}	260°C (see note 2)

Note: 1. Refer to the temperature rating chart if the ambient temperature exceeds 25°C.

2. Complete soldering within 3 seconds.

■ Electrical and Optical Characteristics (Ta = 25°C)

Item	Symbol	Value	Condition
Emitter	Forward voltage	V_F 1.3 V typ., 1.6 V max.	$I_F = 50$ mA
	Reverse current	I_R 10 μ A max.	$V_R = 5$ V
	Peak emission wavelength	λ_P 950 nm typ.	$I_F = 50$ mA
Detector	Light current	I_L 0.2 mA min.	$I_F = 20$ mA, $V_{CE} = 5$ V
	Dark current	I_D 500 nA max.	$V_{CE} = 10$ V, 0 lx
	Leakage current	I_{LEAK} ---	---
	Collector–Emitter saturated voltage	$V_{CE(sat)}$ 0.4 V max.	$I_F = 20$ mA, $I_L = 0.1$ mA
	Peak spectral sensitivity wavelength	λ_P 800 nm typ.	$V_{CE} = 5$ V
Rising time	t_r	10 μ s typ.	$V_{CC} = 5$ V, $R_L = 100$ Ω , $I_F = 20$ mA
Falling time	t_f	10 μ s typ.	$V_{CC} = 5$ V, $R_L = 100$ Ω , $I_F = 20$ mA

Engineering Data

Forward Current vs. Collector Dissipation Temperature Rating

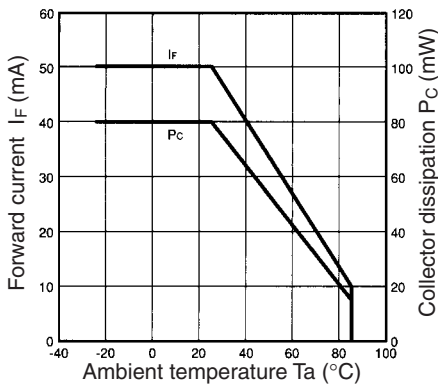

Forward Current vs. Forward Voltage Characteristics (Typical)

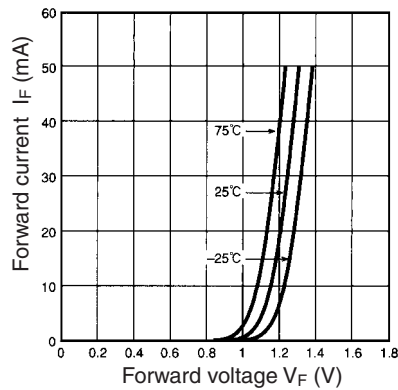

Light Current vs. Forward Current Characteristics (Typical)

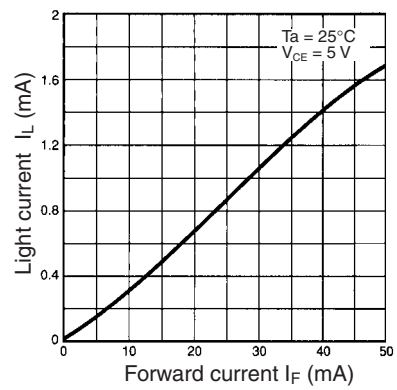

Light Current vs. Collector–Emitter Voltage Characteristics (Typical)

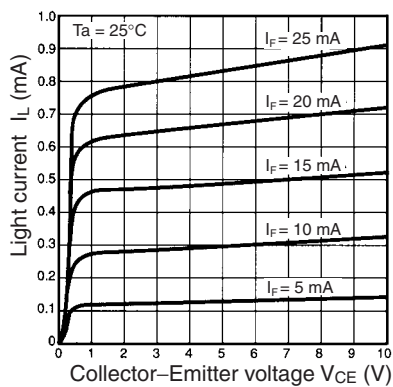

Relative Light Current vs. Ambient Temperature Characteristics (Typical)

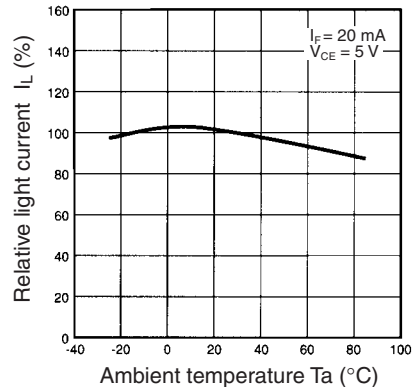

Dark Current vs. Ambient Temperature Characteristics (Typical)

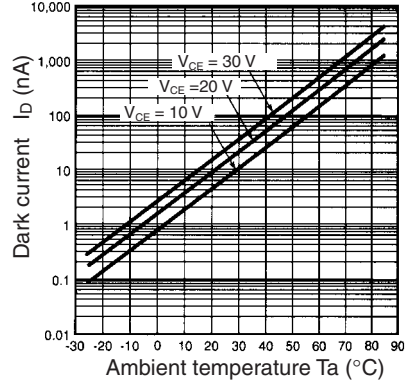

Response Time vs. Light Current Characteristics (Typical)

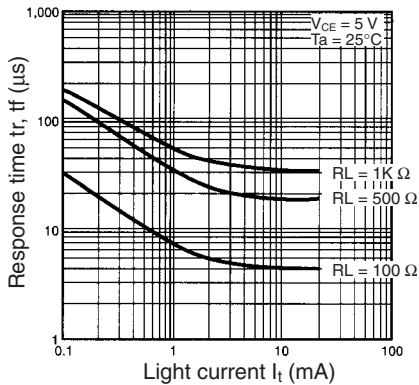

Sensing Position Characteristics (Typical)

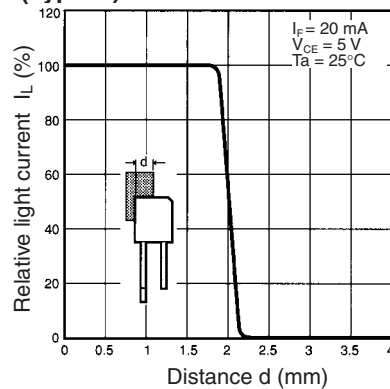

Sensing Position Characteristics (Typical)

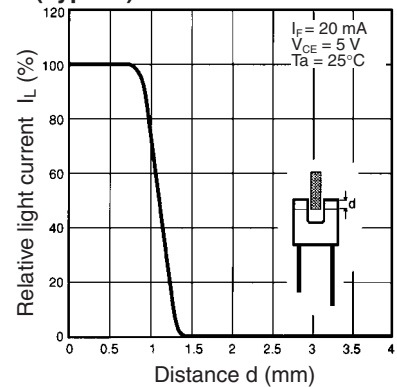

Response Time Measurement Circuit

