

Visit [nipponpulse.com](http://nipponpulse.com) to download 3D CAD drawings and 2D prints of this motor.

Electrical Specs	L250D		L250T		L250Q		
	L250D	L250D-1S	L250T	L250T-1S	L250Q	L250Q-1S	L250Q-2S
Continuous Force <sup>1</sup>	34N (7.6lbs)		52N (11.7lbs)		69N (15.5lbs)		
Continuous Current <sup>1</sup>	1.3Arms	2.6Arms	1.3Arms	3.9Arms	1.3Arms	5.2Arms	2.6Arms
Acceleration Force <sup>2</sup>	138N (31.0lbs)		207N (46.5lbs)		276N (62lbs)		
Acceleration Current <sup>2</sup>	5.2Arms	10.4Arms	5.2Arms	15.6Arms	5.2Arms	20.8Arms	10.4Arms
Force Constant (K <sub>f</sub> )	27N/amp	13N/amp	40N/amp	13N/amp	53N/amp	13N/amp	27N/amp
Back EMF (K <sub>e</sub> )	9V/m/s	4V/m/s	13V/m/s	4V/m/s	18V/m/s	4.4V/m/s	8.8V/m/s
Resistance 25°C <sup>3</sup>	8.4Ω	2.1Ω	13Ω	1.4Ω	17Ω	1Ω	4.2Ω
Inductance <sup>3</sup>	9.2mH	2.3mH	14mH	1.5mH	18mH	1.2mH	4.6mH
Electric Time Constant	1.11ms		1.11ms		1.11ms		
Fundamental Motor Constant (K <sub>m</sub> )	9.17N√W		11.23N√W		12.97N√W		
Magnetic Pitch (North-North)	90mm		90mm		90mm		

Is this the proper Linear Shaft Motor for your application? Use our [SMART sizing program](#) to assist in your decision.

This motor can be customized to fit your application demands; contact your application engineer for more information.

<sup>1</sup> Based on a temp rise of coil surface of 110°K over 25°C ambient temperature stalled forcer, and no external cooling or heat sinking.

<sup>2</sup> Can be maintained for a maximum of 40 seconds. Higher forces and current possible for short periods of time, contact Nippon Pulse for more information.

<sup>3</sup> All winding parameters listed are measured line-to-line (phase-to-phase).

Thermal Specs	L250D		L250T		L250Q		
	L250D	L250D-1S	L250T	L250T-1S	L250Q	L250Q-1S	L250Q-2S
Max Phase Temperature <sup>4</sup>	135°C (275°F)						
Thermal Resistance (Coil) (K <sub>v</sub> )	7.8°C/W (46°F/W)		5.2°C/W (41.4°F/W)		3.9°C/W (39°F/W)		

<sup>4</sup>The standard temperature difference between the coil and the forcer surface is 20°C.

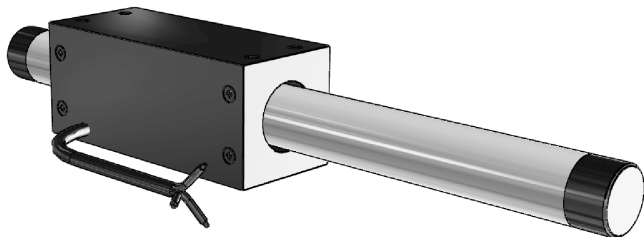

### Bus Voltage

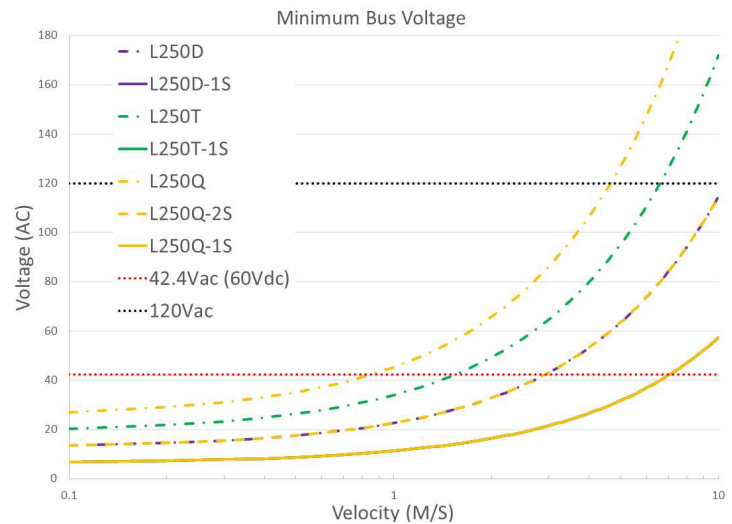

### Part Numbering System

L	—	Shaft Size 250	—	Forcer Size (A) <u>X</u>	—	Alt. Winding <u>XX</u>	—	Parallel Option <u>XX</u>	—	Usable Stroke (S) <u>XXXXst</u>	—	Options <u>XX</u>	—	Options <u>XX</u>
				D: Double (2) windings T: Triple (3) windings Q: Quadruple (4) windings		Blank: Standard _S: Alternate Winding		Blank: Single Motor PL: Parallel Motors		100-2000mm		Blank: Standard WP: Water Resistant HA: Digital Hall Effect CE: CE Type Motor FG: Frame Ground		Blank: Standard FO: Forcer Only SO: Shaft Only

Forcer Specs	L250D		L250T		L250Q		
	L250D	L250D-1S	L250T	L250T-1S	L250Q	L250Q-1S	L250Q-2S
Forcer Length (A)	120mm (4.72in)		165mm (6.5in)		210mm (8.27in)		
Forcer Width	50mm (1.97in)		50mm (1.97in)		50mm (1.97in)		
Forcer Screw Pitch (P)	105mm (4.1in)		150mm (5.9in)		195mm (7.7in)		
Forcer Weight	0.77kg (1.7lbs)		1.1kg (2.4lbs)		1.5kg (3.3lbs)		
Gap	2.0mm (0.08in)		2.0mm (0.08in)		2.0mm (0.08in)		

Tolerances are as follows:

Dimension (mm)	Tolerance (mm)
0 - 6	±0.1
7 - 30	±0.2
31 - 120	±0.3
121 - 315	±0.5
316 - 1000	±0.8
1001 - 2000	±1.2
2000 -	±1.5

L = See Shaft Length  
L1 = Usable Stroke + A  
L2 = See Support Length  
A = See Forcer Length  
P = See Forcer Screw Pitch

Unless otherwise specified, dimensions are in mm

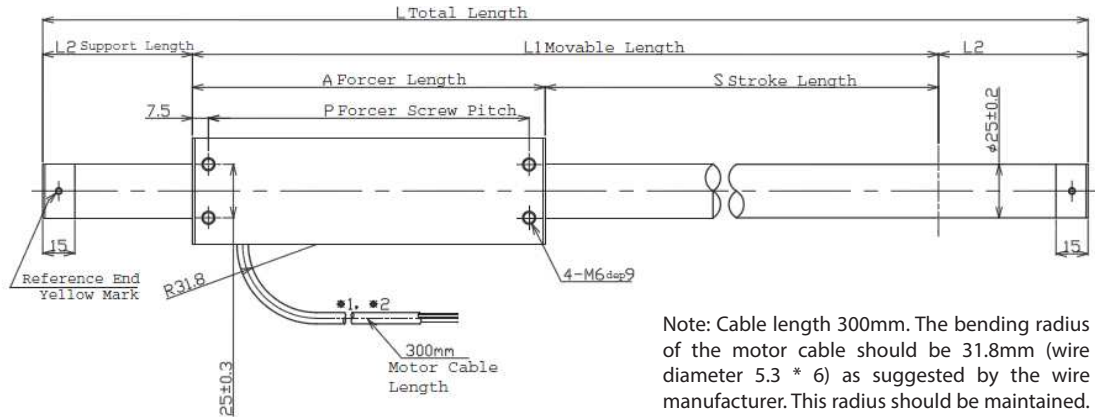

Note: Cable length 300mm. The bending radius of the motor cable should be 31.8mm (wire diameter 5.3 \* 6) as suggested by the wire manufacturer. This radius should be maintained. Use supplied connector to attach the proper high-flex cable as required by your application.

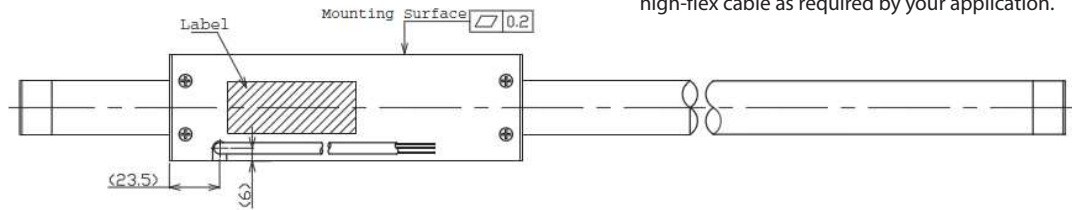
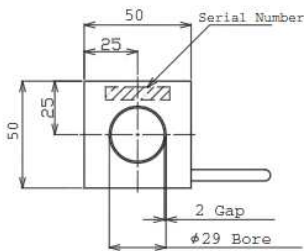

### Hall Effect Specs

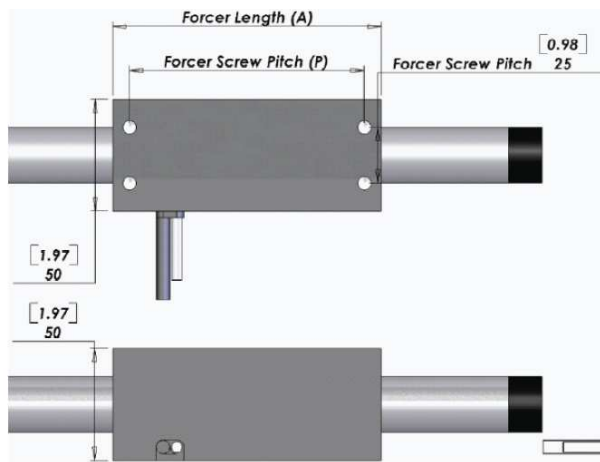

Note: The bending radius of the motor cable should be R31.8mm (wire diameter 4.6 \* 6) as suggested by the wire manufacturer. This radius should be maintained. Use supplied connector to attach the proper high flex cable as required by your application.

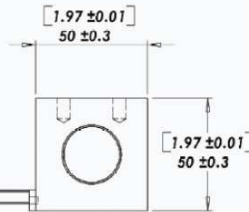

### Sensor Cable Specs

Wire Type	UL 758
Wire AWG	28
VCC	White/Red
GND	White/Black
Sensor 1	Orange/Red
Sensor 2	Orange/Black
Sensor 3	Gray/Red

The bending radius of the sensor cable should be R27.6mm (wire diameter 6.1 \* 6) as suggested by the wire manufacturer. This radius should be maintained. Attach the proper high flex cable as required by your application.

## FG Type Motor Cable

Wire Type	UL 1330
Wire AWG	20
Frame Ground	Green/Yellow

Wire Type	UL 2464FA	300mm lead wire bare leads. The bending radius of the motor cable should be 31.8mm as suggested by the wire manufacturer.
Wire AWG	20	
U Phase	Red	
V Phase	White	
W Phase	Black	

Ground Wire		300mm lead wire bare leads. The bending radius of the motor cable should be 18.96mm as suggested by the wire manufacturer. FG type with insulating sheet between coils and case. Meets all requirements of EN60034-1 (1998).
Wire Type	UL 1330	
Wire AWG	24	
U Phase	Red	
V Phase	White	
W Phase	Black	

## Forcer Spacing Distance

Spec	L250T	L250Q
Forcer Spacing Distance	15mm	
Pole (N/S) Distance	45mm	
Forcer Length	165mm	210mm
Flip Forcers	No	Yes

Tandem L250D forcers are possible, but are equivalent to one (1) L250Q forcer and thus are not listed above.

## Support and Bending

Stroke	Support Length (L2)	Max. Bending
0~700	50mm	0.00mm
701~1000	70mm	0.30mm
1001~1500	70mm	0.70mm
1501~max	100mm	0.70mm

Shaft Diameter (D) - 20.5mm ±0.2

Total Length (L)=Stroke (S)+Forcer Length(A)+(Support Length (L2)x2)

## Tandem Forcer



## Connector (Motor Cable)

Receptacle Housing	HLR-03V
Plug Housing	HLP-03V
Retainer	HLS-03V
Pin Contact	SSM-21T-P1.4
Socket Contact	SSF-21T-P1.4

To be installed by the user.

## THM Option

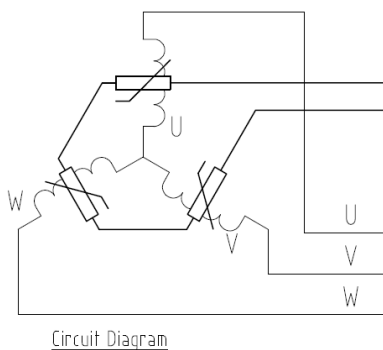

4. Thermistor  
PTCSL20T071DBE(Vishay)

## Thermocouple

Thermal sensor  
Thermocouple K type (marked each phase name)  
Attached to the surface of inside of coil  
Length 3000mm

Note: Metric units guaranteed. Imperial (United States customary) units are calculated.

## Shaft Length (L)

Stroke	L250D	L250T	L250Q
100	320mm (12.6in)	365mm (14.4in)	410mm (16.1in)
150	370mm (14.6in)	415mm (16.3in)	460mm (18.1in)
200	420mm (16.5in)	465mm (18.3in)	510mm (20.1in)
250	470mm (18.5in)	515mm (20.3in)	560mm (22in)
300	520mm (20.5in)	565mm (22.2in)	610mm (24in)
350	570mm (22.4in)	615mm (24.2in)	660mm (26in)
400	620mm (24.4in)	665mm (26.2in)	710mm (28in)
450	670mm (26.4in)	715mm (28.1in)	760mm (29.9in)
500	720mm (28.3in)	765mm (30.1in)	810mm (31.9in)
550	770mm (30.3in)	815mm (32.1in)	860mm (33.9in)
600	820mm (32.3in)	865mm (34.1in)	910mm (35.8in)
650	870mm (34.3in)	915mm (36in)	960mm (37.8in)
700	920mm (36.2in)	965mm (38in)	1010mm (39.8in)
750	1010mm (39.8in)	1055mm (41.5in)	1100mm (43.3in)
800	1060mm (41.7in)	1105mm (43.5in)	1150mm (45.3in)
850	1110mm (43.7in)	1155mm (45.5in)	1200mm (47.2in)
900	1160mm (45.7in)	1205mm (47.4in)	1250mm (49.2in)
950	1210mm (47.6in)	1255mm (49.4in)	1300mm (51.2in)
1000	1260mm (49.6in)	1305mm (51.4in)	1350mm (53.1in)
1050	1310mm (51.6in)	1355mm (53.3in)	1400mm (55.1in)
1100	1360mm (53.5in)	1405mm (55.3in)	1450mm (57.1in)
1150	1410mm (55.5in)	1455mm (57.3in)	1500mm (59.1in)
1200	1460mm (57.5in)	1505mm (59.3in)	1550mm (61in)
1250	1510mm (59.4in)	1555mm (61.2in)	1600mm (63in)
1300	1560mm (61.4in)	1605mm (63.2in)	1650mm (65in)
1350	1610mm (63.4in)	1655mm (65.2in)	1700mm (66.9in)
1400	1660mm (65.4in)	1705mm (67.1in)	1750mm (68.9in)
1450	1710mm (67.3in)	1755mm (69.1in)	1800mm (70.9in)
1500	1760mm (69.3in)	1805mm (71.1in)	1850mm (72.8in)
1550	1870mm (73.6in)	1915mm (75.4in)	1960mm (77.2in)
1600	1920mm (75.6in)	1965mm (77.4in)	2010mm (79.1in)
1650	1970mm (77.6in)	2015mm (79.3in)	2060mm (81.1in)
1700	2020mm (79.5in)	2065mm (81.3in)	2110mm (83.1in)
1750	2070mm (81.5in)	2115mm (83.3in)	2160mm (85in)
1800	2120mm (83.5in)	2165mm (85.2in)	2210mm (87in)
1850	2170mm (85.4in)	2215mm (87.2in)	2260mm (89in)
1900	2220mm (87.4in)	2265mm (89.2in)	2310mm (90.9in)
1950	2270mm (89.4in)	2315mm (91.1in)	2360mm (92.9in)
2000	2320mm (91.3in)	2365mm (93.1in)	2410mm (94.9in)

## Shaft Mass

Stroke	L250D	L250T	L250Q
100	0.9kg (2lb)	1.1kg (2.4lb)	1.2kg (2.6lb)
150	1.1kg (2.4lb)	1.2kg (2.6lb)	1.4kg (3.1lb)
200	1.2kg (2.6lb)	1.4kg (3.1lb)	1.6kg (3.5lb)
250	1.4kg (3.1lb)	1.6kg (3.5lb)	1.7kg (3.7lb)
300	1.6kg (3.5lb)	1.7kg (3.7lb)	1.9kg (4.2lb)
350	1.8kg (4lb)	1.9kg (4.2lb)	2.1kg (4.6lb)
400	1.9kg (4.2lb)	2.1kg (4.6lb)	2.2kg (4.9lb)
450	2.1kg (4.6lb)	2.3kg (5.1lb)	2.4kg (5.3lb)
500	2.3kg (5.1lb)	2.4kg (5.3lb)	2.6kg (5.7lb)
550	2.4kg (5.3lb)	2.6kg (5.7lb)	2.8kg (6.2lb)
600	2.6kg (5.7lb)	2.8kg (6.2lb)	2.9kg (6.4lb)
650	2.8kg (6.2lb)	2.9kg (6.4lb)	3.1kg (6.8lb)
700	3kg (6.6lb)	3.1kg (6.8lb)	3.3kg (7.3lb)
750	3.2kg (7.1lb)	3.4kg (7.5lb)	3.5kg (7.7lb)
800	3.4kg (7.5lb)	3.5kg (7.7lb)	3.7kg (8.2lb)
850	3.5kg (7.7lb)	3.7kg (8.2lb)	3.8kg (8.4lb)
900	3.7kg (8.2lb)	3.9kg (8.6lb)	4kg (8.8lb)
950	3.9kg (8.6lb)	4kg (8.8lb)	4.2kg (9.3lb)
1000	4.1kg (9lb)	4.2kg (9.3lb)	4.4kg (9.7lb)
1050	4.2kg (9.3lb)	4.4kg (9.7lb)	4.5kg (9.9lb)
1100	4.4kg (9.7lb)	4.6kg (10.1lb)	4.7kg (10.4lb)
1150	4.6kg (10.1lb)	4.7kg (10.4lb)	4.9kg (10.8lb)
1200	4.7kg (10.4lb)	4.9kg (10.8lb)	5.1kg (11.2lb)
1250	4.9kg (10.8lb)	5.1kg (11.2lb)	5.2kg (11.5lb)
1300	5.1kg (11.2lb)	5.2kg (11.5lb)	5.4kg (11.9lb)
1350	5.3kg (11.7lb)	5.4kg (11.9lb)	5.6kg (12.3lb)
1400	5.4kg (11.9lb)	5.6kg (12.3lb)	5.7kg (12.6lb)
1450	5.6kg (12.3lb)	5.8kg (12.8lb)	5.9kg (13lb)
1500	5.8kg (12.8lb)	5.9kg (13lb)	6.1kg (13.4lb)
1550	6kg (13.2lb)	6.2kg (13.7lb)	6.3kg (13.9lb)
1600	6.2kg (13.7lb)	6.3kg (13.9lb)	6.5kg (14.3lb)
1650	6.3kg (13.9lb)	6.5kg (14.3lb)	6.6kg (14.6lb)
1700	6.5kg (14.3lb)	6.7kg (14.8lb)	6.8kg (15lb)
1750	6.7kg (14.8lb)	6.8kg (15lb)	7kg (15.4lb)
1800	6.9kg (15.2lb)	7kg (15.4lb)	7.2kg (15.9lb)
1850	7kg (15.4lb)	7.2kg (15.9lb)	7.3kg (16.1lb)
1900	7.2kg (15.9lb)	7.4kg (16.3lb)	7.5kg (16.5lb)
1950	7.4kg (16.3lb)	7.5kg (16.5lb)	7.7kg (17lb)
2000	7.6kg (16.8lb)	7.7kg (17lb)	7.9kg (17.4lb)

Additional stroke lengths up to 2500 are available. Contact Nippon Pulse for more information.

For assistance in selecting the best motor for your application, contact Nippon Pulse to speak with an applications engineer. 1-540-633-1677

[www.nipponpulse.com](http://www.nipponpulse.com)