

IRG4BC15MD

INSULATED GATE BIPOLAR TRANSISTOR WITH
ULTRAFAST SOFT RECOVERY DIODE

Short Circuit Rated
Fast IGBT

Features

- Rugged: 10µsec short circuit capable at VGS = 15V
- Low VCE(on) for 4 to 10kHz applications
- IGBT co-packaged with ultra-soft-recovery anti-parallel diodes
- Industry standard TO-220AB package

Benefits

- Best Value for Appliance and Industrial applications
- Offers highest efficiency and short circuit capability for intermediate applications
- Provides best efficiency for the mid range frequency (4 to 10kHz)
- Optimized for Appliance and Industrial applications up to 1HP
- High noise immune "Positive Only" gate drive - Negative bias gate drive not necessary
- For Low EMI designs - requires little or no snubbing
- Single Package switch for bridge circuit applications
- Compatible with high voltage Gate Drive IC's
- Allows simpler gate drive

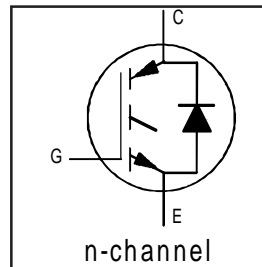

$V_{CES} = 600V$
$V_{CE(on)} \text{ typ.} = 1.88V$
@ $V_{GE} = 15V, I_C = 8.6A$

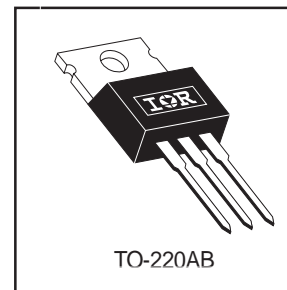

Absolute Maximum Ratings

	Parameter	Max.	Units
V_{CES}	Collector-to-Emitter Voltage	600	V
$I_C @ T_C = 25^\circ C$	Continuous Collector Current	14	A
$I_C @ T_C = 100^\circ C$	Continuous Collector Current	8.6	
I_{CM}	Pulsed Collector Current ①	28	
I_{LM}	Clamped Inductive Load Current ②	28	
$I_F @ T_C = 100^\circ C$	Diode Continuous Forward Current	4.0	
t_{sc}	Short Circuit Withstand Time	12	µs
I_{FM}	Diode Maximum Forward Current	16	A
V_{GE}	Gate-to-Emitter Voltage	± 20	V
$P_D @ T_C = 25^\circ C$	Maximum Power Dissipation	49	W
$P_D @ T_C = 100^\circ C$	Maximum Power Dissipation	19	
T_J T_{STG}	Operating Junction and Storage Temperature Range	-55 to +150	°C
	Soldering Temperature, for 10 sec.	300 (0.063 in. (1.6mm) from case)	
	Mounting Torque, 6-32 or M3 Screw.	10 lbf•in (1.1 N•m)	

Thermal Resistance

	Parameter	Min.	Typ.	Max.	Units
$R_{\theta JC}$	Junction-to-Case - IGBT	—	—	2.7	°C/W
$R_{\theta JC}$	Junction-to-Case - Diode	—	—	7.0	
$R_{\theta CS}$	Case-to-Sink, flat, greased surface	—	0.50	—	
$R_{\theta JA}$	Junction-to-Ambient, typical socket mount	—	—	80	
Wt	Weight	—	2 (0.07)	—	g (oz)

IRG4BC15MD

International
IR Rectifier

Electrical Characteristics @ $T_J = 25^\circ\text{C}$ (unless otherwise specified)

	Parameter	Min.	Typ.	Max.	Units	Conditions	
$V_{(BR)CES}$	Collector-to-Emitter Breakdown Voltage ^③	600	—	—	V	$V_{GE} = 0V, I_C = 250\mu A$	
$\Delta V_{(BR)CES}/\Delta T_J$	Temperature Coeff. of Breakdown Voltage	—	0.65	—	V/°C	$V_{GE} = 0V, I_C = 1.0mA$	
$V_{CE(on)}$	Collector-to-Emitter Saturation Voltage	—	1.88	2.3	V	$V_{GE} = 15V$ $I_C = 8.6A$	
		—	2.6	—			$I_C = 14A$
		—	2.1	—			$I_C = 8.6A, T_J = 150^\circ\text{C}$
$V_{GE(th)}$	Gate Threshold Voltage	4.0	—	6.5		$V_{CE} = V_{GE}, I_C = 250\mu A$	
$\Delta V_{GE(th)}/\Delta T_J$	Temperature Coeff. of Threshold Voltage	—	-10	—	mV/°C	$V_{CE} = V_{GE}, I_C = 250\mu A$	
g_{fe}	Forward Transconductance ^④	2.3	3.4	—	S	$V_{CE} = 100V, I_C = 6.5A$	
I_{CES}	Zero Gate Voltage Collector Current	—	—	250	μA	$V_{GE} = 0V, V_{CE} = 600V$	
		—	—	1400		$V_{GE} = 0V, V_{CE} = 600V, T_J = 150^\circ\text{C}$	
V_{FM}	Diode Forward Voltage Drop	—	1.5	1.8	V	$I_C = 4.0A$	
		—	1.4	1.7		$I_C = 4.0A, T_J = 150^\circ\text{C}$	
I_{GES}	Gate-to-Emitter Leakage Current	—	—	± 100	nA	$V_{GE} = \pm 20V$	

Switching Characteristics @ $T_J = 25^\circ\text{C}$ (unless otherwise specified)

	Parameter	Min.	Typ.	Max.	Units	Conditions	
Q_g	Total Gate Charge (turn-on)	—	46	—	nC	$I_C = 8.6A$ $V_{CC} = 400V$ $V_{GE} = 15V$	
Q_{ge}	Gate - Emitter Charge (turn-on)	—	4.2	—			
Q_{gc}	Gate - Collector Charge (turn-on)	—	15	—			
$t_{d(on)}$	Turn-On Delay Time	—	21	—	ns	$T_J = 25^\circ\text{C}$ $I_C = 8.6A, V_{CC} = 480V$ $V_{GE} = 15V, R_G = 75\Omega$ Energy losses include "tail" and diode reverse recovery.	
t_r	Rise Time	—	38	—			
$t_{d(off)}$	Turn-Off Delay Time	—	540	810			
t_f	Fall Time	—	350	530			
E_{on}	Turn-On Switching Loss	—	0.32	—	mJ		
E_{off}	Turn-Off Switching Loss	—	1.93	—			
E_{ts}	Total Switching Loss	—	2.25	3.6			
$t_{d(on)}$	Turn-On Delay Time	—	20	—	ns	$T_J = 150^\circ\text{C}$, $I_C = 8.6A, V_{CC} = 480V$ $V_{GE} = 15V, R_G = 75\Omega$ Energy losses include "tail" and diode reverse recovery.	
t_r	Rise Time	—	42	—			
$t_{d(off)}$	Turn-Off Delay Time	—	650	—			
t_f	Fall Time	—	590	—			
E_{ts}	Total Switching Loss	—	3.0	—	mJ		
L_E	Internal Emitter Inductance	—	7.5	—	nH	Measured 5mm from package	
C_{ies}	Input Capacitance	—	340	—	pF	$V_{GE} = 0V$ $V_{CC} = 30V$ $f = 1.0MHz$	
C_{oes}	Output Capacitance	—	35	—			
C_{res}	Reverse Transfer Capacitance	—	8.8	—			
t_{rr}	Diode Reverse Recovery Time	—	28	42	ns	$T_J = 25^\circ\text{C}$	$I_F = 4.0A$ $V_R = 200V$ $di/dt 200A/\mu s$
		—	38	57		$T_J = 125^\circ\text{C}$	
I_{rr}	Diode Peak Reverse Recovery Current	—	2.9	5.2	A	$T_J = 25^\circ\text{C}$	
		—	3.7	6.7		$T_J = 125^\circ\text{C}$	
Q_{rr}	Diode Reverse Recovery Charge	—	40	60	nC	$T_J = 25^\circ\text{C}$	
		—	70	110		$T_J = 125^\circ\text{C}$	
$di_{(rec)M}/dt$	Diode Peak Rate of Fall of Recovery During t_b	—	280	—	A/ μs	$T_J = 25^\circ\text{C}$	
		—	240	—		$T_J = 125^\circ\text{C}$	

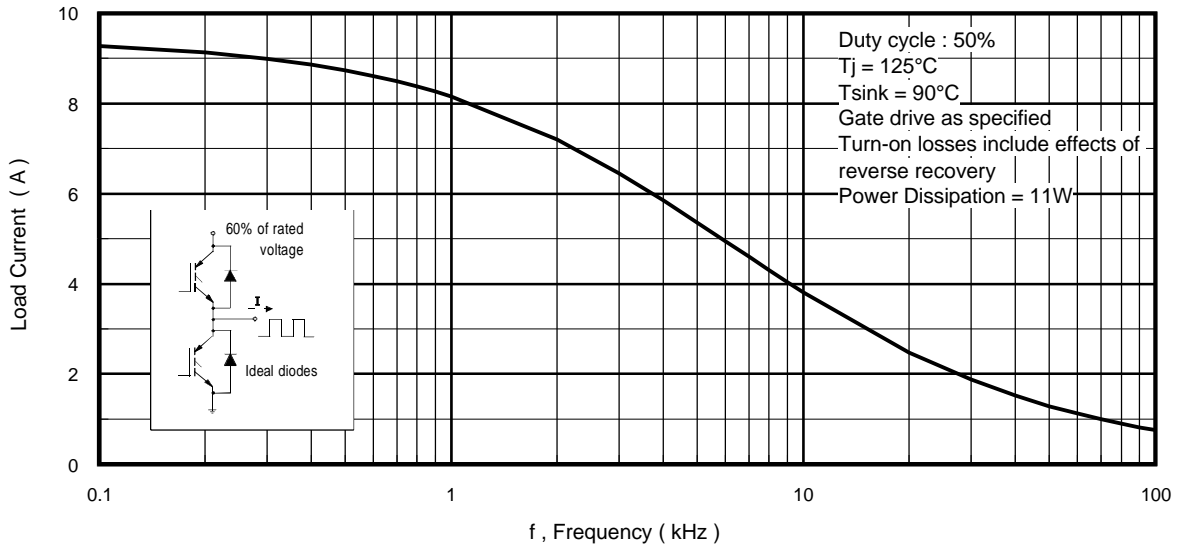

Fig. 1 - Typical Load Current vs. Frequency
 (Load Current = I_{RMS} of fundamental)

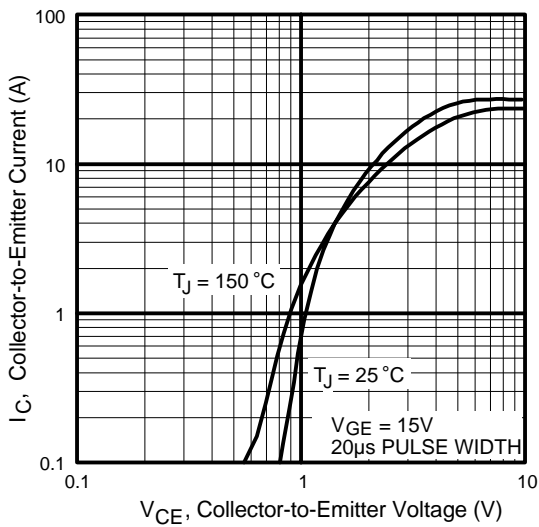

Fig. 2 - Typical Output Characteristics

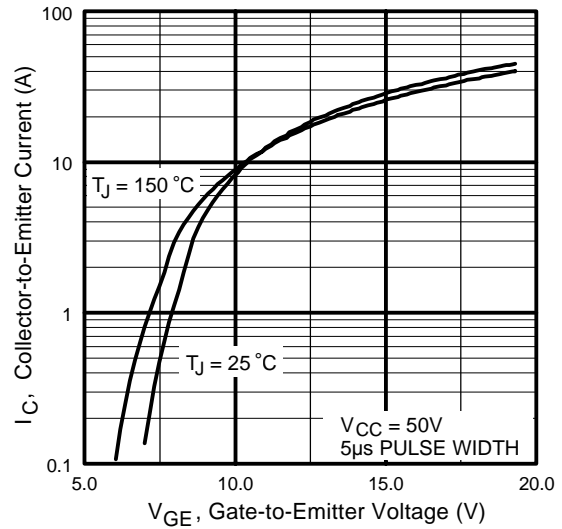

Fig. 3 - Typical Transfer Characteristics

IRG4BC15MD

International
IR Rectifier

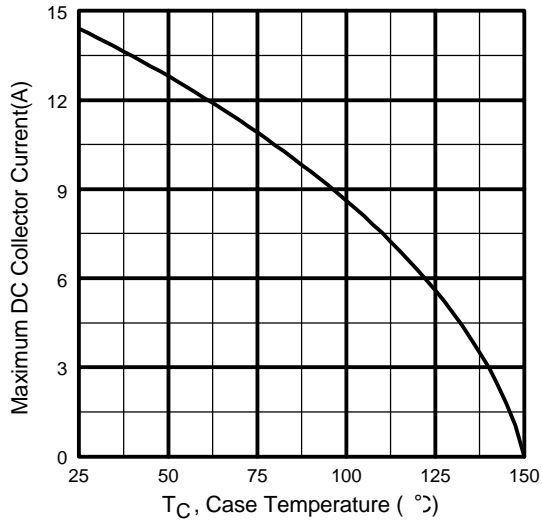

Fig. 4 - Maximum Collector Current vs. Case Temperature

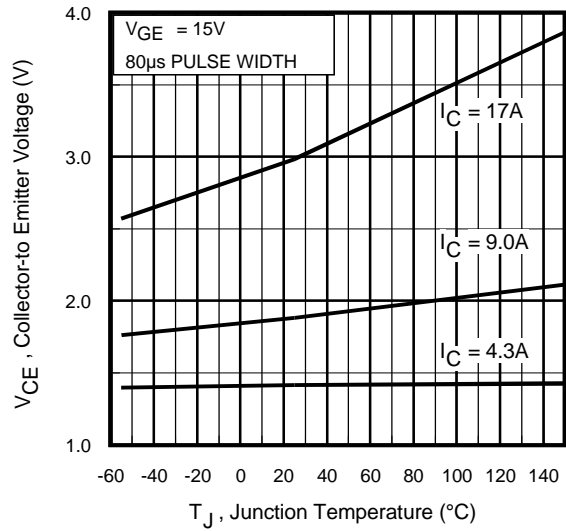

Fig. 5 - Typical Collector-to-Emitter Voltage vs. Junction Temperature

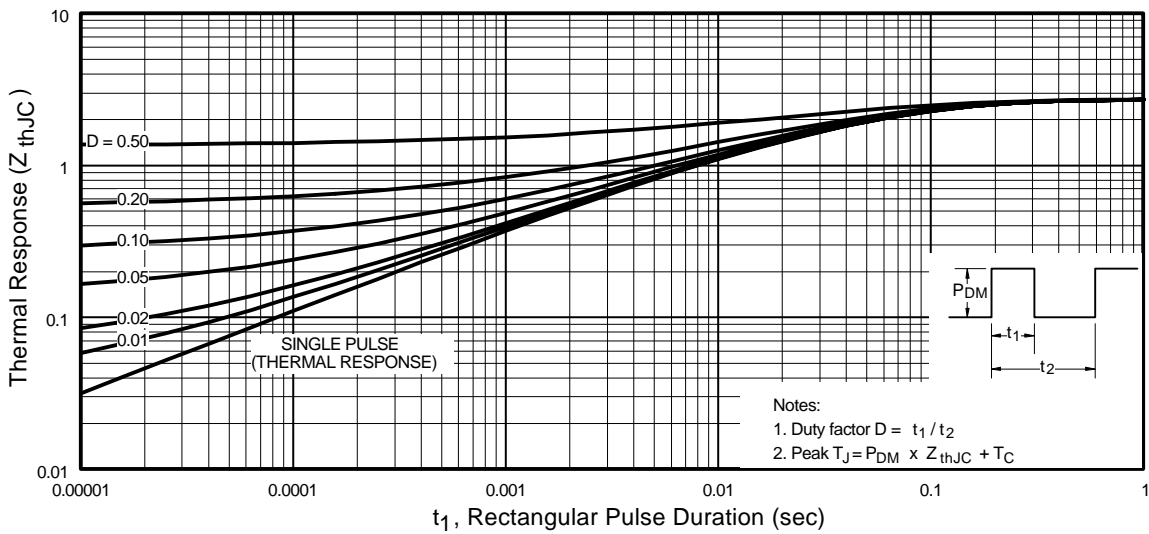

Fig. 6 - Maximum Effective Transient Thermal Impedance, Junction-to-Case

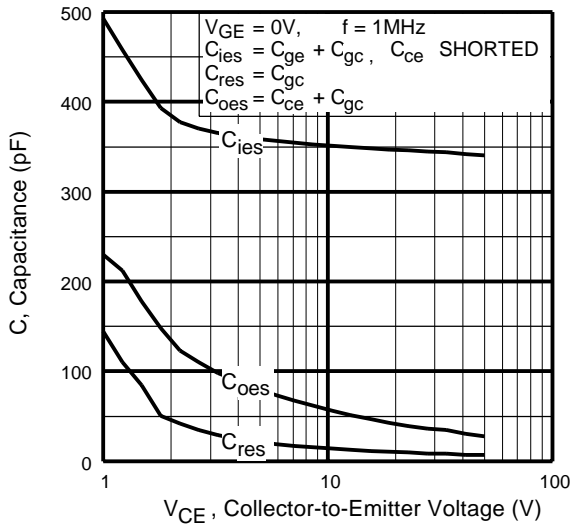

Fig. 7 - Typical Capacitance vs. Collector-to-Emitter Voltage

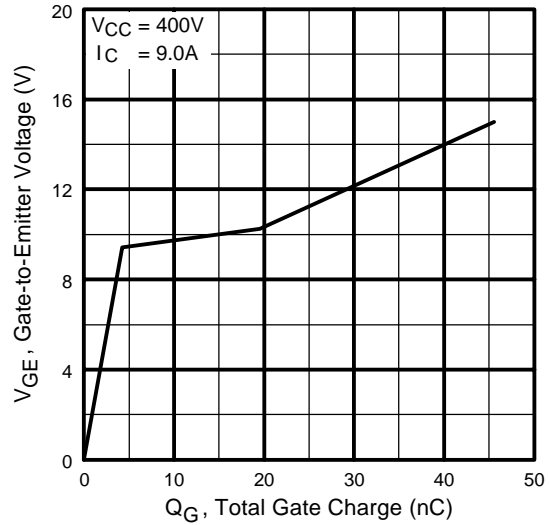

Fig. 8 - Typical Gate Charge vs. Gate-to-Emitter Voltage

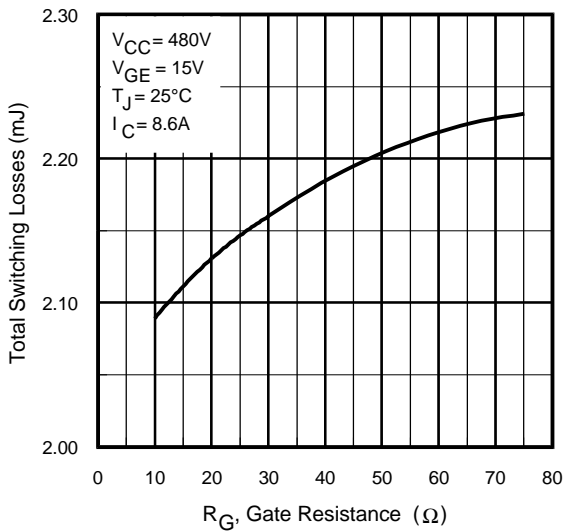

Fig. 9 - Typical Switching Losses vs. Gate Resistance

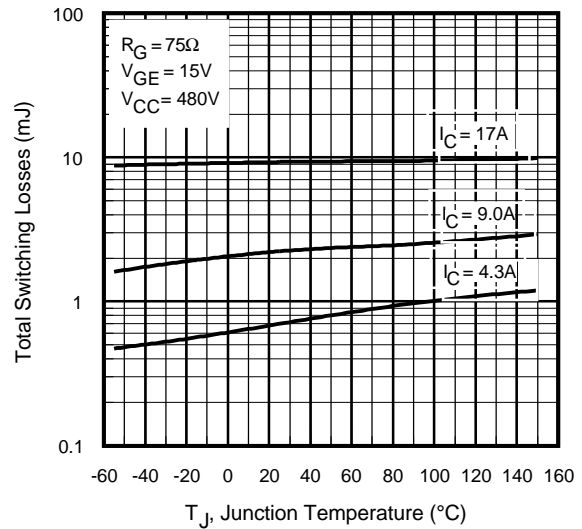

Fig. 10 - Typical Switching Losses vs. Junction Temperature

IRG4BC15MD

International
IR Rectifier

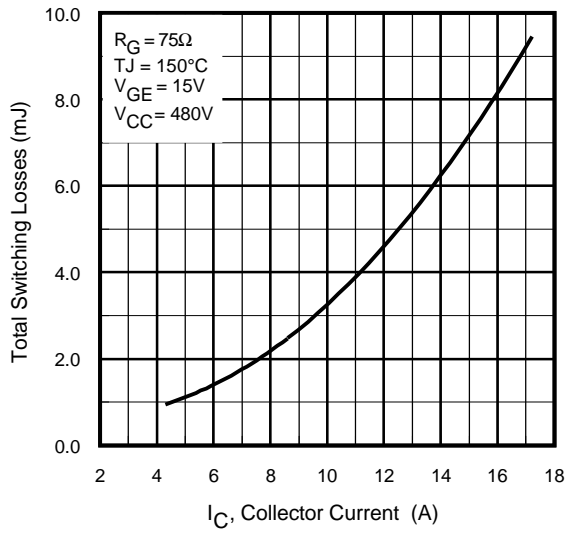

Fig. 11 - Typical Switching Losses vs. Collector-to-Emitter Current

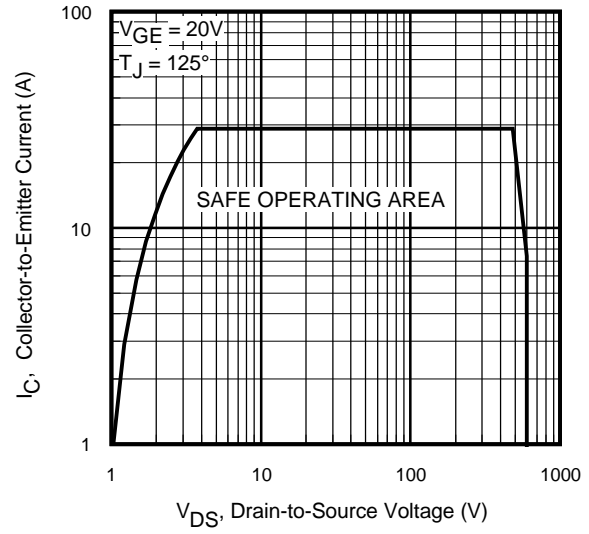
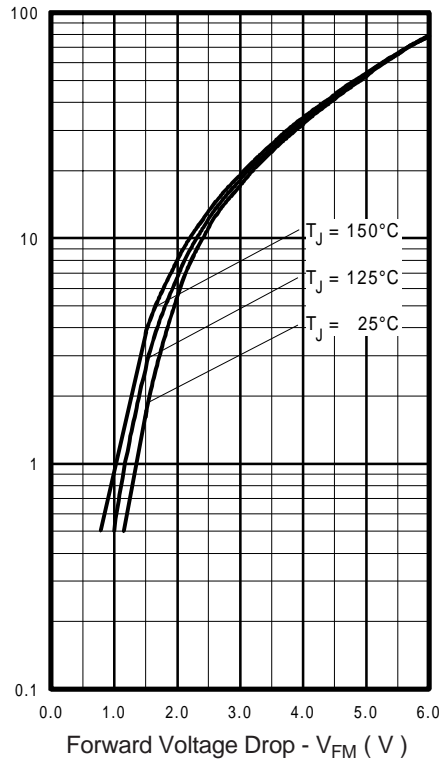

Fig. 12 - Turn-Off SOA



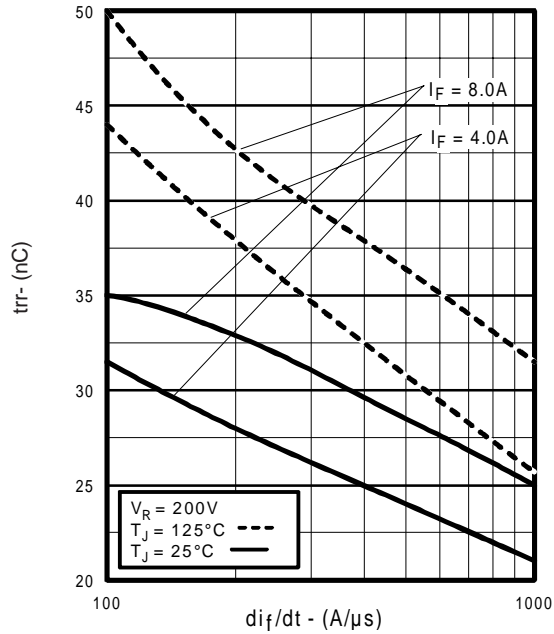

Fig. 14 - Typical Reverse Recovery vs. di_f/dt

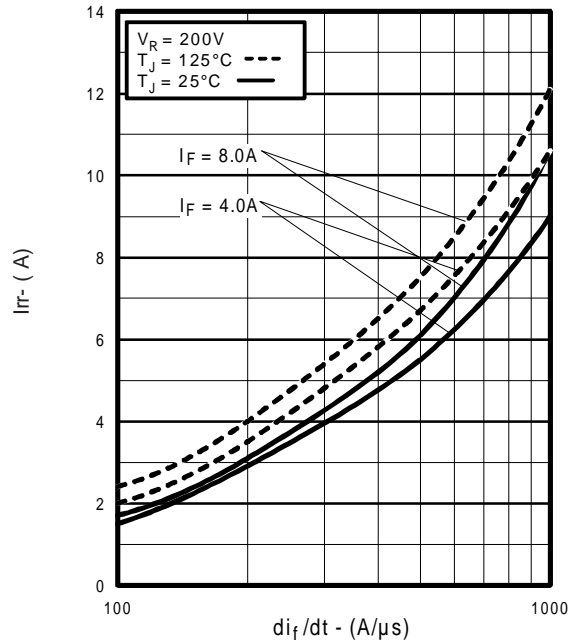

Fig. 15 - Typical Recovery Current vs. di_f/dt

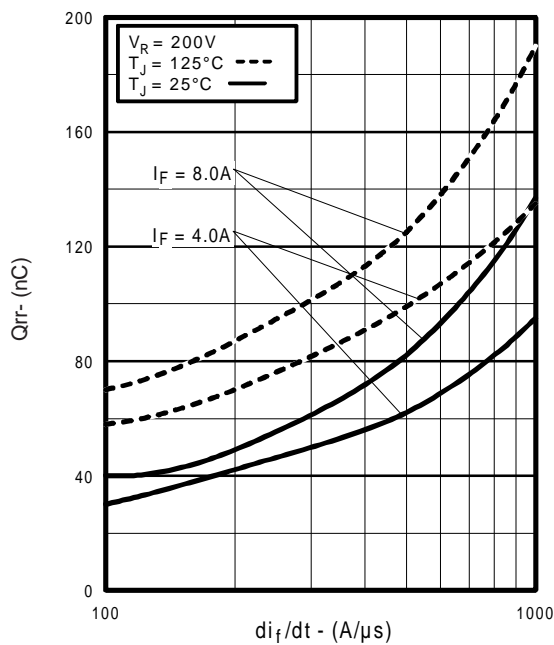

Fig. 16 - Typical Stored Charge vs. di_f/dt

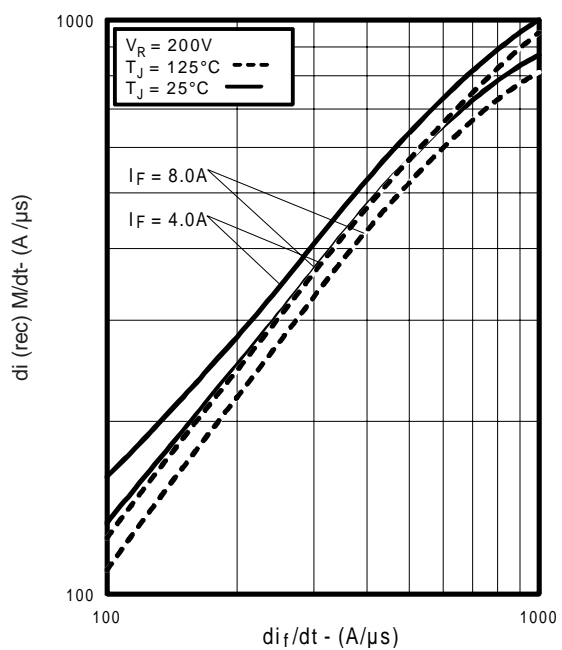

Fig. 17 - Typical $di_{(rec)M}/dt$ vs. di_f/dt ,

IRG4BC15MD

International
IR Rectifier

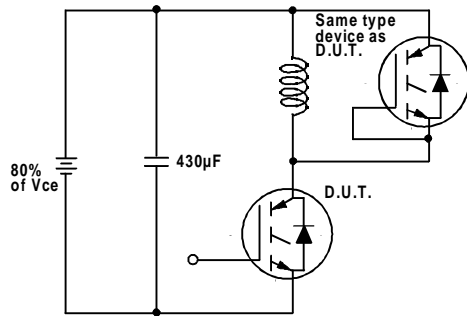

Fig. 18a - Test Circuit for Measurement of I_{LM} , E_{on} , $E_{off}(\text{diode})$, t_{rr} , Q_{rr} , I_{rr} , $t_{d(on)}$, t_r , $t_{d(off)}$, t_f

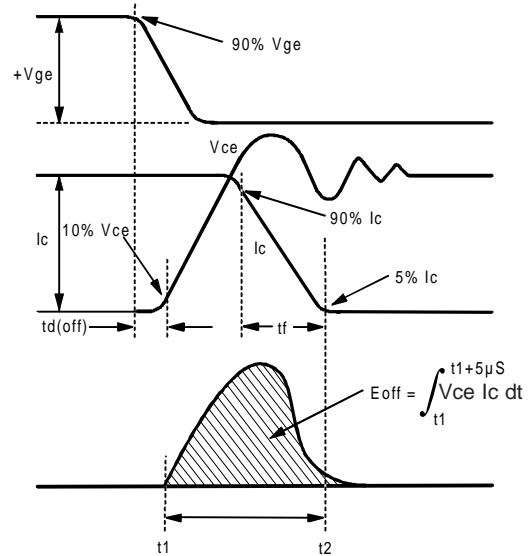

Fig. 18b - Test Waveforms for Circuit of Fig. 18a, Defining E_{off} , $t_{d(off)}$, t_f

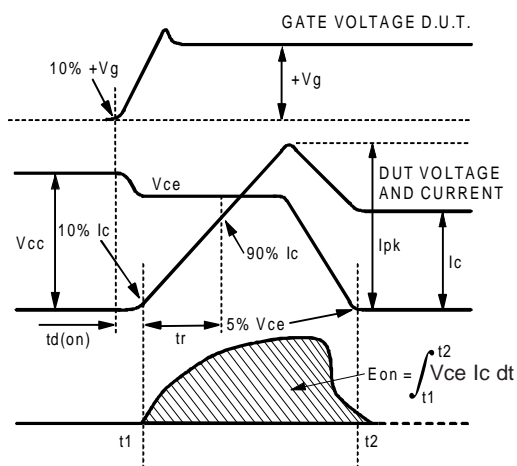

Fig. 18c - Test Waveforms for Circuit of Fig. 18a, Defining E_{on} , $t_{d(on)}$, t_r

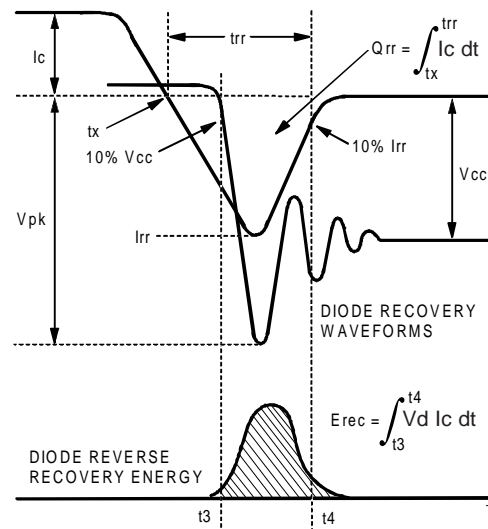

Fig. 18d - Test Waveforms for Circuit of Fig. 18a, Defining E_{rec} , t_{rr} , Q_{rr} , I_{rr}

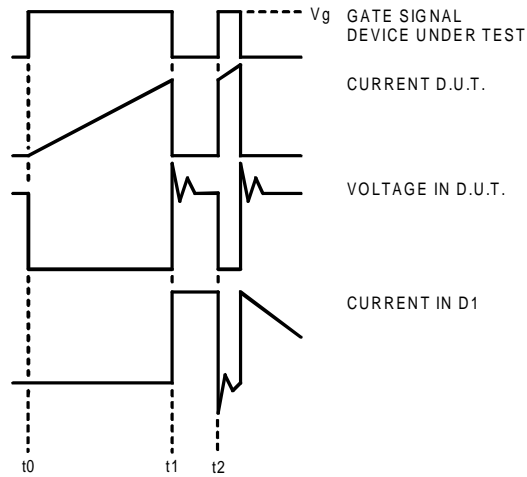

Figure 18e. Macro Waveforms for Figure 18a's Test Circuit

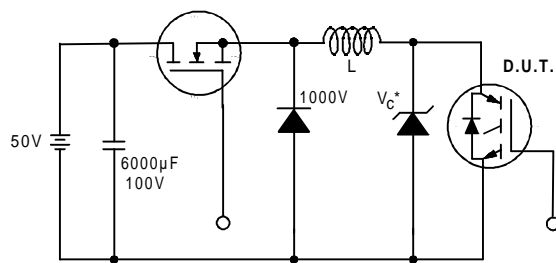

Figure 19. Clamped Inductive Load Test Circuit

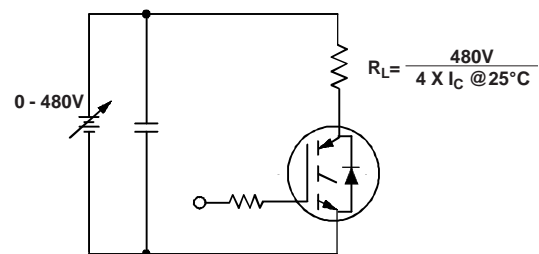

Figure 20. Pulsed Collector Current Test Circuit

IRG4BC15MD

International
IR Rectifier

Notes:

- ① Repetitive rating: $V_{GE}=20V$; pulse width limited by maximum junction temperature
- ② $V_{CC}=80\%(V_{CES})$, $V_{GE}=20V$, $L=10\mu H$, $R_G = 75\Omega$
- ③ Pulse width $\leq 80\mu s$; duty factor $\leq 0.1\%$.
- ④ Pulse width $5.0\mu s$, single shot.

Case Outline — TO-220AB

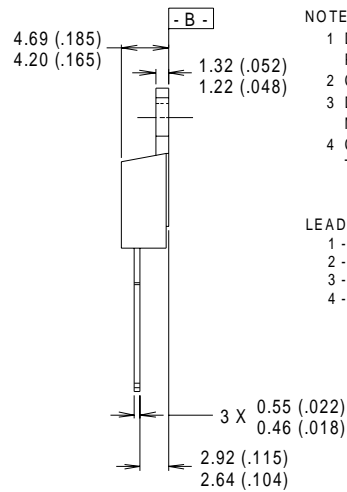
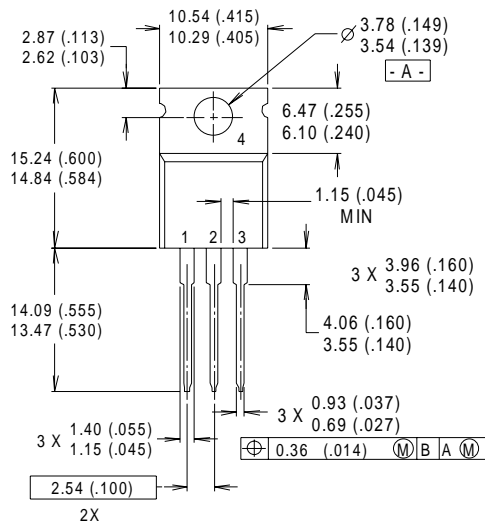

- NOTES:
- 1 DIMENSIONS & TOLERANCING PER ANSI Y14.5M, 1982.
 - 2 CONTROLLING DIMENSION : INCH.
 - 3 DIMENSIONS ARE SHOWN MILLIMETERS (INCHES).
 - 4 CONFORMS TO JEDEC OUTLINE TO-220AB.

LEAD ASSIGNMENTS

- 1 - GATE
- 2 - COLLECTOR
- 3 - EMITTER
- 4 - COLLECTOR

CONFORMS TO JEDEC OUTLINE TO-220AB

Dimensions in Millimeters and (Inches)

Data and specifications subject to change without notice.
This product has been designed and qualified for the industrial market.
Qualification Standards can be found on IR's Web site.

International
IR Rectifier

IR WORLD HEADQUARTERS: 233 Kansas St., El Segundo, California 90245, USA Tel: (310) 252-7105
TAC Fax: (310) 252-7903

Visit us at www.irf.com for sales contact information.05/01

Note: For the most current drawings please refer to the IR website at:
<http://www.irf.com/package/>