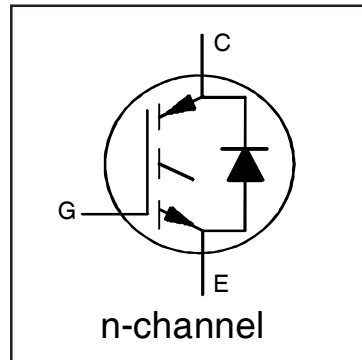


# IRGPS4067DPbF

## INSULATED GATE BIPOLAR TRANSISTOR WITH ULTRAFAST SOFT RECOVERY DIODE

### Features

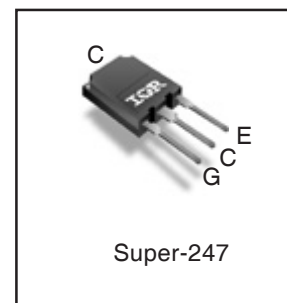
- Low  $V_{CE(on)}$  Trench IGBT Technology
- Low Switching Losses
- 5 $\mu$ s SCSOA
- Square RBSOA
- 100% of The Parts Tested for  $I_{LM}$  ①
- Positive  $V_{CE(on)}$  Temperature Coefficient.
- Ultra Fast Soft Recovery Co-pak Diode
- Tighter Distribution of Parameters
- Lead-Free, RoHS Compliant



$V_{CES} = 600V$
$I_{C(Nominal)} = 120A$
$t_{SC} \geq 5\mu s, T_{J(max)} = 175^{\circ}C$
$V_{CE(on)} \text{ typ.} = 1.70V$

### Benefits

- High Efficiency in a Wide Range of Applications
- Suitable for a Wide Range of Switching Frequencies due to Low  $V_{CE(ON)}$  and Low Switching Losses
- Rugged Transient Performance for Increased Reliability
- Excellent Current Sharing in Parallel Operation
- Low EMI



<b>G</b>	<b>C</b>	<b>E</b>
Gate	Collector	Emitter

### Absolute Maximum Ratings

	Parameter	Max.	Units	
$V_{CES}$	Collector-to-Emitter Voltage	600	V	
$I_C @ T_C = 25^{\circ}C$	Continuous Collector Current	240 <sup>③</sup>	A	
$I_C @ T_C = 100^{\circ}C$	Continuous Collector Current	160 <sup>③</sup>		
$I_{NOMINAL}$	Nominal Current	120		
$I_{CM}$	Pulse Collector Current, $V_{GE} = 15V$	360		
$I_{LM}$	Clamped Inductive Load Current, $V_{GE} = 20V$ ①	480		
$I_F @ T_C = 25^{\circ}C$	Diode Continuous Forward Current	240		
$I_F @ T_C = 100^{\circ}C$	Diode Continuous Forward Current	160		
$I_{FM}$	Diode Maximum Forward Current ②	480		
$V_{GE}$	Continuous Gate-to-Emitter Voltage	$\pm 20$		V
	Transient Gate-to-Emitter Voltage	$\pm 30$		
$P_D @ T_C = 25^{\circ}C$	Maximum Power Dissipation	750	W	
		375		
$T_J$ $T_{STG}$	Operating Junction and Storage Temperature Range	-55 to +175	$^{\circ}C$	
		Soldering Temperature, for 10 sec.		300 (0.063 in. (1.6mm) from case)

### Thermal Resistance

	Parameter	Min.	Typ.	Max.	Units
$R_{\theta JC}$ (IGBT)	Thermal Resistance Junction-to-Case-(each IGBT) ④	—	—	0.20	$^{\circ}C/W$
$R_{\theta JC}$ (Diode)	Thermal Resistance Junction-to-Case-(each Diode) ④	—	—	0.63	
$R_{\theta CS}$	Thermal Resistance, Case-to-Sink (flat, greased surface)	—	0.24	—	
$R_{\theta JA}$	Thermal Resistance, Junction-to-Ambient (typical socket mount)	—	—	40	

## Electrical Characteristics @ T<sub>J</sub> = 25°C (unless otherwise specified)

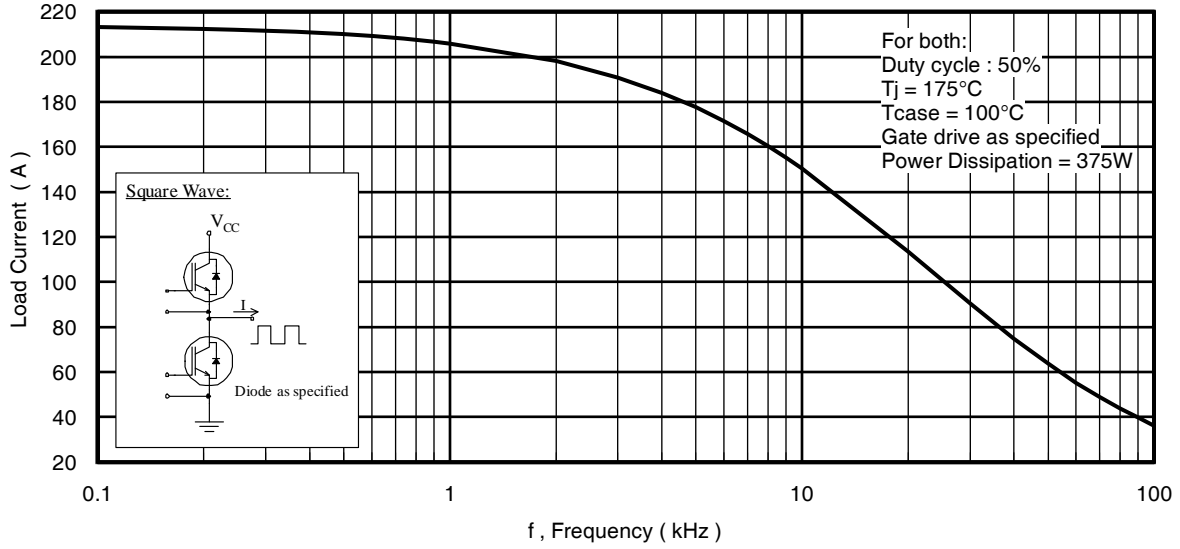
	Parameter	Min.	Typ.	Max.	Units	Conditions
V <sub>(BR)CES</sub>	Collector-to-Emitter Breakdown Voltage	600	—	—	V	V <sub>GE</sub> = 0V, I <sub>C</sub> = 100μA <sup>③</sup>
ΔV <sub>(BR)CES</sub> /ΔT <sub>J</sub>	Temperature Coeff. of Breakdown Voltage	—	0.27	—	V/°C	V <sub>GE</sub> = 0V, I <sub>C</sub> = 4.0mA (25°C-175°C)
V <sub>CE(on)</sub>	Collector-to-Emitter Saturation Voltage	—	1.70	2.05	V	I <sub>C</sub> = 120A, V <sub>GE</sub> = 15V, T <sub>J</sub> = 25°C
		—	2.15	—		I <sub>C</sub> = 120A, V <sub>GE</sub> = 15V, T <sub>J</sub> = 150°C
		—	2.20	—		I <sub>C</sub> = 120A, V <sub>GE</sub> = 15V, T <sub>J</sub> = 175°C
V <sub>GE(th)</sub>	Gate Threshold Voltage	4.0	—	6.5	V	V <sub>CE</sub> = V <sub>GE</sub> , I <sub>C</sub> = 5.6mA
ΔV <sub>GE(th)</sub> /ΔT <sub>J</sub>	Threshold Voltage temp. coefficient	—	-17	—	mV/°C	V <sub>CE</sub> = V <sub>GE</sub> , I <sub>C</sub> = 5.6mA (25°C - 175°C)
g <sub>fe</sub>	Forward Transconductance	—	77	—	S	V <sub>CE</sub> = 50V, I <sub>C</sub> = 120A
I <sub>CES</sub>	Collector-to-Emitter Leakage Current	—	1.0	150	μA	V <sub>GE</sub> = 0V, V <sub>CE</sub> = 600V
		—	2.3	—	mA	V <sub>GE</sub> = 0V, V <sub>CE</sub> = 600V, T <sub>J</sub> = 175°C
V <sub>FM</sub>	Diode Forward Voltage Drop	—	2.4	3.0	V	I <sub>F</sub> = 120A
		—	1.9	—	—	I <sub>F</sub> = 120A, T <sub>J</sub> = 175°C
I <sub>GES</sub>	Gate-to-Emitter Leakage Current	—	—	±400	nA	V <sub>GE</sub> = ±20V

## Switching Characteristics @ T<sub>J</sub> = 25°C (unless otherwise specified)

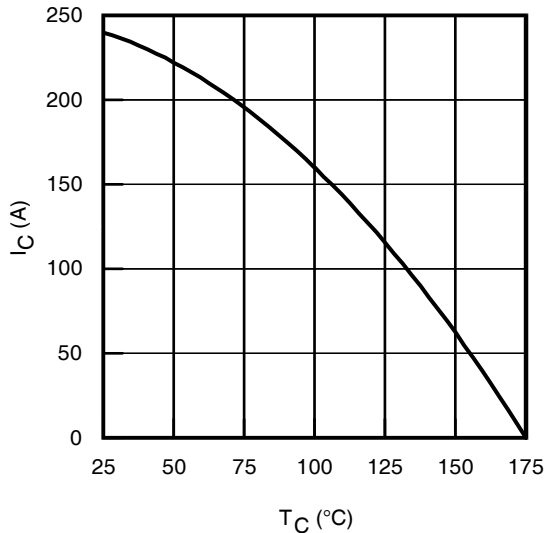
	Parameter	Min.	Typ.	Max. ⑥	Units	Conditions
Q <sub>g</sub>	Total Gate Charge (turn-on)	—	240	360	nC	I <sub>C</sub> = 120A
Q <sub>ge</sub>	Gate-to-Emitter Charge (turn-on)	—	70	105		V <sub>GE</sub> = 15V
Q <sub>gc</sub>	Gate-to-Collector Charge (turn-on)	—	90	135		V <sub>CC</sub> = 400V
E <sub>on</sub>	Turn-On Switching Loss	—	5750	7990	μJ	I <sub>C</sub> = 120A, V <sub>CC</sub> = 400V, V <sub>GE</sub> = 15V
E <sub>off</sub>	Turn-Off Switching Loss	—	3430	4360		R <sub>G</sub> = 4.7Ω, L = 66μH, T <sub>J</sub> = 25°C
E <sub>total</sub>	Total Switching Loss	—	9180	12350		Energy losses include tail & diode reverse recovery
t <sub>d(on)</sub>	Turn-On delay time	—	80	100	ns	I <sub>C</sub> = 120A, V <sub>CC</sub> = 400V, V <sub>GE</sub> = 15V
t <sub>r</sub>	Rise time	—	70	125		R <sub>G</sub> = 4.7Ω, L = 66μH, T <sub>J</sub> = 25°C
t <sub>d(off)</sub>	Turn-Off delay time	—	190	220		
t <sub>f</sub>	Fall time	—	40	60		
E <sub>on</sub>	Turn-On Switching Loss	—	7740	—		μJ
E <sub>off</sub>	Turn-Off Switching Loss	—	4390	—	R <sub>G</sub> = 4.7Ω, L = 66μH, T <sub>J</sub> = 175°C	
E <sub>total</sub>	Total Switching Loss	—	12130	—	Energy losses include tail & diode reverse recovery	
t <sub>d(on)</sub>	Turn-On delay time	—	80	—	ns	I <sub>C</sub> = 120A, V <sub>CC</sub> = 400V, V <sub>GE</sub> = 15V
t <sub>r</sub>	Rise time	—	75	—		R <sub>G</sub> = 4.7Ω, L = 66μH
t <sub>d(off)</sub>	Turn-Off delay time	—	230	—		T <sub>J</sub> = 175°C
t <sub>f</sub>	Fall time	—	55	—		
C <sub>ies</sub>	Input Capacitance	—	7750	—		pF
C <sub>oes</sub>	Output Capacitance	—	550	—	V <sub>CC</sub> = 30V	
C <sub>res</sub>	Reverse Transfer Capacitance	—	225	—	f = 1.0Mhz	
RBSOA	Reverse Bias Safe Operating Area	FULL SQUARE				T <sub>J</sub> = 175°C, I <sub>C</sub> = 480A V <sub>CC</sub> = 480V, V <sub>p</sub> = 600V R <sub>G</sub> = 4.7Ω, V <sub>GE</sub> = +20V to 0V
SCSOA	Short Circuit Safe Operating Area	5	—	—	μs	V <sub>CC</sub> = 400V, V <sub>p</sub> = 600V R <sub>G</sub> = 4.7Ω, V <sub>GE</sub> = +15V to 0V
E <sub>rec</sub>	Reverse Recovery Energy of the Diode	—	500	—	μJ	T <sub>J</sub> = 175°C
t <sub>rr</sub>	Diode Reverse Recovery Time	—	130	—	ns	V <sub>CC</sub> = 400V, I <sub>F</sub> = 120A
I <sub>rr</sub>	Peak Reverse Recovery Current	—	36	—	A	V <sub>GE</sub> = 15V, R <sub>G</sub> = 4.7Ω, L = 100μH

### Notes:

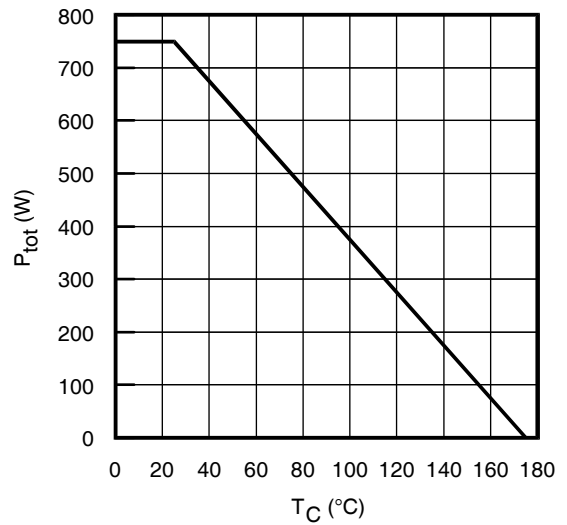
- ① V<sub>CC</sub> = 80% (V<sub>CES</sub>), V<sub>GE</sub> = 20V, L = 66μH, R<sub>G</sub> = 4.7Ω, tested in production I<sub>LM</sub> ≤ 400A.
- ② Pulse width limited by max. junction temperature.
- ③ Refer to AN-1086 for guidelines for measuring V<sub>(BR)CES</sub> safely.
- ④ R<sub>θ</sub> is measured at T<sub>J</sub> of approximately 90°C.
- ⑤ Calculated continuous current based on maximum allowable junction temperature. Package IGBT current limit is 195A. Package diode current limit is 120A. Note that current limitations arising from heating of the device leads may occur.
- ⑥ Maximum limits are based on statistical sample size characterization.



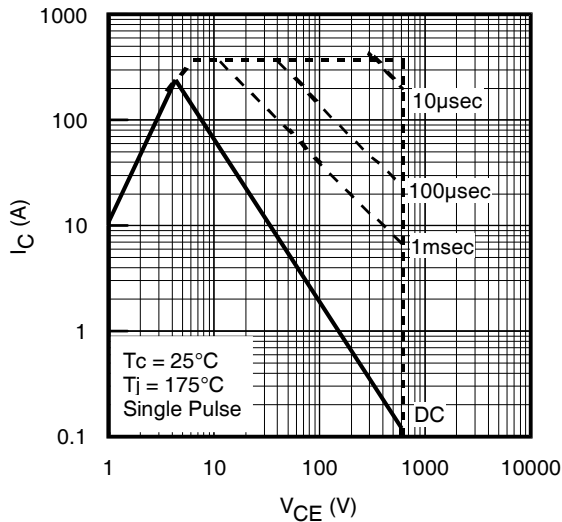
**Fig. 1 - Typical Load Current vs. Frequency**  
(Load Current =  $I_{RMS}$  of fundamental)



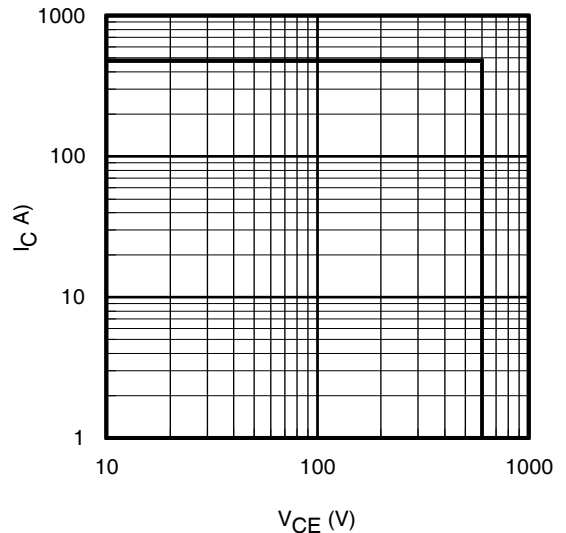
**Fig. 2 - Maximum DC Collector Current vs. Case Temperature**



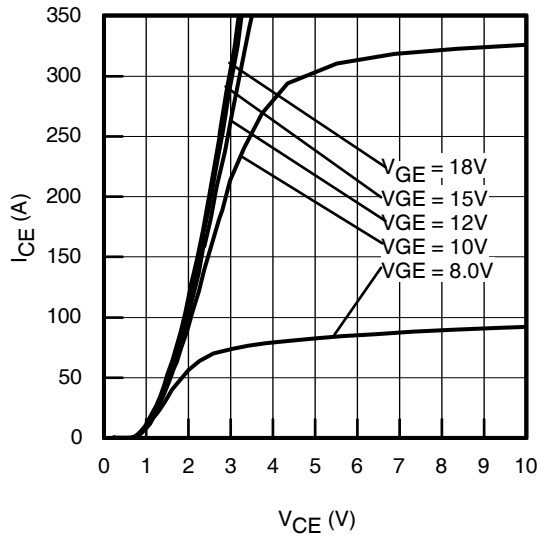
**Fig. 3 - Power Dissipation vs. Case Temperature**



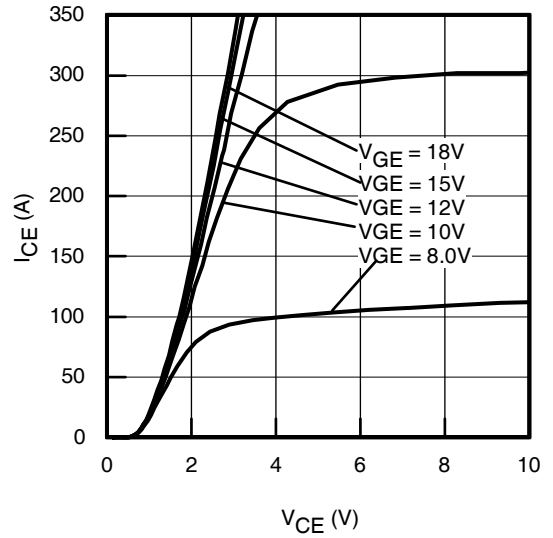
**Fig. 4 - Forward SOA**  
 $T_C = 25^\circ\text{C}$ ,  $T_J \leq 175^\circ\text{C}$ ;  $V_{GE} = 15\text{V}$



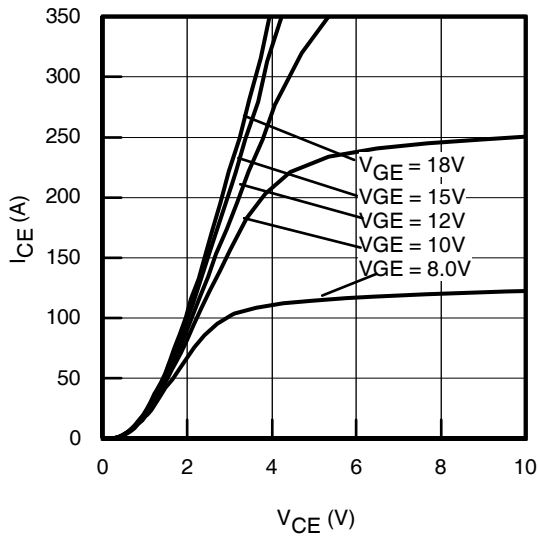
**Fig. 5 - Reverse Bias SOA**  
 $T_J = 175^\circ\text{C}$ ;  $V_{GE} = 20\text{V}$



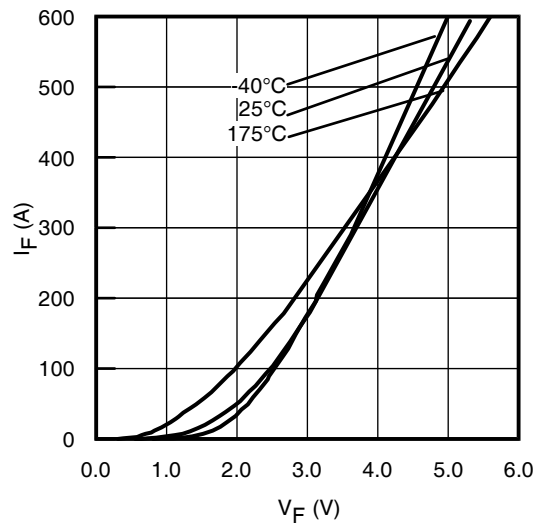
**Fig. 6** - Typ. IGBT Output Characteristics  
 $T_J = -40^\circ\text{C}$ ;  $t_p = 80\mu\text{s}$



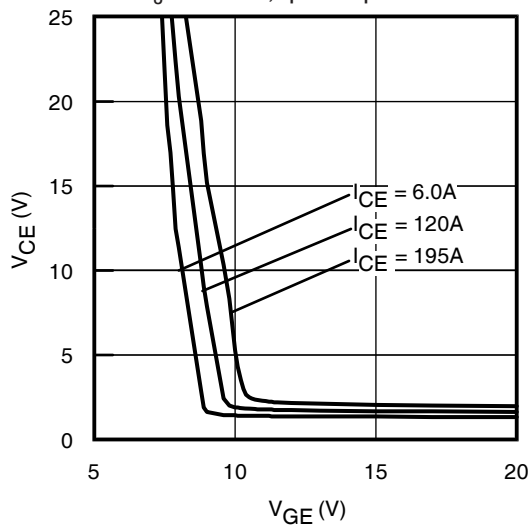
**Fig. 7** - Typ. IGBT Output Characteristics  
 $T_J = 25^\circ\text{C}$ ;  $t_p = 80\mu\text{s}$



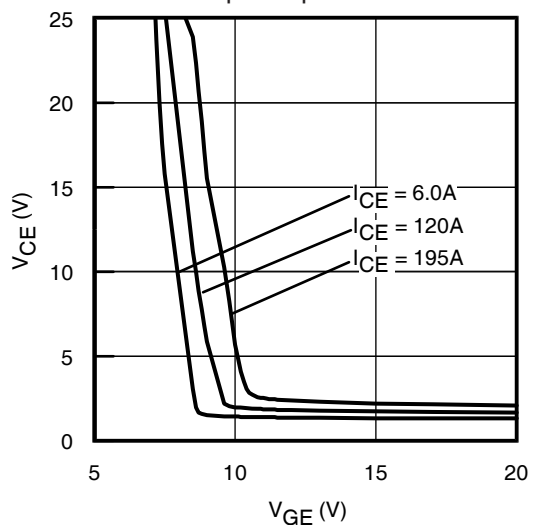
**Fig. 8** - Typ. IGBT Output Characteristics  
 $T_J = 175^\circ\text{C}$ ;  $t_p = 80\mu\text{s}$



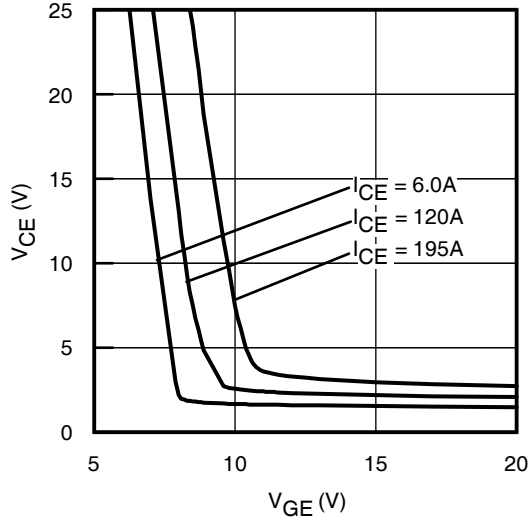
**Fig. 9** - Typ. Diode Forward Characteristics  
 $t_p = 80\mu\text{s}$



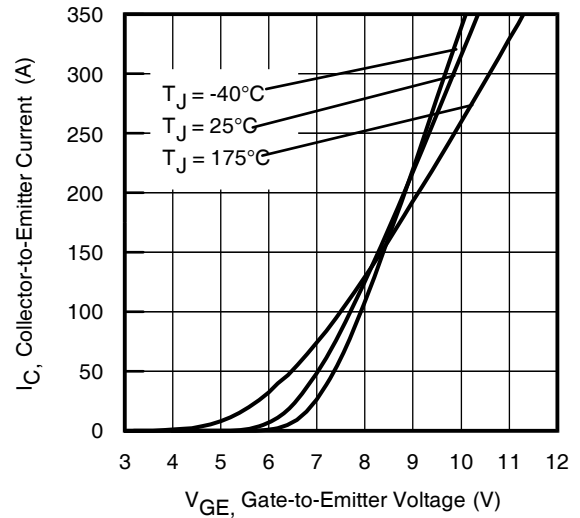
**Fig. 10** - Typical  $V_{CE}$  vs.  $V_{GE}$   
 $T_J = -40^\circ\text{C}$



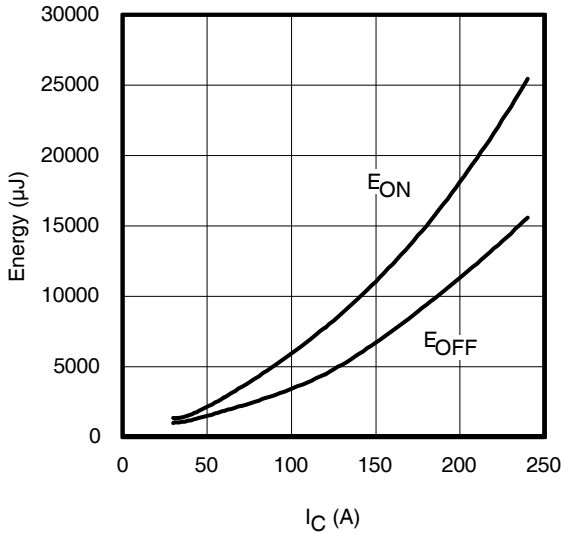
**Fig. 11** - Typical  $V_{CE}$  vs.  $V_{GE}$   
 $T_J = 25^\circ\text{C}$



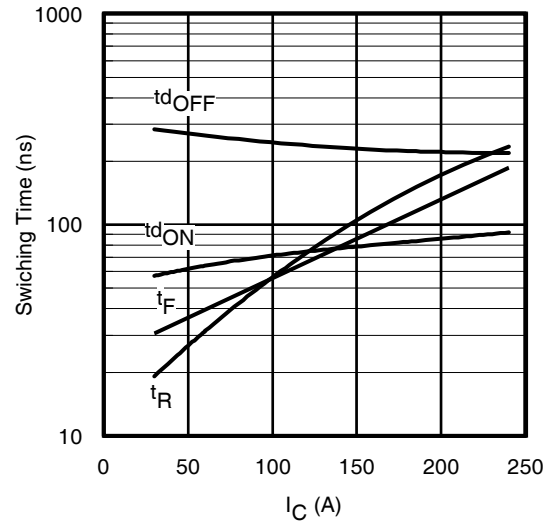
**Fig. 12** - Typical  $V_{CE}$  vs.  $V_{GE}$   
 $T_J = 175^\circ\text{C}$



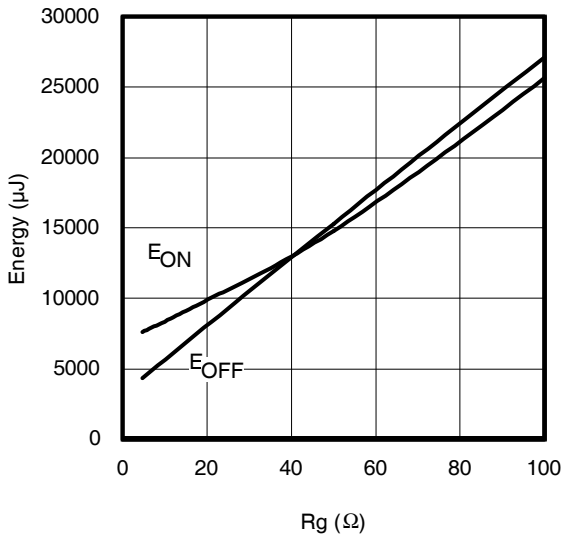
**Fig. 13** - Typ. Transfer Characteristics  
 $V_{CE} = 50\text{V}$ ;  $t_p = 10\mu\text{s}$



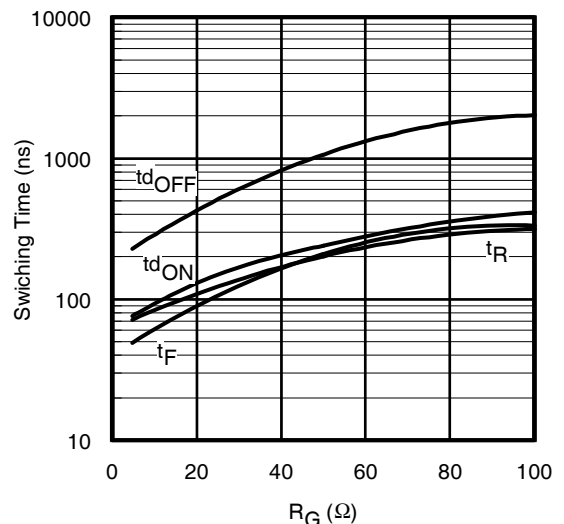
**Fig. 14** - Typ. Energy Loss vs.  $I_C$   
 $T_J = 175^\circ\text{C}$ ;  $L = 66\mu\text{H}$ ;  $V_{CE} = 400\text{V}$ ;  $R_G = 4.7\Omega$ ;  $V_{GE} = 15\text{V}$



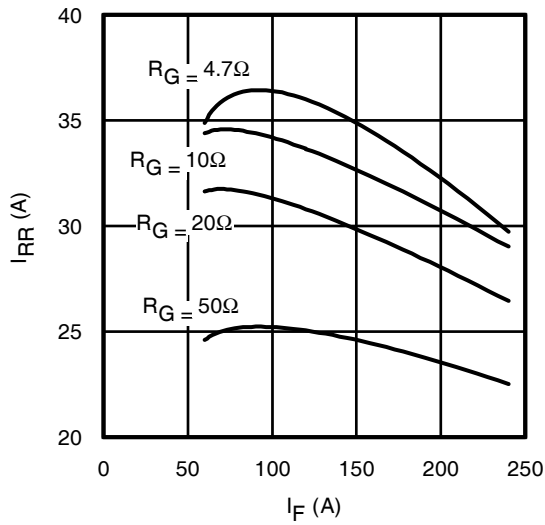
**Fig. 15** - Typ. Switching Time vs.  $I_C$   
 $T_J = 175^\circ\text{C}$ ;  $L = 66\mu\text{H}$ ;  $V_{CE} = 400\text{V}$ ;  $R_G = 4.7\Omega$ ;  $V_{GE} = 15\text{V}$



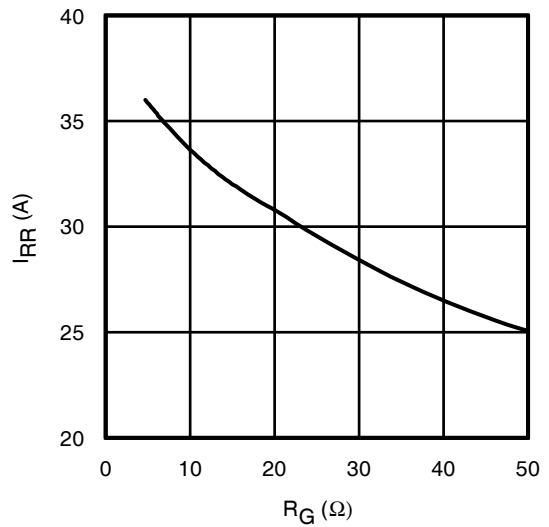
**Fig. 16** - Typ. Energy Loss vs.  $R_G$   
 $T_J = 175^\circ\text{C}$ ;  $L = 66\mu\text{H}$ ;  $V_{CE} = 400\text{V}$ ;  $I_{CE} = 120\text{A}$ ;  $V_{GE} = 15\text{V}$



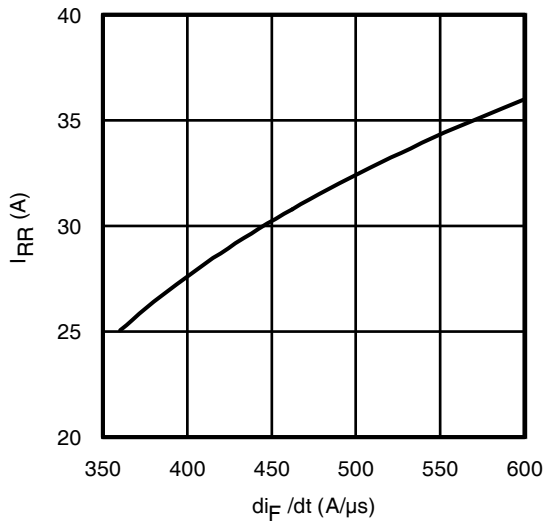
**Fig. 17** - Typ. Switching Time vs.  $R_G$   
 $T_J = 175^\circ\text{C}$ ;  $L = 66\mu\text{H}$ ;  $V_{CE} = 400\text{V}$ ;  $I_{CE} = 120\text{A}$ ;  $V_{GE} = 15\text{V}$



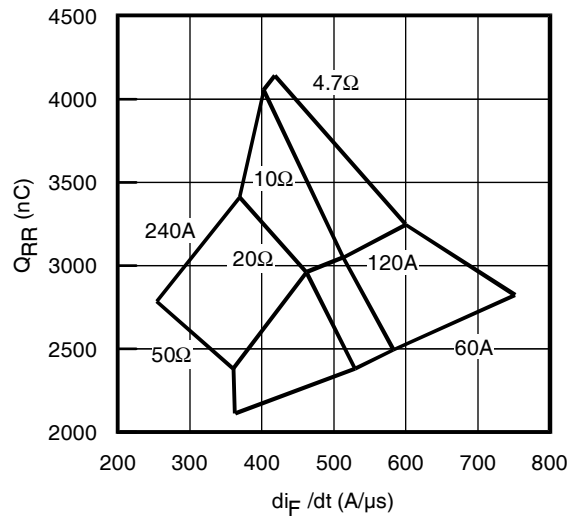
**Fig. 18** - Typ. Diode  $I_{RR}$  vs.  $I_F$   
 $T_J = 175^\circ\text{C}$



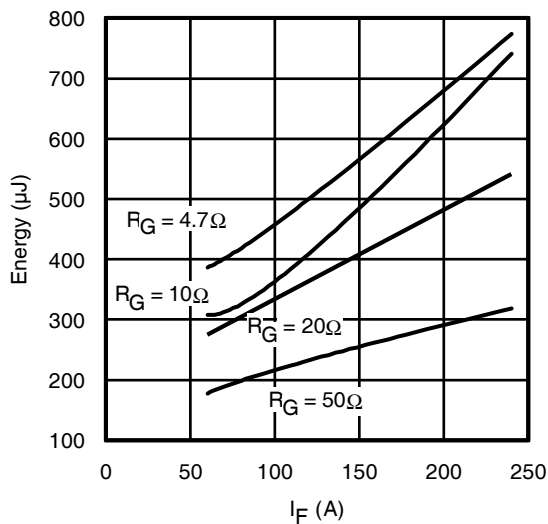
**Fig. 19** - Typ. Diode  $I_{RR}$  vs.  $R_G$   
 $T_J = 175^\circ\text{C}$



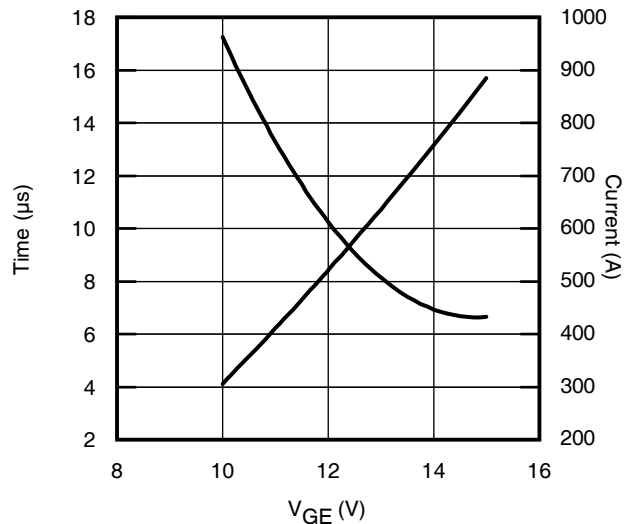
**Fig. 20** - Typ. Diode  $I_{RR}$  vs.  $di_F/dt$   
 $V_{CC} = 400\text{V}$ ;  $V_{GE} = 15\text{V}$ ;  $I_F = 120\text{A}$ ;  $T_J = 175^\circ\text{C}$



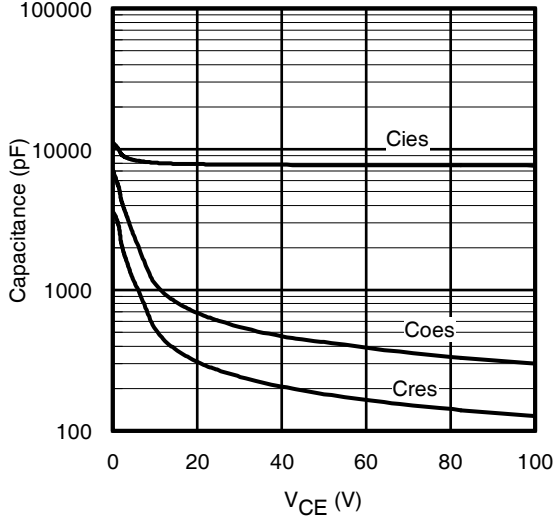
**Fig. 21** - Typ. Diode  $Q_{RR}$  vs.  $di_F/dt$   
 $V_{CC} = 400\text{V}$ ;  $V_{GE} = 15\text{V}$ ;  $T_J = 175^\circ\text{C}$



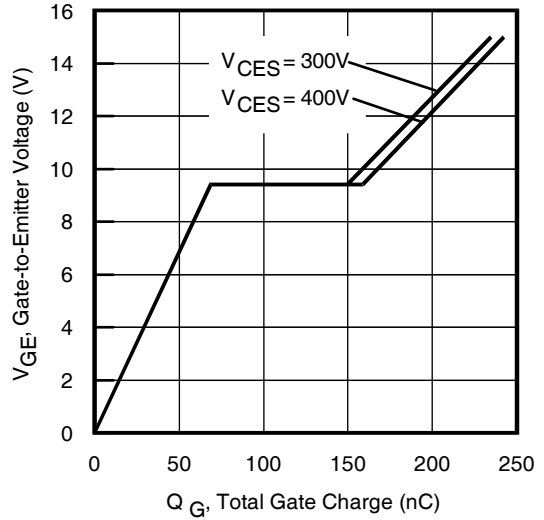
**Fig. 22** - Typ. Diode  $E_{RR}$  vs.  $I_F$   
 $T_J = 175^\circ\text{C}$



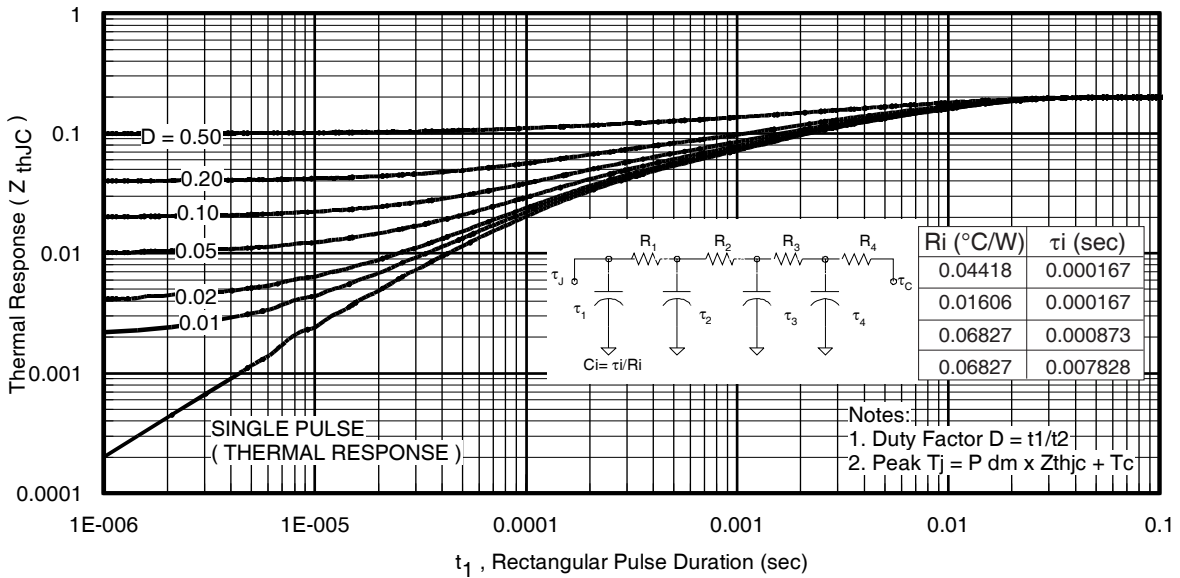
**Fig. 23** -  $V_{GE}$  vs. Short Circuit Time  
 $V_{CC} = 400\text{V}$ ;  $T_C = 25^\circ\text{C}$



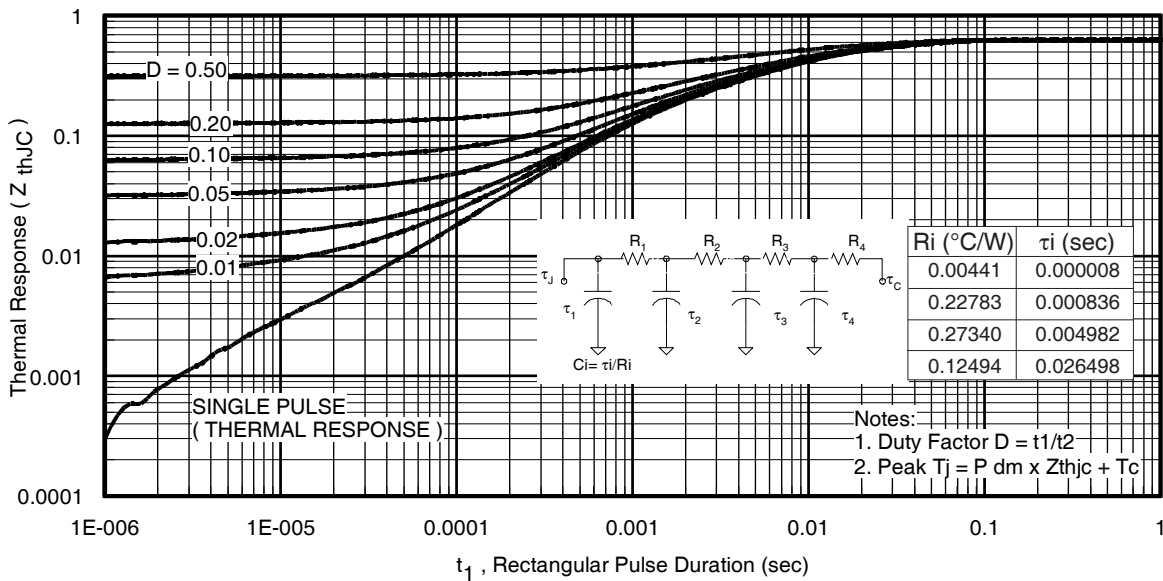
**Fig. 24** - Typ. Capacitance vs.  $V_{CE}$   
 $V_{GE} = 0V$ ;  $f = 1MHz$



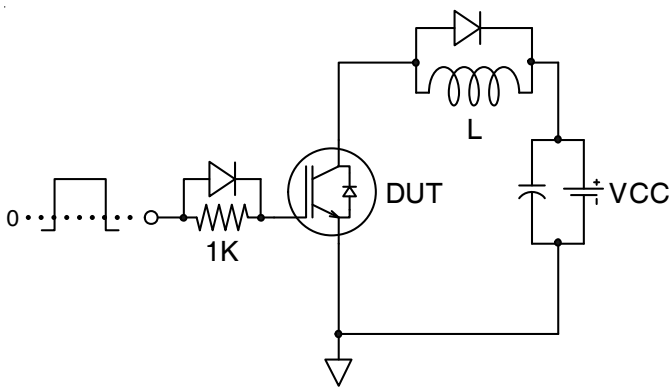
**Fig. 25** - Typical Gate Charge vs.  $V_{GE}$   
 $I_{CE} = 120A$ ;  $L = 100\mu H$



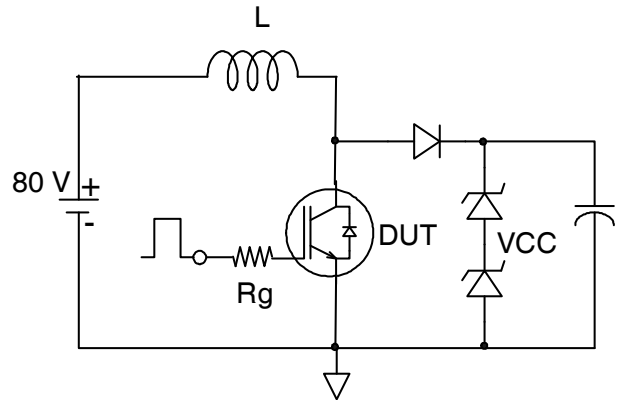
**Fig. 26.** Maximum Transient Thermal Impedance, Junction-to-Case (IGBT)



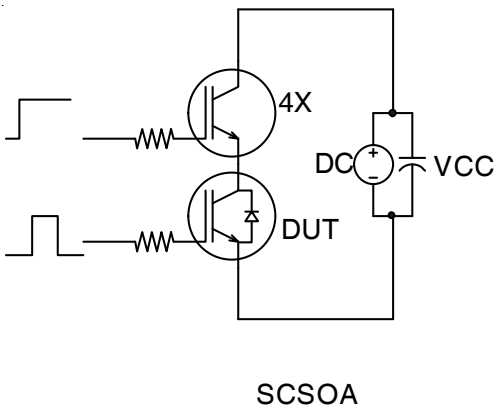
**Fig. 27.** Maximum Transient Thermal Impedance, Junction-to-Case (DIODE)



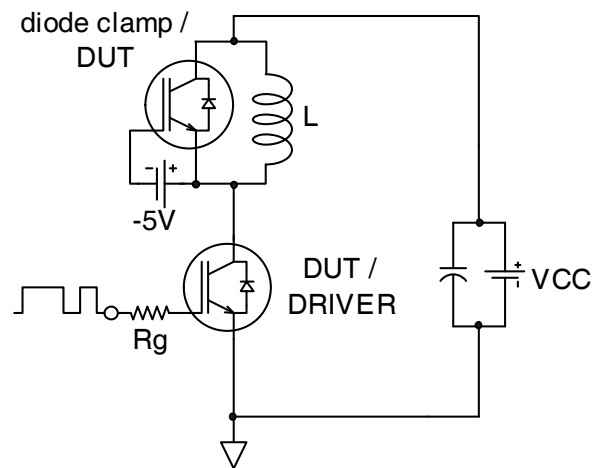
**Fig.C.T.1 - Gate Charge Circuit (turn-off)**



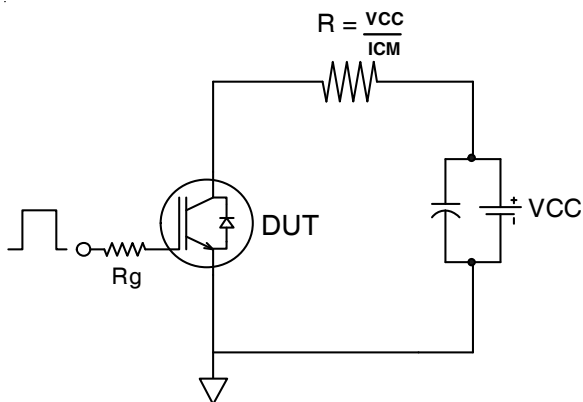
**Fig.C.T.2 - RBSOA Circuit**



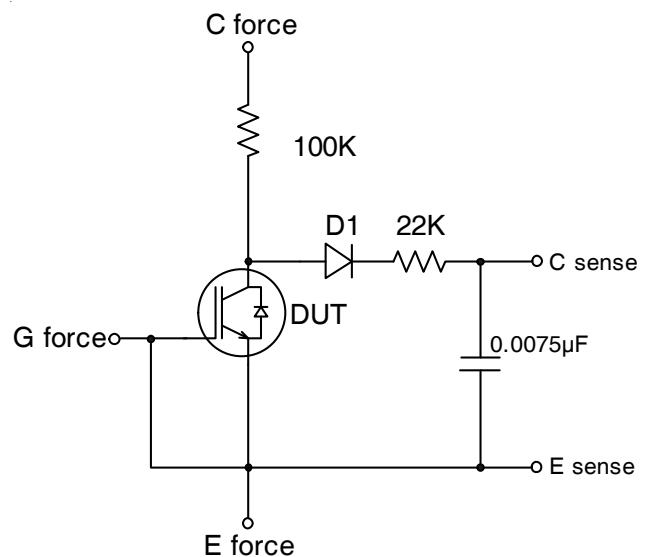
**Fig.C.T.3 - S.C. SOA Circuit**



**Fig.C.T.4 - Switching Loss Circuit**

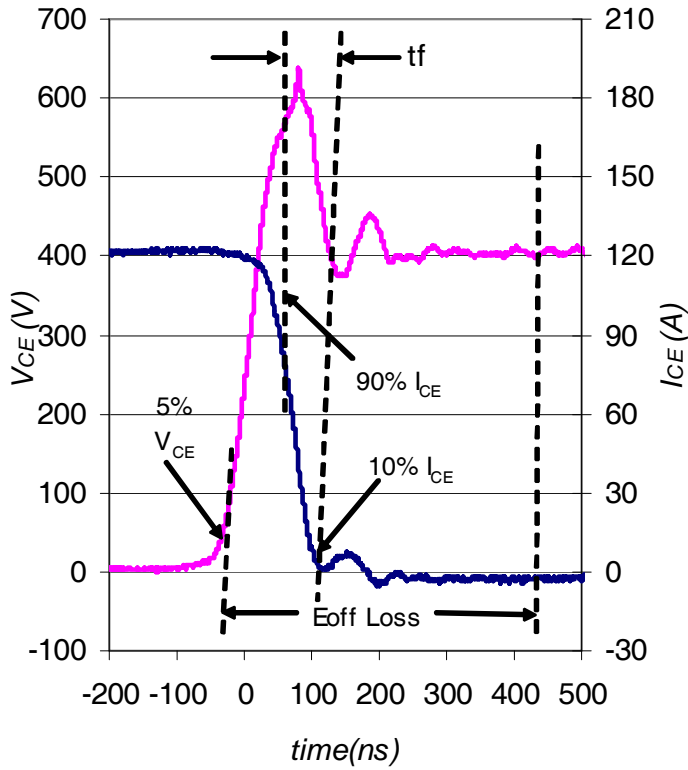


**Fig.C.T.5 - Resistive Load Circuit**

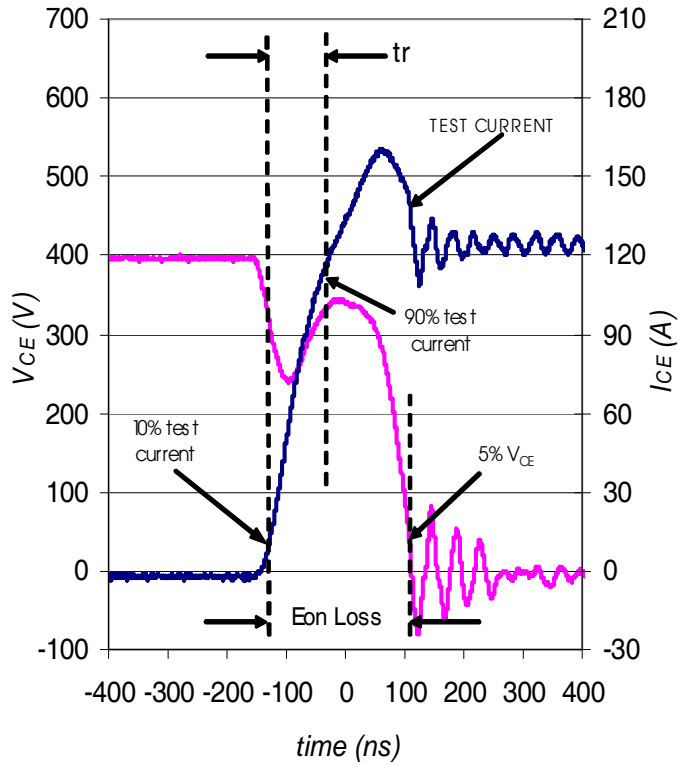


**Fig.C.T.6 - BVCES Filter Circuit**

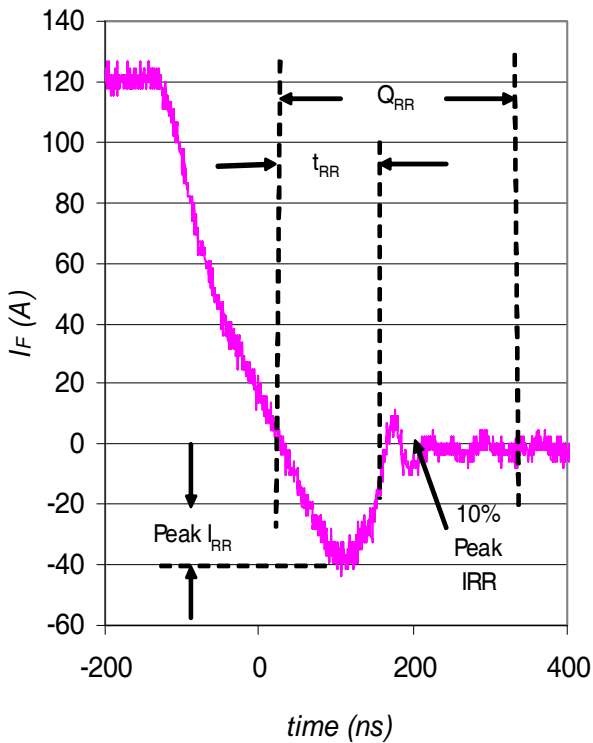




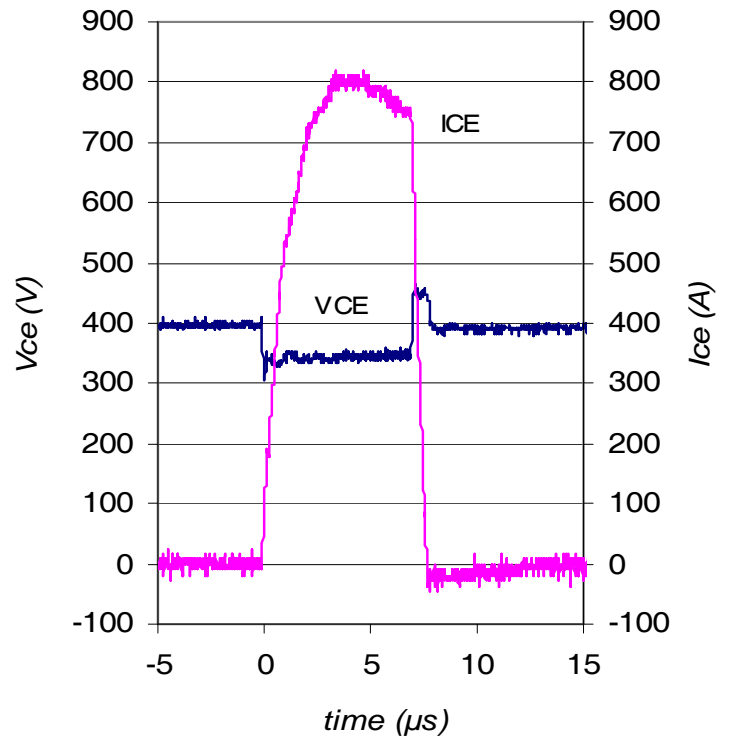
**Fig. WF1** - Typ. Turn-off Loss Waveform  
@  $T_J = 175^\circ\text{C}$  using Fig. CT.4



**Fig. WF2** - Typ. Turn-on Loss Waveform  
@  $T_J = 175^\circ\text{C}$  using Fig. CT.4

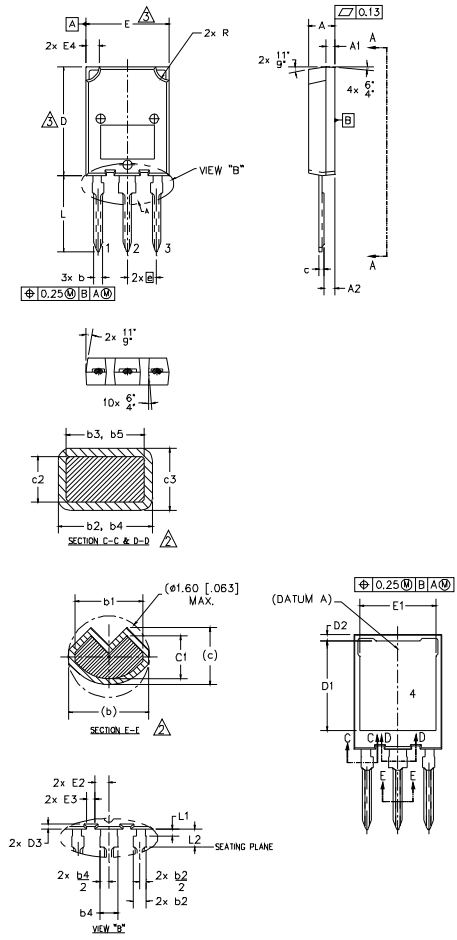


**Fig. WF3** - Typ. Diode Recovery Waveform  
@  $T_J = 175^\circ\text{C}$  using Fig. CT.4



**Fig. WF4** - Typ. S.C. Waveform  
@  $T_J = 25^\circ\text{C}$  using Fig. CT.3

## Case Outline and Dimensions — Super-247



- NOTES:
1. DIMENSIONING AND TOLERANCING AS PER ASME Y14.5M-1994
  2. DIMENSIONS b1, b3, b5, c1 & c3 APPLY TO BASE METAL ONLY.
  3. DIMENSION D & E DO NOT INCLUDE MOLD FLASH. MOLD FLASH SHALL NOT EXCEED 0.127 [.005"] PER SIDE. THESE DIMENSIONS ARE MEASURED AT THE OUTER EXTREMES OF THE PLASTIC BODY.
  - 4.- ALL DIMENSIONS SHOWN IN MILLIMETERS.
  - 5.- CONTROLLING DIMENSION: MILLIMETER.
  - 6.- OUTLINE CONFORMS TO JEDEC OUTLINE TO-274AA

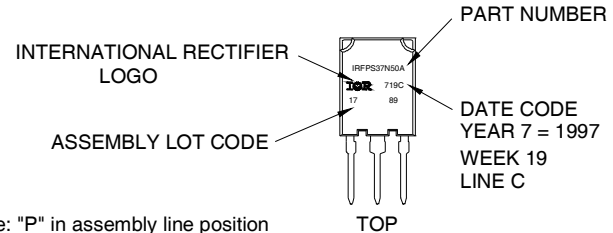
SYMBOL	DIMENSIONS				NOTES
	MILLIMETERS		INCHES		
	MIN.	MAX.	MIN.	MAX.	
A	4.50	5.50	.177	.217	
A1	1.45	2.15	.057	.085	
A2	1.65	2.35	.065	.093	
b	1.45	1.60	.054	.063	
b1	1.40	1.50	.055	.059	2
b2	2.00	2.40	.079	.094	
b3	1.95	2.35	.077	.093	2
b4	3.00	3.15	.118	.124	
b5	2.95	3.35	.116	.132	2
c	1.10	1.30	.043	.051	
c1	0.90	1.10	.035	.043	2
c2	0.65	0.85	.026	.033	
c3	0.50	0.70	.020	.028	2
D	19.80	20.80	.780	.819	3
D1	15.50	16.10	.610	.634	
D2	0.70	1.30	.028	.051	
D3	0.75	1.25	.030	.049	
E	15.10	16.10	.594	.634	3
E1	13.30	13.90	.524	.547	
E2	2.25	2.70	.089	.109	
E3	1.20	1.70	.047	.067	
E4	2.00	3.00	.079	.118	
e	5.45 BSC		.215 BSC		
L	13.80	14.80	.535	.583	
L1	1.00	1.60	.039	.063	
L2	3.85	4.25	.152	.167	
R	2.00	3.00	.079	.118	

**LEAD ASSIGNMENTS**

- MOSFET**
- 1.- GATE
  - 2.- DRAIN
  - 3.- SOURCE
  - 4.- DRAIN
- IGBT**
- 1.- GATE
  - 2.- COLLECTOR
  - 3.- EMITTER
  - 4.- COLLECTOR

## Super-247 (TO-274AA) Part Marking Information

EXAMPLE: THIS IS AN IRFPS37N50A WITH  
ASSEMBLY LOT CODE 1789  
ASSEMBLED ON WW 19, 1997  
IN THE ASSEMBLY LINE "C"



Note: "P" in assembly line position indicates "Lead-Free"

Note: For the most current drawing please refer to IR website at <http://www.irf.com/package/>

Data and specifications subject to change without notice.  
This product has been designed and qualified for Industrial market.  
Qualification Standards can be found on IR's Web site.