

GT Series Sealed Ultraminiature Toggle Switches

Features/Benefits

- Sealed against solder and cleaning process contaminants
- Ultraminiature size, smallest footprint available
- Thru-hole and surface mount models
- High temperature materials (UL 94V-0)
- RoHS compliant and compatible

Typical Applications

- Hand-held telecommunications
- Small instrumentation



Specifications

CONTACT RATING: 0.4 VA max. @ 20 V AC or DC max.
 MECHANICAL & ELECTRICAL LIFE: 40,000 make-and-break cycles at full load.
 CONTACT RESISTANCE: Below 50 m Ω typ. initial @ 2-4 V DC, 100 mA.
 INSULATION RESISTANCE: 10⁹ Ω min.
 DIELECTRIC STRENGTH: 500 Vrms min. @ sea level.
 OPERATING TEMPERATURE: -30°C to 85°C.
 SOLDERABILITY: Per MIL-STD-202F method 208D, or EIA RS-186E method 9 (1 hour steam aging).
 PACKAGING: Surface mount switches shipped in anti-static tape and reel packaging per EIA 481-3, see page F-47 for drawings and reel information. Tape and cover strip are conductive for use near statically sensitive components, consult Customer Service Center.

Materials

HOUSING AND BASE: Glass filled nylon 4/6, flame retardant, heat stabilized (UL 94V-0).
 ACTUATOR: Glass filled nylon 4/6, flame retardant, heat stabilized (UL 94V-0), with standard internal o-ring seal.
 SWITCH SUPPORT: Brass, tin plated.
 MOVABLE CONTACTS: Copper alloy, with gold plate over nickel plate.
 STATIONARY CONTACTS: Copper alloy, with gold plate over nickel plate.
 TERMINALS: Gold.
 TERMINAL SEAL: Epoxy. All terminals insert molded.

NOTE: Specifications and materials listed above are for switches with standard options. For information on specific and custom switches, consult Customer Service Center.

How To Order

Complete part numbers for GT Series Sealed Ultraminiature Toggle Switches are shown on pages F-43 thru F-47.



GT11MCBE
SPDT

PART NUMBER	SWITCH FUNCTION		
	POS. 1	POS. 2	POS. 3
GT11MCBE	ON	NONE	ON
GT13MCBE	ON	OFF	ON
Conn. Terms.	2-3	OPEN	2-1
Schematic			
SPDT	Note: Pins 4 and 6 not connected		
GT12MCBE	OFF	NONE	ON
Conn. Terms.	OPEN	N/A	3-1
Schematic			
SPST	Note: Pins 4 and 6 not connected		

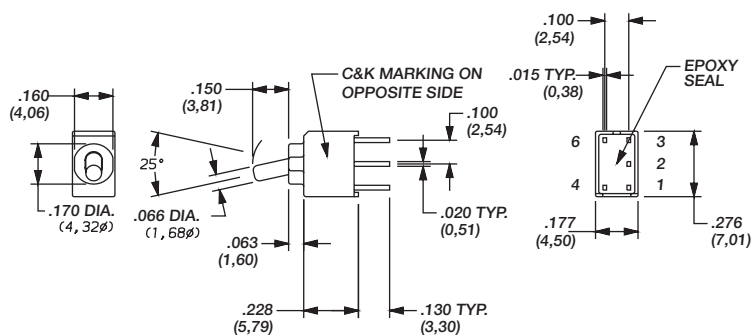

ACTUATOR SHOWN IN POS. 1

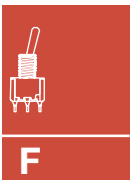
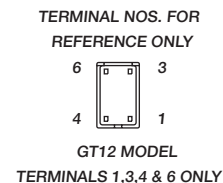
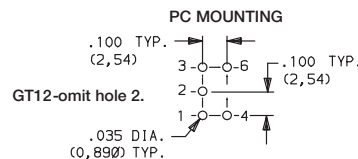

Toggle



Dimensions are shown: Inches (mm)
 Specifications and dimensions subject to change

GT Series Sealed Ultraminiature Toggle Switches

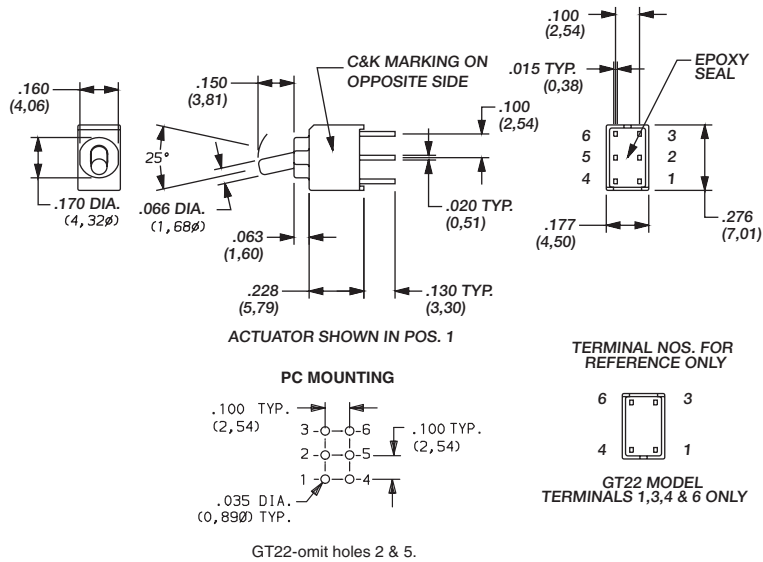

PART NUMBER	SWITCH FUNCTION		
	POS. 1	POS. 2	POS. 3
GT21MCBE GT23MCBE	ON	NONE	ON
Conn. Terms.	2-3, 5-6	OPEN	2-1, 5-4
Schematic			
DPDT			
GT22MCBE	OFF	NONE	ON
Conn. Terms.	OPEN	N/A	3-1
Schematic			
DPST			

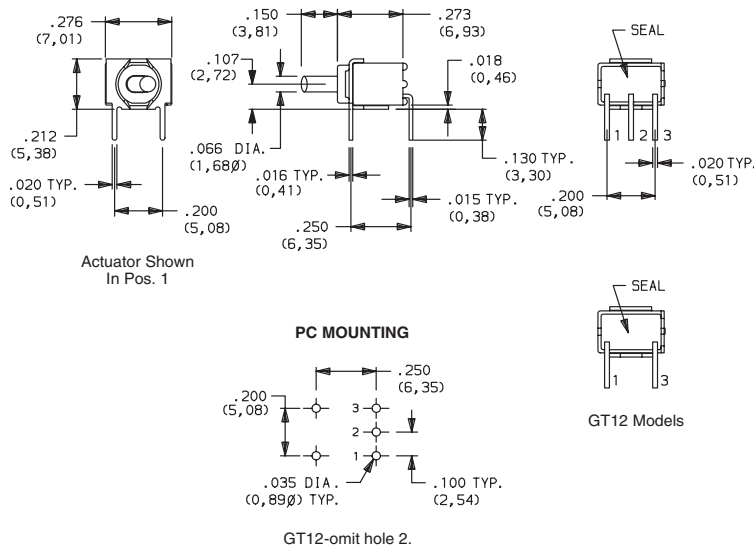

PART NUMBER	SWITCH FUNCTION		
	POS. 1	POS. 2	POS. 3
GT11MABE GT13MABE	ON	NONE	ON
Conn. Terms.	2-3	OPEN	2-1
Schematic			
SPDT			
GT12MABE	OFF	NONE	ON
Conn. Terms.	OPEN	N/A	3-1
Schematic			
SPST			

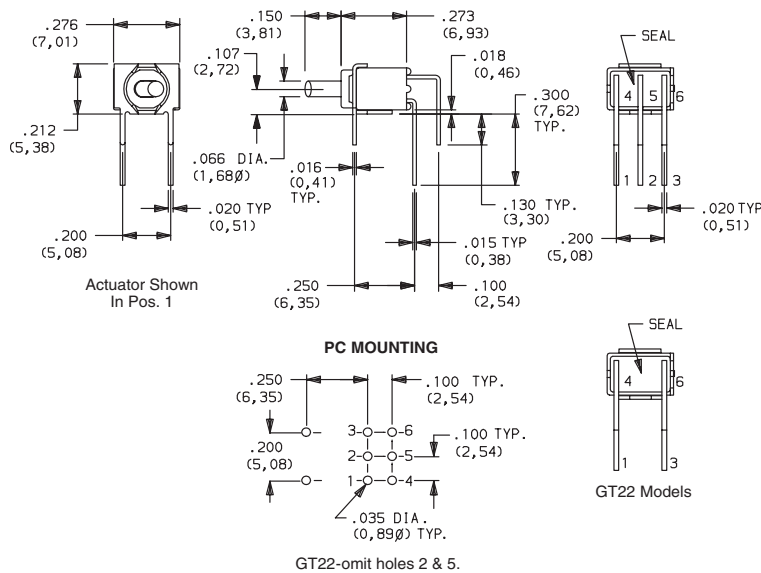

PART NUMBER	SWITCH FUNCTION		
	POS. 1	POS. 2	POS. 3
GT21MABE GT23MABE	ON	NONE	ON
Conn. Terms.	2-3, 5-6	OPEN	2-1, 5-4
Schematic			
DPDT			
GT22MABE	OFF	NONE	ON
Conn. Terms.	OPEN	N/A	3-1, 6-4
Schematic			
DPST			



Dimensions are shown: Inches (mm)
Specifications and dimensions subject to change

GT Series Sealed Ultraminiature Toggle Switches



GT11MAVBE
Vertical
Actuation
SPDT

PART NUMBER	SWITCH FUNCTION		
	POS.1	POS. 2	POS. 3
GT11MAVBE	ON	NONE	ON
GT13MAVBE	ON	OFF	ON
Conn. Terms.	2-3	OPEN	2-1
Schematic			
SPDT			
GT12MAVBE	OFF	NONE	ON
Conn. Terms.	OPEN	N/A	3-1
Schematic			
SPST			

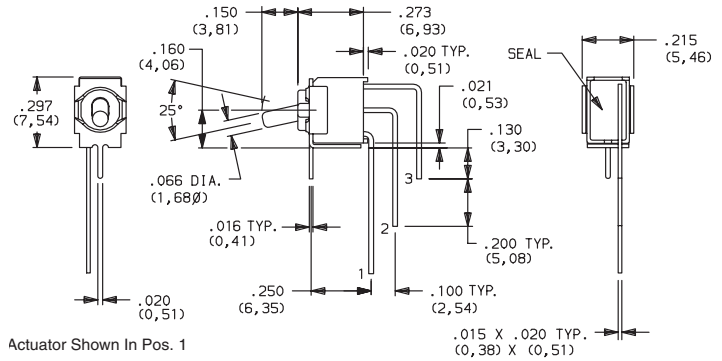

Actuator Shown In Pos. 1

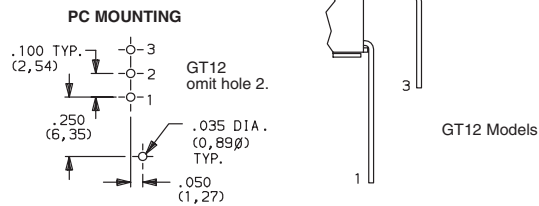

PC MOUNTING

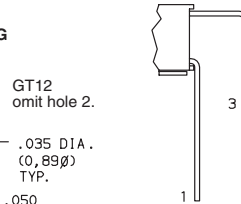

GT12 Models



GT21MAVBE
Vertical
Actuation
DPDT

PART NUMBER	SWITCH FUNCTION		
	POS.1	POS. 2	POS. 3
GT21MAVBE	ON	NONE	ON
GT23MAVBE	ON	OFF	ON
Conn. Terms.	2-3, 5-6	OPEN	2-1, 5-4
Schematic			
DPDT			
GT22MAVBE	OFF	NONE	ON
Conn. Terms.	OPEN	N/A	3-1, 6-4
Schematic			
DPST			

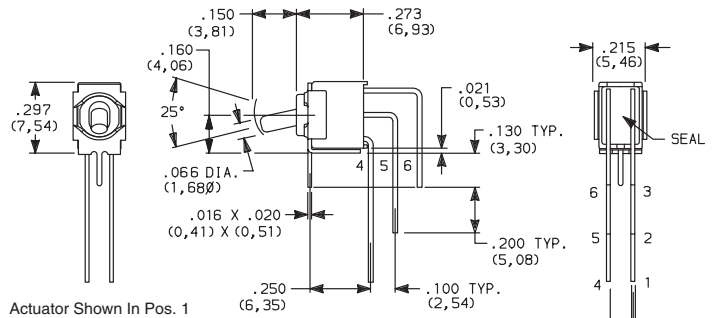

Actuator Shown In Pos. 1

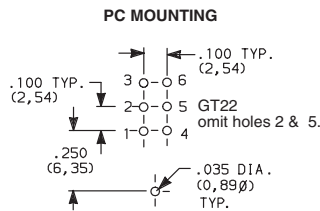

PC MOUNTING

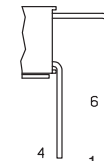

GT22 Models:
1, 3, 4 & 6 terminals only.



GT11MV3BE
SPDT

PART NUMBER	SWITCH FUNCTION		
	POS.1	POS. 2	POS. 3
GT11MV3BE	ON	NONE	ON
GT13MV3BE	ON	OFF	ON
Conn. Terms.	2-3	OPEN	2-1
Schematic			
SPDT	Note: Pins 4 and 6 not connected		
GT12MV3BE	OFF	NONE	ON
Conn. Terms.	OPEN	N/A	3-1
Schematic			
SPST	Note: Pins 4 and 6 not connected		

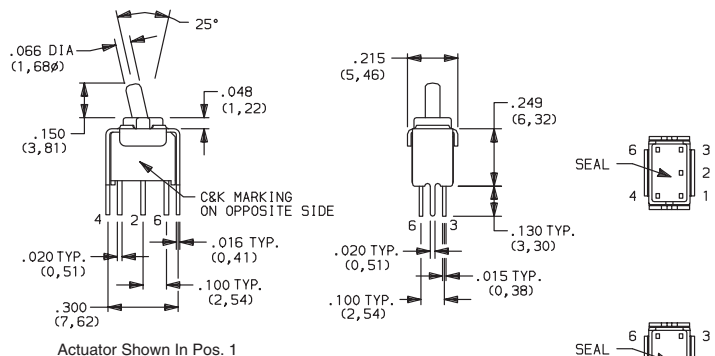

Actuator Shown In Pos. 1

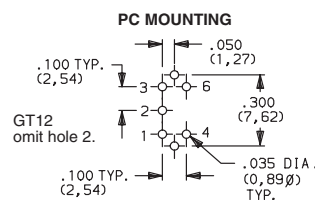

PC MOUNTING

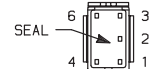
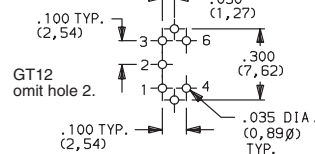

GT12 Models

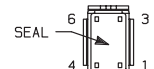

GT12 Models

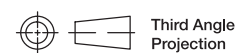

Third Angle
Projection

Dimensions are shown: Inches (mm)
Specifications and dimensions subject to change



GT Series Sealed Ultraminiature Toggle Switches



**GT21MV3BE
DPDT**

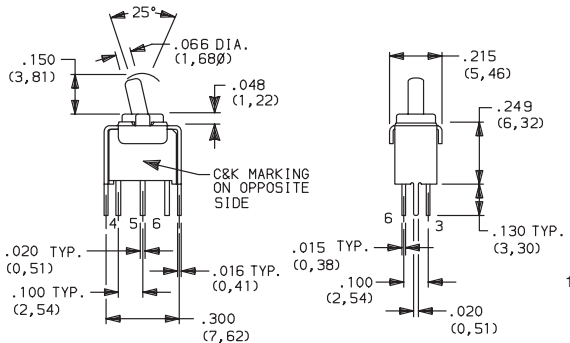

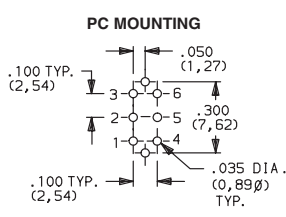

Actuator Shown In Pos. 1

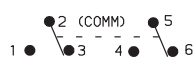

PC MOUNTING

GT22 Models:
1, 3, 4 & 6 terminals only.

PART NUMBER	SWITCH FUNCTION		
	POS. 1	POS. 2	POS. 3
GT21MV3BE GT23MV3BE	ON	NONE	ON
Conn. Terms.	2-3, 5-6	OPEN	2-1, 5-4
Schematic			
GT22MV3BE	OFF	NONE	ON
Conn. Terms.	OPEN	N/A	3-1, 6-4
Schematic			
DPST			



**GT11MSABE
Horizontal
Actuation
SPDT**

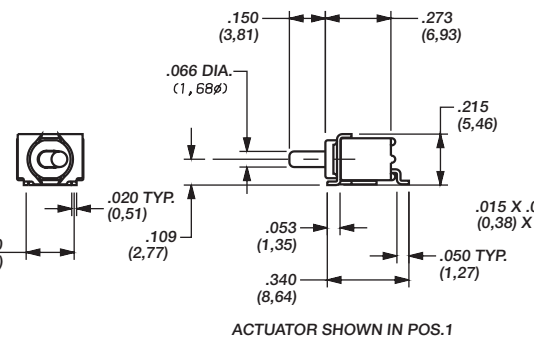

ACTUATOR SHOWN IN POS. 1

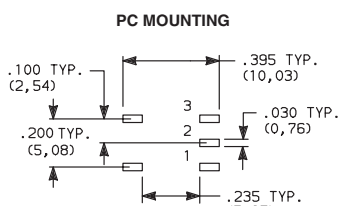



PC MOUNTING

TERM NOS. FOR REFERENCE ONLY

EPOXY SEAL

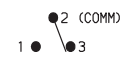
**GT12 MODEL
TERMS. 1 & 3 ONLY**

PART NUMBER	SWITCH FUNCTION		
	POS. 1	POS. 2	POS. 3
GT11MSABETR GT13MSABETR	ON	NONE	ON
Conn. Terms.	2-3	OPEN	2-1
Schematic			
GT12MSABETR	OFF	NONE	ON
Conn. Terms.	OPEN	N/A	3-1
Schematic			
SPST			

Standard with tape & reel packaging, see page F-47. GT12-omit pad 2.



**GT11MSCBE
SPDT**

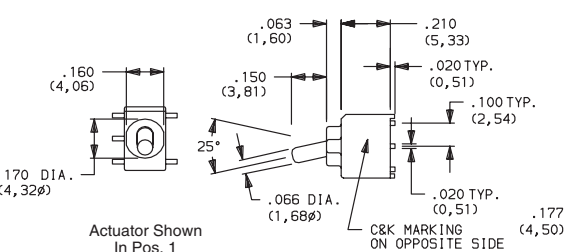

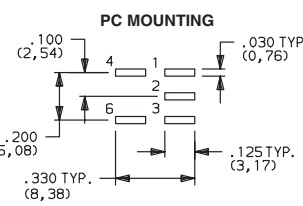

Actuator Shown In Pos. 1



PC MOUNTING

GT12 Models

PART NUMBER	SWITCH FUNCTION		
	POS. 1	POS. 2	POS. 3
GT11MSCBETR GT13MSCBETR	ON	NONE	ON
Conn. Terms.	2-3	OPEN	2-1
Schematic			
GT12MSCBETR	OFF	NONE	ON
Conn. Terms.	OPEN	N/A	3-1
Schematic			
SPST			

Standard with tape & reel packaging, see page F-47.



Toggle



Dimensions are shown: Inches (mm)
Specifications and dimensions subject to change

GT Series Sealed Ultraminiature Toggle Switches



GT21MSCBE
DPDT

PART NUMBER	SWITCH FUNCTION		
	POS. 1	POS. 2	POS. 3
GT21MSCBETR	ON	NONE	ON
GT23MSCBETR	ON	OFF	ON
Conn. Terms.	2-3, 5-6	OPEN	2-1, 5-4
Schematic			
DPDT			
GT22MSCBETR	OFF	NONE	ON
Conn. Terms.	OPEN	N/A	3-1, 6-4
Schematic			
DPST			

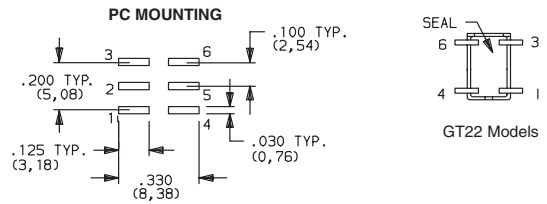
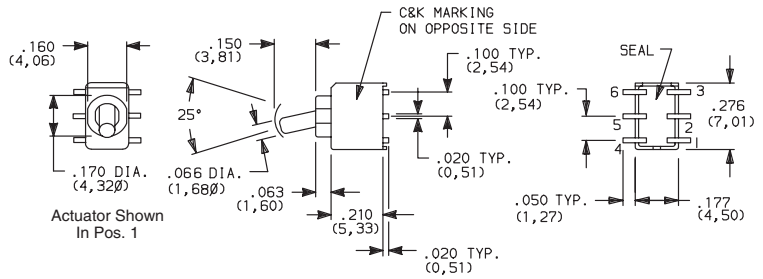

GT22-omit pads 2 & 5.
Standard with tape & reel packaging

TAPE & REEL

For part numbers GT11MSABE, GT12MSABE, GT13MSABE

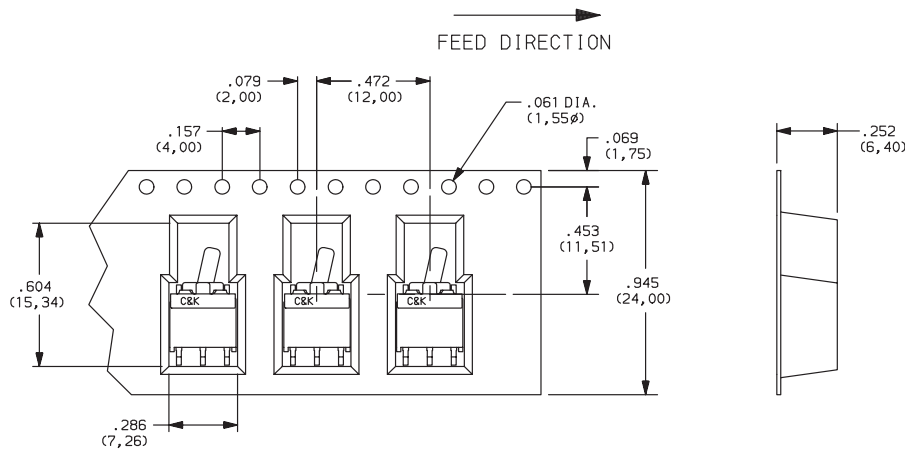

REEL INFORMATION	
OUTSIDE DIAMETER	13.00 (330,0)
PILOT HOLE	.512 (13,0)
QUANTITY PER REEL	600

For part numbers GT11MSCBE, GT12MSCBE, GT13MSCBE, GT21MSCBE, GT22MSCBE, GT23MSCBE,

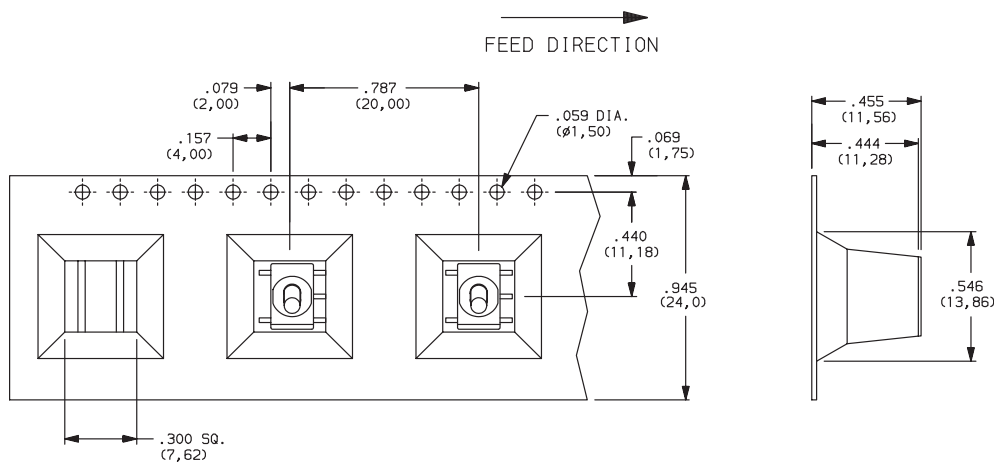

REEL INFORMATION	
OUTSIDE DIAMETER	13.00 (330,0)
PILOT HOLE	.512 (13,0)
QUANTITY PER REEL	200



Third Angle
Projection

Dimensions are shown: Inches (mm)
Specifications and dimensions subject to change

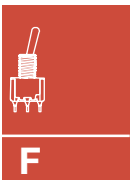

F

Toggle