

# BPA Series Side Actuated DIP Switches



H

DIP



## Features/Benefits

- Side actuated contacts
- Available in thru-hole or SMT models
- High pressure contact system does not require tape seal for washing
- RoHS compliant & compatible

## Typical Applications

- Address switch for industrial controls
- Logic switching for computers and peripherals
- Function controlling for numerous applications

## Specifications

SWITCH FUNCTION: 1 thru 10 and 12 position available.  
 CONTACT RATING: 100 mA max. @ 5 V DC or 25 mA max. @ 24 V DC.  
 MECHANICAL AND ELECTRICAL LIFE: 1,000 cycles min. @ 5 V DC 10mA.  
 CONTACT RESISTANCE: 50 milliohms initial max.  
 INSULATION RESISTANCE: 100 V DC 100 megohms min.  
 DIELECTRIC WITHSTAND VOLTAGE: 300 V AC for 1 minute.  
 STORAGE TEMPERATURE: -40°C to 85°C.  
 OPERATING TEMPERATURE: -20°C to 85°C.  
 OPERATING FORCE: 800 grams max.  
 SOLDERABILITY: Flow solderable and washable (soldering: 260°C for 10 sec. max.)

PACKAGING: Switches supplied in rigid dispensing tubes in full-tube quantities only, this may affect order quantity. Numbers of switches per tube varies with model. Tape and reel packaging available for SMT options.

## Materials

HOUSING: PPS, color black (UL94V-0).  
 COVER: PPS, color black (UL94V-0).  
 ACTUATOR: PA-6T UL94V-0).  
 CONTACTS: Beryllium Copper with Gold over Nickel plate.  
 TERMINALS: Brass, Gold over Nickel plate.

**Note:** Specifications and materials listed above are for switches with standard options. For information on specific and custom switches, consult Customer Service Center.

## How To Order

The Build-A Switch concept allows you to mix and match options to create the switch you need. Below is a complete listing of options shown in catalog. To order, simply select desired option from each category and place in the appropriate box.

All switches supplied in "OFF" position.

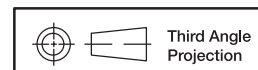
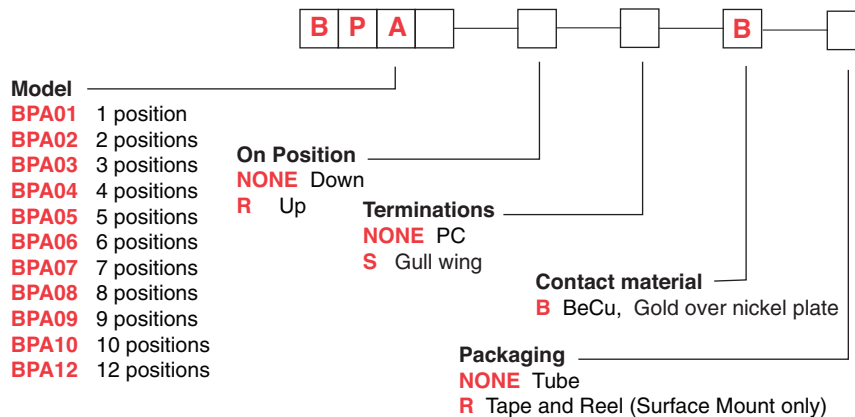

Dimensions are shown: Inch (mm)

Specifications and dimensions subject to change



# BPA Series Side Actuated DIP Switches

## Side Actuator – Thru-hole Terminals

ROHS PART NUMBER	NO. POS.	DIM. 'A'	DIM. 'B'	QUANTITY PER TUBE
<b>BPA01B</b>	1	.176 (4,48)	N/A	100
<b>BPA02B</b>	2	.276 (7,0)	.100 (2,54)	60
<b>BPA03B</b>	3	.376 (9,6)	.200 (5,08)	45
<b>BPA04B</b>	4	.476 (12,1)	.300 (7,62)	35
<b>BPA05B</b>	5	.575 (14,6)	.400 (10,16)	30
<b>BPA06B</b>	6	.677 (17,2)	.500 (12,70)	25
<b>BPA07B</b>	7	.776 (19,7)	.600 (15,24)	20
<b>BPA08B</b>	8	.878 (22,3)	.700 (17,78)	20
<b>BPA09B</b>	9	.976 (24,8)	.800 (20,32)	15
<b>BPA10B</b>	10	1.075 (27,3)	.900 (22,86)	15
<b>BPA12B</b>	12	1.280 (32,5)	1.100 (27,94)	14

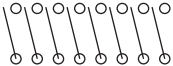
Schematic 

SPST

**NOTE:** Reverse throw available, contact C&K for P/N and quote.



BPA08B

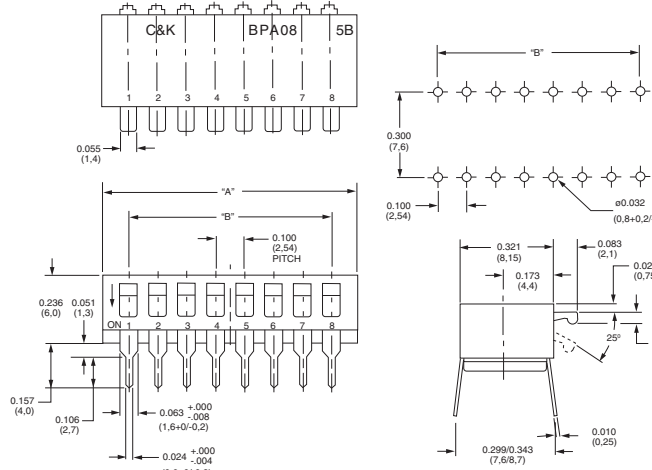

## Side Actuator – Surface Mount Terminals

ROHS PART NUMBER	NO. POS.	DIM. 'A'	DIM. 'B'	QUANTITY PER TUBE
<b>BPA01SB</b>	1	.176 (4,48)	N/A	100
<b>BPA02SB</b>	2	.276 (7,0)	.100 (2,54)	60
<b>BPA03SB</b>	3	.376 (9,6)	.200 (5,08)	45
<b>BPA04SB</b>	4	.476 (12,1)	.300 (7,62)	35
<b>BPA05SB</b>	5	.575 (14,6)	.400 (10,16)	30
<b>BPA06SB</b>	6	.677 (17,2)	.500 (12,70)	25
<b>BPA07SB</b>	7	.776 (19,7)	.600 (15,24)	20
<b>BPA08SB</b>	8	.878 (22,3)	.700 (17,78)	20
<b>BPA09SB</b>	9	.976 (24,8)	.800 (20,32)	15
<b>BPA10SB</b>	10	1.075 (27,3)	.900 (22,86)	15
<b>BPA12SB</b>	12	1.280 (32,5)	1.100 (27,94)	14

Schematic 

SPST

**NOTE:** Tape and reel packaging available by adding "R" to end of project number.



BPA08SB

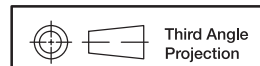
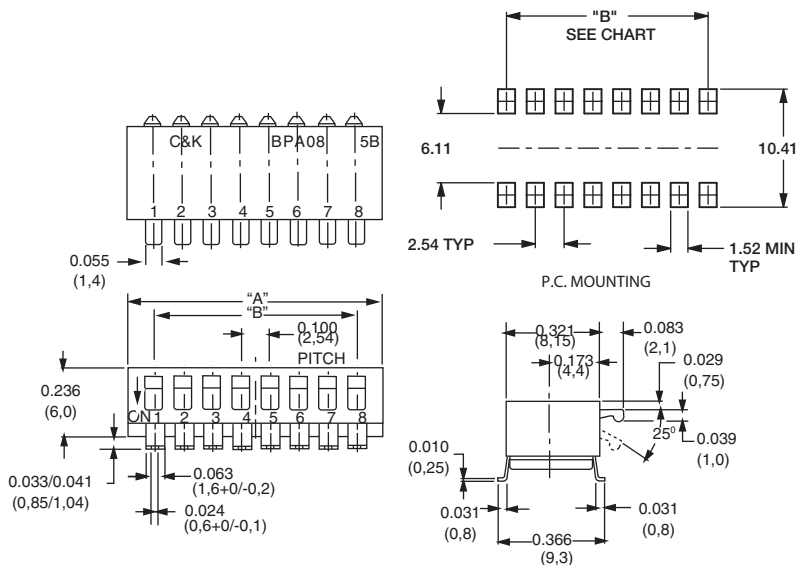

Dimensions are shown: Inch (mm)  
Specifications and dimensions subject to change



# BPA Series Side Actuated DIP Switches

## Tape & Reel Packaging – Surface Mount Options Only

QTY/ REEL	POLES	DIM. 'A'	DIM. 'B'	DIM. 'C'	DIM. 'D'	DIM. 'E'
500	1	.453 (11,5)	—	.945 (24,0)	.530 (13,45)	.960 (24,4)
500	2	.453 (11,5)	—	.945 (24,0)	.311 (7,9)	.960 (24,4)
500	3	.453 (11,5)	—	.945 (24,0)	.409 (10,4)	.960 (24,4)
500	4	.453 (11,5)	—	.945 (24,0)	.508 (12,9)	.960 (24,4)
500	5	.453 (11,5)	—	.945 (24,0)	.606 (15,4)	.960 (24,4)
500	6	.559 (14,2)	1.118 (28,4)	1.260 (32,0)	.709 (18,0)	1.275 (32,4)
500	7	.559 (14,2)	1.118 (28,4)	1.260 (32,0)	.807 (20,5)	1.275 (32,4)
500	8	.795 (20,2)	1.590 (40,4)	1.732 (44,0)	.894 (22,7)	1.748 (44,4)
500	9	.795 (20,2)	1.590 (40,4)	1.732 (44,0)	1.004 (25,5)	1.748 (44,4)
500	10	.795 (20,2)	1.590 (40,4)	1.732 (44,0)	1.106 (28,1)	1.748 (44,4)
500	12	.795 (20,2)	1.590 (40,4)	1.732 (44,0)	1.311 (33,3)	1.748 (44,4)

Note: For tape and reel packaging, add 'R' to end of part number.

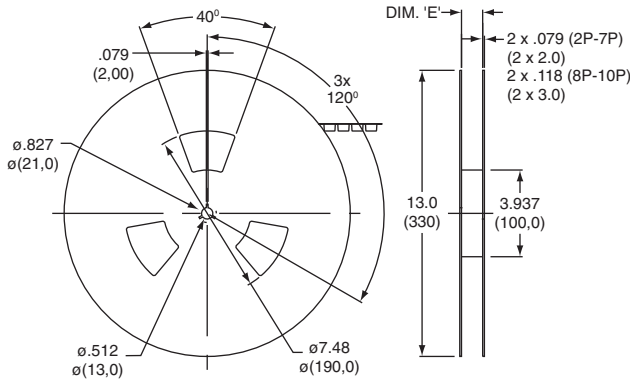

## Tube Packaging

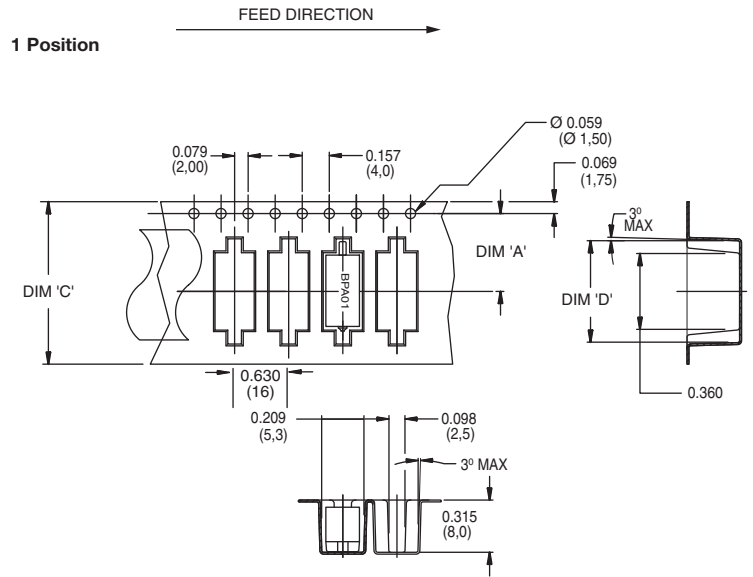
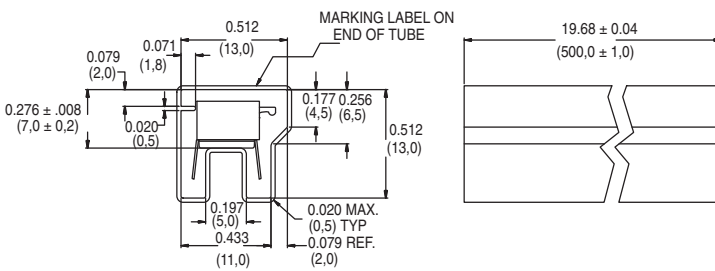

## 2, 3, 4 & 5 Positions

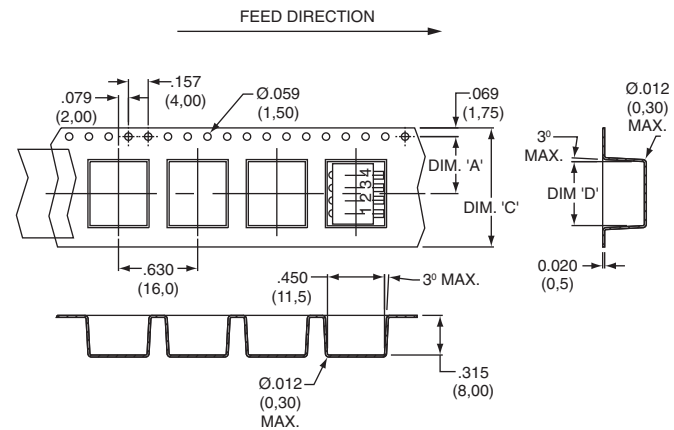

## 6, 7, 8, 9, 10 & 12 Positions

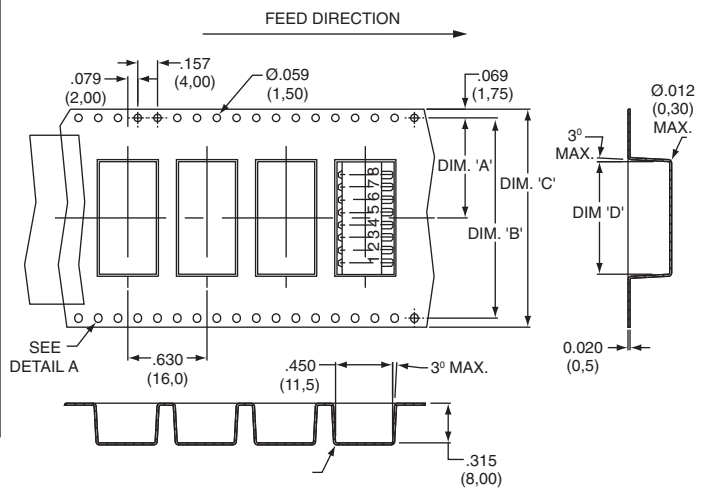

Dimensions are shown: Inch (mm)  
Specifications and dimensions subject to change