

12 CIRCUIT RECEPTACLE WITH LOCK BRIDGE
POLARIZATION OPTION A
USCAR COMPATIBLE

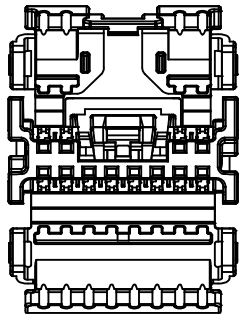

12 CIRCUIT RECEPTACLE WITH LOCK BRIDGE
POLARIZATION OPTION B
USCAR COMPATIBLE

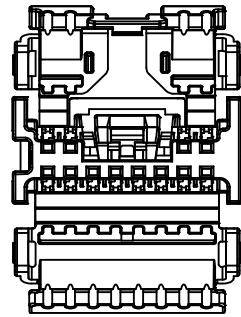

12 CIRCUIT RECEPTACLE WITH LOCK BRIDGE
POLARIZATION OPTION C
USCAR COMPATIBLE

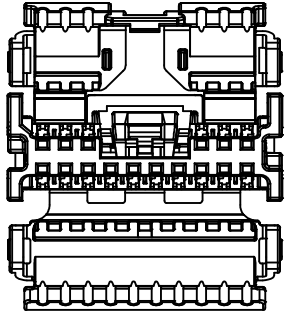

16 CIRCUIT RECEPTACLE WITH LOCK BRIDGE
POLARIZATION OPTION A

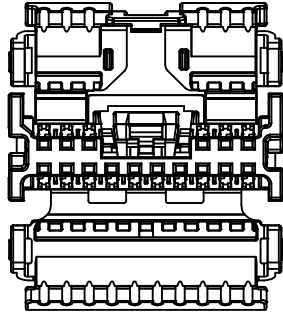

16 CIRCUIT RECEPTACLE WITH LOCK BRIDGE
POLARIZATION OPTION B

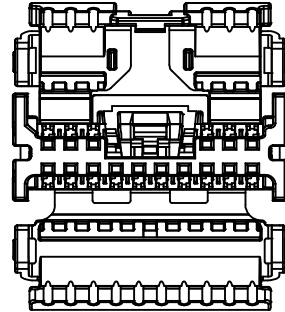

16 CIRCUIT RECEPTACLE WITH LOCK BRIDGE
POLARIZATION OPTION C

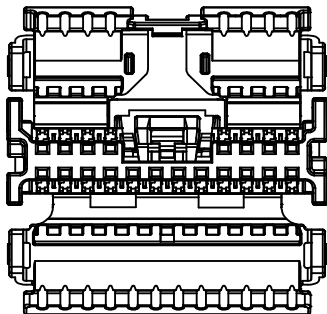

20 CIRCUIT RECEPTACLE WITH LOCK BRIDGE
POLARIZATION OPTION A

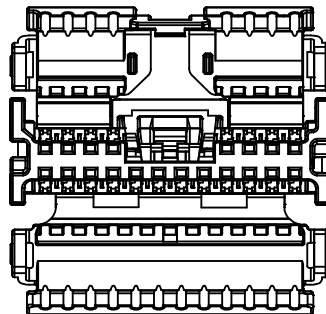

20 CIRCUIT RECEPTACLE WITH LOCK BRIDGE
POLARIZATION OPTION B

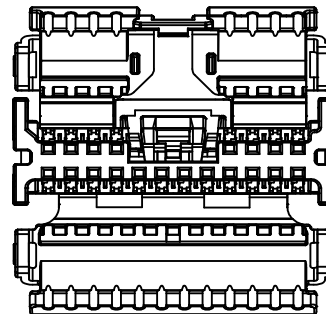

20 CIRCUIT RECEPTACLE WITH LOCK BRIDGE
POLARIZATION OPTION C

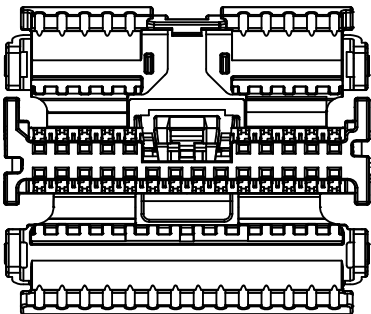

24 CIRCUIT RECEPTACLE WITH LOCK BRIDGE
POLARIZATION OPTION A

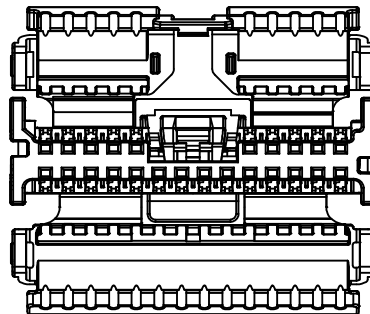

24 CIRCUIT RECEPTACLE WITH LOCK BRIDGE
POLARIZATION OPTION B

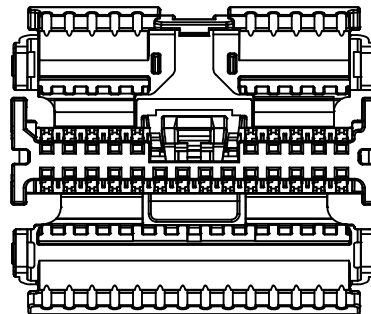

24 CIRCUIT RECEPTACLE WITH LOCK BRIDGE
POLARIZATION OPTION C

MODEL CORRECTED EC NO: UAU2016-0125 DRAWNSREWITT 2015/07/27 APPROVAL APPR: BRAUMAN 2015/07/28 REV DESCRIPTION	QUALITY SYMBOLS	GENERAL TOLERANCES (UNLESS SPECIFIED)	DIMENSION STYLE MM ONLY	SCALE 6:1	DESIGN UNITS METRIC	THIRD ANGLE PROJECTION 																														
	$\nabla \ominus$ $\nabla \ominus$ $\nabla \ominus$	<table border="1"> <thead> <tr> <th></th> <th>mm</th> <th>INCH</th> </tr> </thead> <tbody> <tr> <td>4 PLACES</td> <td>+ .005</td> <td>+ .0005</td> </tr> <tr> <td>3 PLACES</td> <td>+ .008</td> <td>+ .0008</td> </tr> <tr> <td>2 PLACES</td> <td>+ 0.10</td> <td>+ .004</td> </tr> <tr> <td>1 PLACE</td> <td>+ 0.20</td> <td>+ .008</td> </tr> <tr> <td>0 PLACE</td> <td>±</td> <td>±</td> </tr> </tbody> </table>		mm	INCH	4 PLACES	+ .005	+ .0005	3 PLACES	+ .008	+ .0008	2 PLACES	+ 0.10	+ .004	1 PLACE	+ 0.20	+ .008	0 PLACE	±	±	<table border="1"> <thead> <tr> <th>DRAWN BY</th> <th>DATE</th> </tr> </thead> <tbody> <tr> <td>TCUCU</td> <td>2011/03/10</td> </tr> <tr> <th>CHECKED BY</th> <th>DATE</th> </tr> <tr> <td>TMACHUGA</td> <td>2011/03/11</td> </tr> <tr> <th>APPROVED BY</th> <th>DATE</th> </tr> <tr> <td>SMARCEAU</td> <td>2012/05/23</td> </tr> </tbody> </table>	DRAWN BY	DATE	TCUCU	2011/03/10	CHECKED BY	DATE	TMACHUGA	2011/03/11	APPROVED BY	DATE	SMARCEAU	2012/05/23	MATERIAL NO. SEE TABLE	DOCUMENT NO. SD-34824-002	SHEET NO. 2 OF 4
		mm	INCH																																	
	4 PLACES	+ .005	+ .0005																																	
3 PLACES	+ .008	+ .0008																																		
2 PLACES	+ 0.10	+ .004																																		
1 PLACE	+ 0.20	+ .008																																		
0 PLACE	±	±																																		
DRAWN BY	DATE																																			
TCUCU	2011/03/10																																			
CHECKED BY	DATE																																			
TMACHUGA	2011/03/11																																			
APPROVED BY	DATE																																			
SMARCEAU	2012/05/23																																			
DRAFT WHERE APPLICABLE MUST REMAIN WITHIN DIMENSIONS		THIS DRAWING CONTAINS INFORMATION THAT IS PROPRIETARY TO MOLEX, INCORPORATED AND SHOULD NOT BE USED WITHOUT WRITTEN PERMISSION																																		
MoLEX																																				

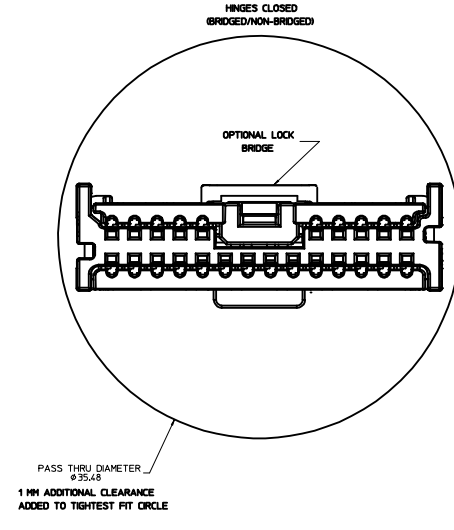
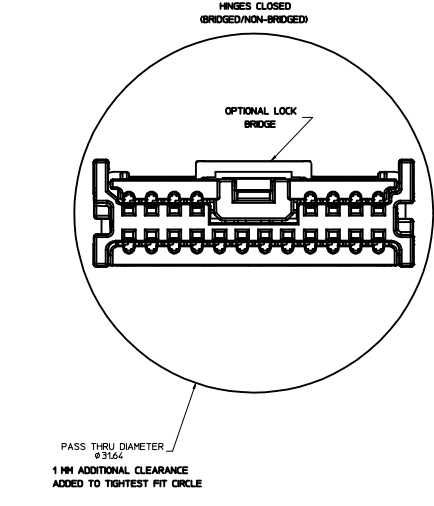
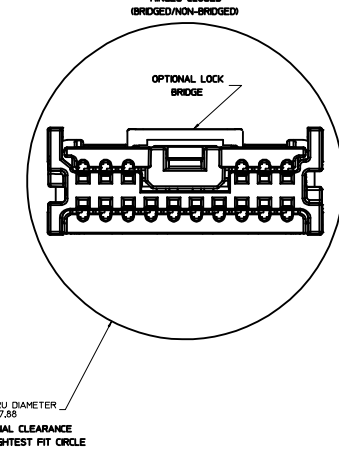
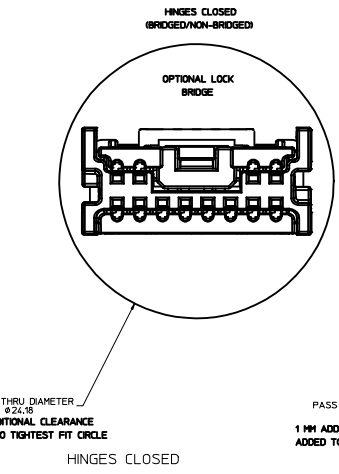
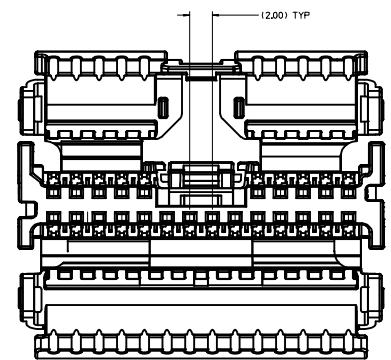
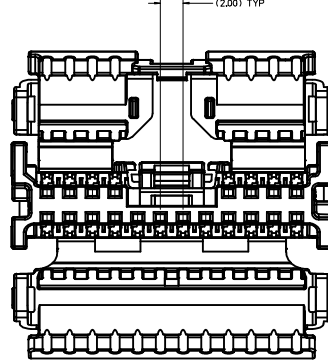
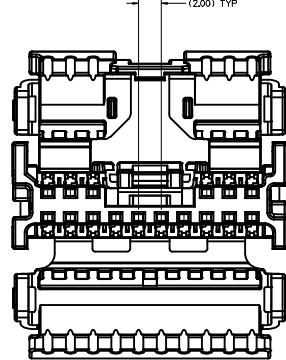
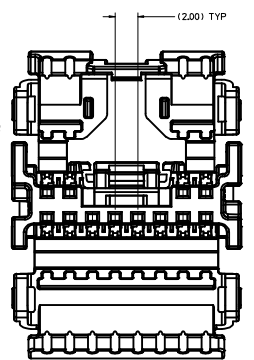
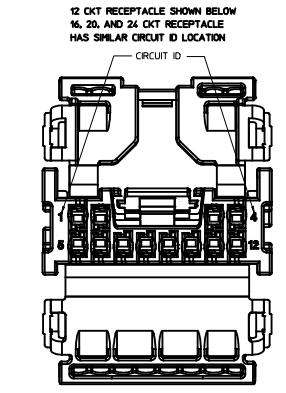
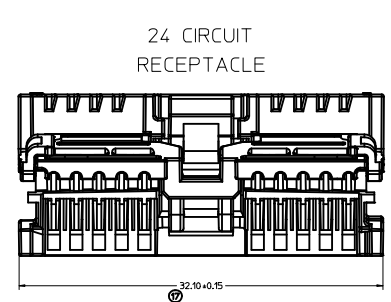
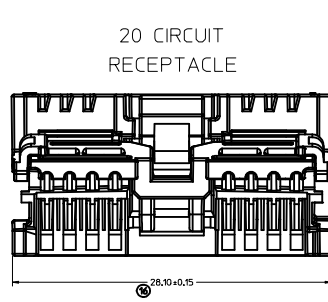
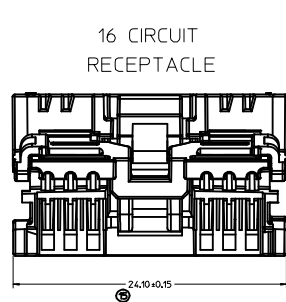
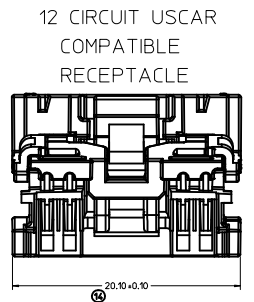
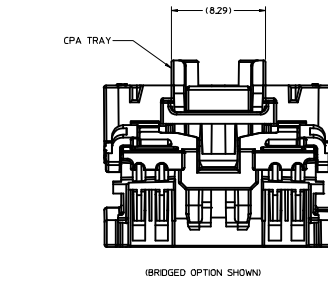
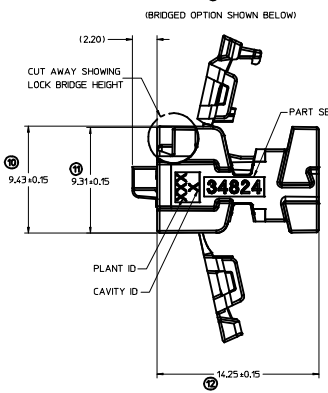
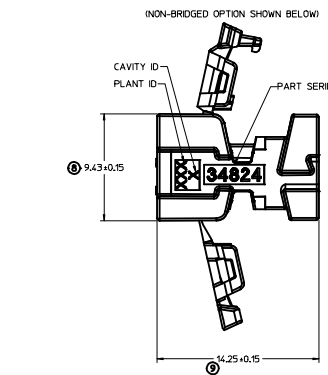

MODEL CORRECTED EC NO: UAU2016-0125 DRAWN BY: 2015/07/27 APPR: BRAUNMAN DATE: 2015/07/28 REV:	QUALITY SYMBOLS 4 PLACES ± --- ± --- 3 PLACES ± --- ± --- 2 PLACES ± 0.10 ± --- 1 PLACE ± 0.20 ± --- 0 PLACE ± ±	GENERAL TOLERANCES (UNLESS SPECIFIED) mm INCH 4 PLACES ± --- ± --- 3 PLACES ± --- ± --- 2 PLACES ± 0.10 ± --- 1 PLACE ± 0.20 ± --- 0 PLACE ± ±	DIMENSION STYLE MM ONLY DRAWN BY: TUCUCU DATE: 2011/03/10 CHECKED BY: TMACHUGA DATE: 2011/03/11 APPROVED BY: SMARCEAU DATE: 2012/05/23	SCALE 6:1 DESIGN UNITS METRIC THIRD ANGLE PROJECTION	TITLE MINISO DUAL ROW RECEPTACLE SALES DRAWING molex	DOCUMENT NO. SD-34824-002 SHEET NO. 3 OF 4	
	ANGULAR ± --- ° DRAFT WHERE APPLICABLE MUST REMAIN WITHIN DIMENSIONS		MATERIAL NO. SEE TABLE	THIS DRAWING CONTAINS INFORMATION THAT IS PROPRIETARY TO MOLEX, INCORPORATED AND SHOULD NOT BE USED WITHOUT WRITTEN PERMISSION			
	THIS DRAWING CONTAINS INFORMATION THAT IS PROPRIETARY TO MOLEX, INCORPORATED AND SHOULD NOT BE USED WITHOUT WRITTEN PERMISSION						
	THIS DRAWING CONTAINS INFORMATION THAT IS PROPRIETARY TO MOLEX, INCORPORATED AND SHOULD NOT BE USED WITHOUT WRITTEN PERMISSION						

MINI50 RECEPTACLE ASSEMBLIES

MATERIAL NUMBER BULK PACKAGING PK-31301-538	LOCK BRIDGE OPTION	CONFIGURATION	CIRCUIT	POL	COLOR	MATING COMPONENT					
						SURFACE MOUNT TECHNOLOGY (SMT) HEADER		VERTICAL	THRU HOLE HEADER	RIGHT ANGLE	THRU HOLE HEADER
						TAPE AND REEL PACKAGING PK-31301-786	TUBE PACKAGING PK-31301-688	TRAY PACKAGING PK-31301-440	TUBE PACKAGING PK-31301-688	TRAY PACKAGING PK-31301-440	TUBE PACKAGING PK-31301-688
34824-0124	NO	USCAR COMPATIBLE	12	A	BLACK	34897-8120	34897-9120	34825-0124	34825-9124	34826-0124	34826-9124
34824-0125	NO	USCAR COMPATIBLE	12	B	GRAY	34897-8121	34897-9121	34825-0125	34825-9125	34826-0125	34826-9125
34824-0126	NO	USCAR COMPATIBLE	12	C	DARK GRAY	34897-8122	34897-9122	34825-0126	34825-9126	34826-0126	34826-9126
34824-1124	YES	USCAR COMPATIBLE	12	A	BLACK	34897-8120	34897-9120	34825-0124	34825-9124	34826-0124	34826-9124
34824-1125	YES	USCAR COMPATIBLE	12	B	GRAY	34897-8121	34897-9121	34825-0125	34825-9125	34826-0125	34826-9125
34824-1126	YES	USCAR COMPATIBLE	12	C	DARK GRAY	34897-8122	34897-9122	34825-0126	34825-9126	34826-0126	34826-9126
34824-0160	NO	MOLEX	16	A	BLACK	34897-8160	34897-9160	34825-0160	34825-9160	34826-0160	34826-9160
34824-0161	NO	MOLEX	16	B	GRAY	34897-8161	34897-9161	34825-0161	34825-9161	34826-0161	34826-9161
34824-0162	NO	MOLEX	16	C	DARK GRAY	34897-8162	34897-9162	34825-0162	34825-9162	34826-0162	34826-9162
34824-1160	YES	MOLEX	16	A	BLACK	34897-8160	34897-9160	34825-0160	34825-9160	34826-0160	34826-9160
34824-1161	YES	MOLEX	16	B	GRAY	34897-8161	34897-9161	34825-0161	34825-9161	34826-0161	34826-9161
34824-1162	YES	MOLEX	16	C	DARK GRAY	34897-8162	34897-9162	34825-0162	34825-9162	34826-0162	34826-9162
34824-0200	NO	MOLEX	20	A	BLACK	34897-8200	34897-9200	34825-0200	34825-9200	34826-0200	34826-9200
34824-0201	NO	MOLEX	20	B	GRAY	34897-8201	34897-9201	34825-0201	34825-9201	34826-0201	34826-9201
34824-0202	NO	MOLEX	20	C	DARK GRAY	34897-8202	34897-9202	34825-0202	34825-9202	34826-0202	34826-9202
34824-1200	YES	MOLEX	20	A	BLACK	34897-8200	34897-9200	34825-0200	34825-9200	34826-0200	34826-9200
34824-1201	YES	MOLEX	20	B	GRAY	34897-8201	34897-9201	34825-0201	34825-9201	34826-0201	34826-9201
34824-1202	YES	MOLEX	20	C	DARK GRAY	34897-8202	34897-9202	34825-0202	34825-9202	34826-0202	34826-9202
34824-0240	NO	MOLEX	24	A	BLACK	34897-8240	34897-9240	34825-0240	34825-9240	34826-0240	34826-9240
34824-0241	NO	MOLEX	24	B	GRAY	34897-8241	34897-9241	34825-0241	34825-9241	34826-0241	34826-9241
34824-0242	NO	MOLEX	24	C	DARK GRAY	34897-8242	34897-9242	34825-0242	34825-9242	34826-0242	34826-9242
34824-1240	YES	MOLEX	24	A	BLACK	34897-8240	34897-9240	34825-0240	34825-9240	34826-0240	34826-9240
34824-1241	YES	MOLEX	24	B	GRAY	34897-8241	34897-9241	34825-0241	34825-9241	34826-0241	34826-9241
34824-1242	YES	MOLEX	24	C	DARK GRAY	34897-8242	34897-9242	34825-0242	34825-9242	34826-0242	34826-9242

CTX50 UNSEALED RECEPTACLE TERMINALS

PART NUMBER		MATERIAL	WIRE GAGE (mm ²)	GRIP
D-WIND (LEFT PAYOFF)	B-WIND (RIGHT PAYOFF)			
560023-0448	560023-0450	COPPER ALLOY	0.35	LARGE
560023-0421	560023-0423	COPPER ALLOY	0.22	MEDIUM
560023-0422	560023-0424	COPPER ALLOY	0.13	SMALL

MODEL CORRECTED EC NO: UAU2016-0125 DRAWN BY: K DATE: 2015/07/27 APPR: BRAUN DATE: 2015/07/28	QUALITY SYMBOLS ▽=0 ▽=0 ▽=0	GENERAL TOLERANCES (UNLESS SPECIFIED) mm INCH 4 PLACES ±.00 ±.000 3 PLACES ±.01 ±.001 2 PLACES ±.02 ±.002 1 PLACE ±.020 ±.003 0 PLACE ± ±	DIMENSION STYLE MM ONLY DRAWN BY: TCUCU DATE: 2011/03/10 CHECKED BY: TMACHUGA DATE: 2011/03/11 APPROVED BY: SMARCEAU DATE: 2012/05/23	SCALE 5:1 DESIGN UNITS METRIC THIRD ANGLE PROJECTION	TITLE MINI50 DUAL ROW RECEPTACLE SALES DRAWING molex	MATERIAL NO. SD-34824-002 DOCUMENT NO.	SHEET NO. 4 OF 4	
	DRAFT WHERE APPLICABLE MUST REMAIN WITHIN DIMENSIONS		SEE TABLE		THIS DRAWING CONTAINS INFORMATION THAT IS PROPRIETARY TO MOLEX INCORPORATED AND SHOULD NOT BE USED WITHOUT WRITTEN PERMISSION			
	ANGULAR ±.000 ±.000		DRAFT WHERE APPLICABLE MUST REMAIN WITHIN DIMENSIONS		SEE TABLE			SHEET NO. 4 OF 4
	ANGULAR ±.000 ±.000		DRAFT WHERE APPLICABLE MUST REMAIN WITHIN DIMENSIONS		SEE TABLE			SHEET NO. 4 OF 4