

NOTES:

- MATERIAL: HOUSING: GLASS FILLED LCP (LIQUID CRYSTAL POLYMER), UL94V-0, BLACK
CONTACTS: COPPER ALLOY
SOLDER CHARGE: 95.5% TIN, 3.8% SILVER, 0.7% COPPER
- FINISH: ALL DIM P HEIGHT OPTIONS - SELECT GOLD IN CONTACT AREA; 30 MICRONCH MINIMUM
DIM P HEIGHT OPTIONS 2.0 & 2.5: SELECT GOLD FLASH ON TAIL, 7 MICRONCH MINIMUM
DIM P HEIGHT OPTIONS 3.0 THRU 7.0: SELECT TIN ON TAIL, 50 MICRONCH MINIMUM
ALL OPTIONS - NICKEL UNDERPLATE OVERALL ON TAIL
- PRODUCT SPECIFICATION: PS-45970-001
- PACKAGING SPECIFICATION: PK-45971-002 (TAPE AND REEL)
- MATES WITH SEARAY RECEPTACLE ASSEMBLY SERIES 45971
- APPLICATION SPECIFICATION: AS-45970-001
- COSMETIC SPECIFICATION: PS-45499-002 CLASS B
- PART STATUS: CONTACT MOLEX

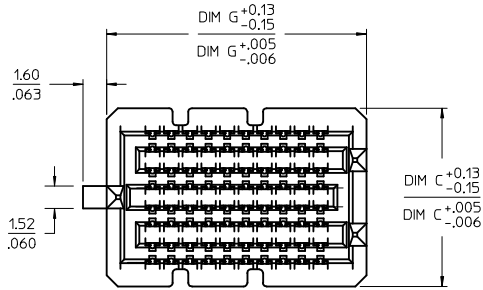

8 ROW
10 POSITION
SHOWN

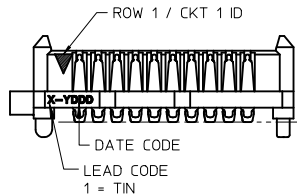

NOTE: THESE CODES MAY BE LOCATED ON EITHER SIDE OF THE HOUSING

SEE TABLE
ACROSS ALL
SOLDER
CHARGES

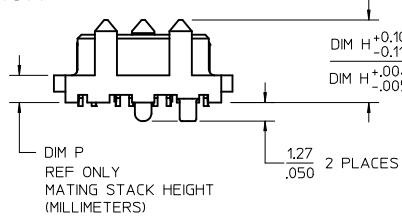

EDGE NOTCHES - SEE TABLE
(THE NUMBER OF NOTCHES
INCREASES AS THE NUMBER
OF POSITIONS INCREASES)

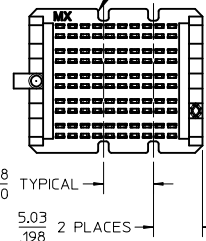

EDGE NOTCHING FOR
10 ROW ASSEMBLIES
(10 POSITION SHOWN)

POSITIONS	TOTAL NUMBER OF EDGE NOTCHES		0.15/.006
	8 ROW	6 AND 10 ROW	
10	4	4	0.15/.006
15	6	6	
20	10	10	
25	12	12	
30	14	14	
35	16	16	0.23/.009
40	18	20	
45	22	22	
50	24	24	

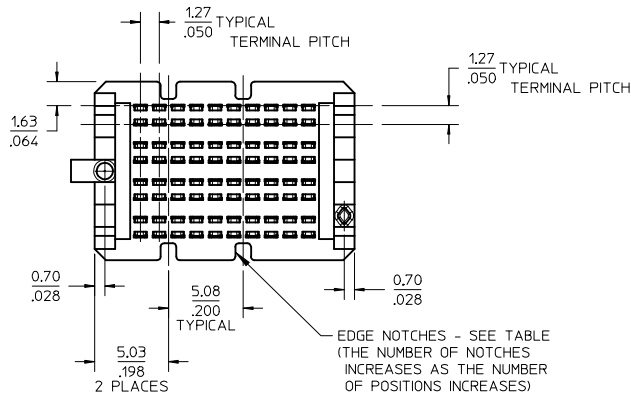

SEE OTHER EDGE NOTCHING VIEWS

SEE SHEET 3
FOR 6 ROW OPTION

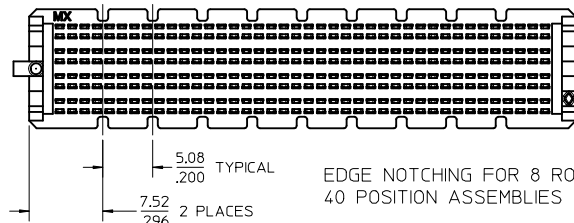

EDGE NOTCHING FOR 8 ROW,
40 POSITION ASSEMBLIES

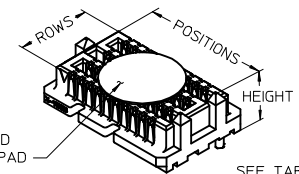

PICK AND
PLACE PAD
SEE SHEET 2
FOR DIAMETERS

SEE TABLE ON SHEET 4
FOR HOUSING OPTIONS

CLARIFY OVERALL LENGTH EC NO: UCP2015-5493 DRWN: SVANG01 2015/06/25 CHKD: TIBARRA 2015/08/04 APPR: SMILLER 2015/08/07	QUALITY SYMBOLS $\nabla F=0$ $\nabla E=0$ $\nabla D=0$	GENERAL TOLERANCES (UNLESS SPECIFIED)		DIMENSION STYLE MM/IN	SCALE 3:1	DESIGN UNITS INCH	THIRD ANGLE PROJECTION
		4 PLACES ± --- ± --- 3 PLACES ± --- ± .010 2 PLACES ± 0.25 ± .015 1 PLACE ± 0.38 ± --- 0 PLACE ± ±	DRAWN BY TREGOR I	DATE 2005/01/27	TITLE SEARAY PLUG ASSEMBLY 1.27/.050 CENTERS molex		
		ANGULAR ± --- ° DRAFT WHERE APPLICABLE MUST REMAIN WITHIN DIMENSIONS	CHECKED BY BBARKER	DATE 2014/08/07	APPROVED BY JCOMERCI		DATE 2010/03/05
		MATERIAL NO. SEE TABLE SHT 4	DOCUMENT NO. SD-45970-001		SHEET NO. 1 OF 4		

THIS DRAWING CONTAINS INFORMATION THAT IS PROPRIETARY TO MOLEX INCORPORATED AND SHOULD NOT BE USED WITHOUT WRITTEN PERMISSION

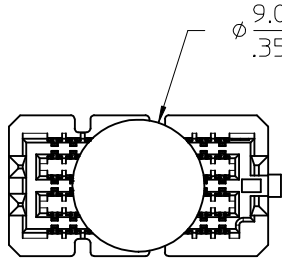

6 ROW OPTION

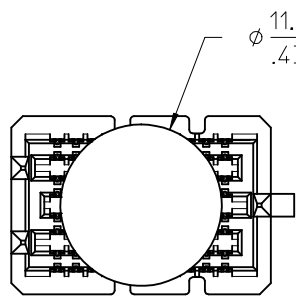

8 ROW OPTION

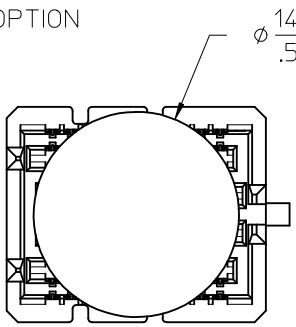

10 ROW OPTION

PICK AND PLACE
PAD DIAMETERS
10 POSITION VERSIONS SHOWN

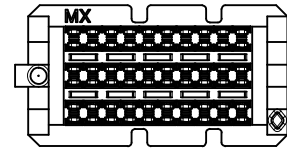
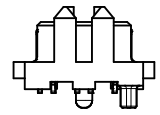
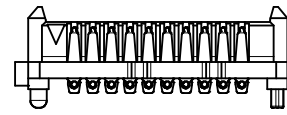
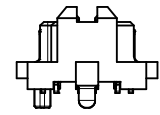
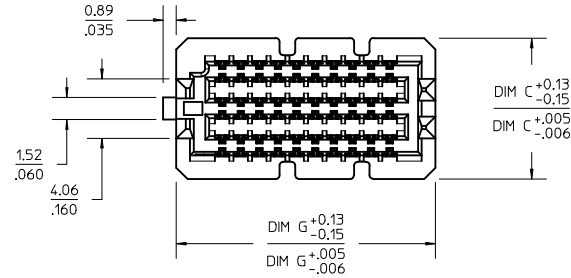

6 ROW OPTION
10 POSITION VERSION
SHOWN FOR REFERENCE

DIMENSIONS SHOWN ON
OTHER SHEETS APPLY TO
THE 6 ROW OPTION ALSO
(EXCEPT AS OTHERWISE
NOTED ON THIS SHEET)

SEE SHEET 1	EC NO: UCP2015-5493 DRWN: SVANG01 2015/06/25 CHKD: TIBARRA 2015/08/04 APPR: SMILLER 2015/08/07	DESCRIPTION	QUALITY SYMBOLS	GENERAL TOLERANCES (UNLESS SPECIFIED)	DIMENSION STYLE	SCALE	DESIGN UNITS	THIRD ANGLE PROJECTION
			▽=0	mm INCH	MM/IN	3:1	INCH	⊙
			▽=0	4 PLACES ± --- ± ---	DRAWN BY DATE	TITLE	SEARAY PLUG ASSEMBLY 1.27/.050 CENTERS	
			▽=0	3 PLACES ± --- ± .010	TGREGORI 2005/01/27			
▽=0	2 PLACES ± 0.25 ± .015	CHECKED BY DATE						
			1 PLACE ± 0.38 ± ---	BBARKER 2014/08/07	APPROVED BY DATE	DOCUMENT NO.	SD-45970-001	SHEET NO. 2 OF 4
			0 PLACE ± ±	JCOMERC I 2010/03/05				
			ANGULAR ± --- °					
			DRAFT WHERE APPLICABLE MUST REMAIN WITHIN DIMENSIONS	MATERIAL NO.	SEE TABLE SHT 4			
				SIZE B	THIS DRAWING CONTAINS INFORMATION THAT IS PROPRIETARY TO MOLEX INCORPORATED AND SHOULD NOT BE USED WITHOUT WRITTEN PERMISSION			

10 9 8 7 6 5 4 3 2 1

6 ROW
10 POSITION
SHOWN

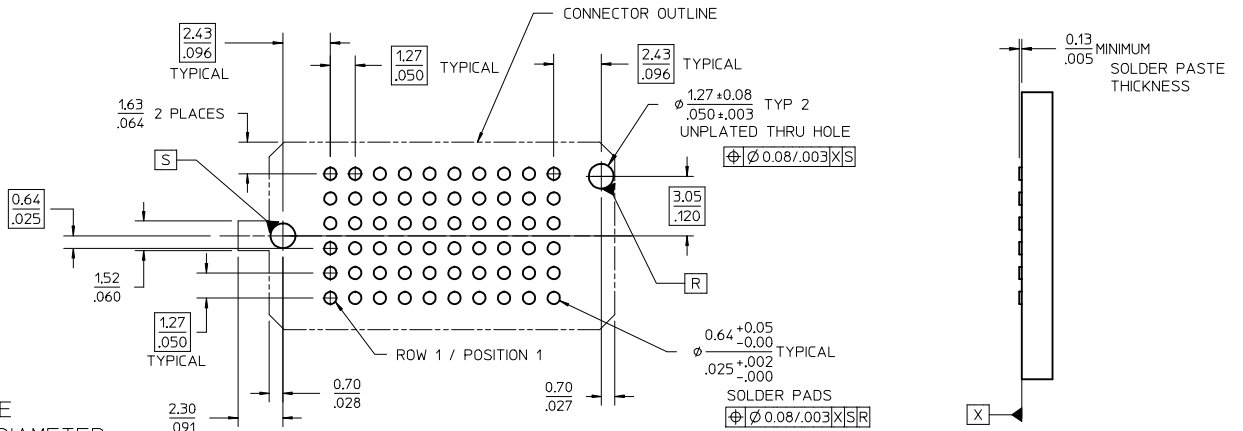

RECOMMENDED PCB LAYOUT: COMPONENT SIDE
SOLDER SCREEN APERTURE SIZE: .890/.035 DIAMETER
PCB THICKNESS: NA

		DIM R RECEPTACLE STACK HEIGHT					
		MM	5.0	6.0	6.5	7.5	8.0
DIM P PLUG STACK HEIGHT	2.0	7.0	8.0	8.5	9.5	10.0	
	3.0	8.0	9.0	9.5	10.5	11.0	
	3.5	8.5	9.5	10.0	11.0	11.5	
	2.5	7.5	8.5	9.0	10.0	10.5	
	4.5	9.5	10.5	11.0	12.0	12.5	
	5.0	10.0	11.0	11.5	12.5	13.0	
	7.0	12.0	13.0	13.5	14.5	15.0	
	9.0	14.0	15.0	15.5	16.5	17.0	

MATED STACK HEIGHTS
GIVEN IN MILLIMETERS (MM) FOR REFERENCE ONLY

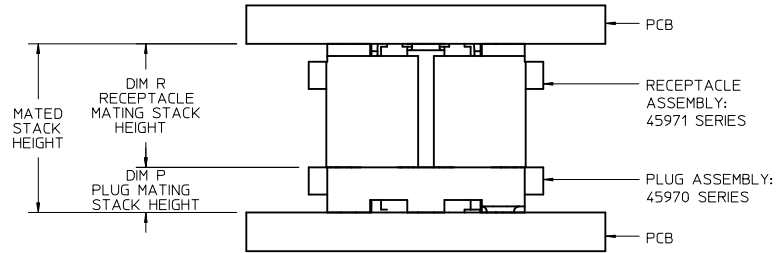

STACK HEIGHTS
GIVEN IN MILLIMETERS (MM) FOR REFERENCE ONLY

SEE SHEET 1 EC NO: UCP2015-5493 DRAWN: SYANG01 2015/06/25 CHKD: TIBARRA 2015/08/04 APPR: SMILLER 2015/08/07	QUALITY SYMBOLS	GENERAL TOLERANCES (UNLESS SPECIFIED)	DIMENSION STYLE	SCALE	DESIGN UNITS	THIRD ANGLE PROJECTION	
	$\nabla F/0$ $\nabla E/0$ $\nabla F/0$	mm	MM/IN	4:1	INCH		
		INCH	MM/IN	DRAWN BY	DATE		TITLE
		4 PLACES ± --- ± --- 3 PLACES ± --- ± .010 2 PLACES ± 0.25 ± .015 1 PLACE ± 0.38 ± --- 0 PLACE ± ±	TGREGORI 2005/01/27 CHECKED BY BBARKER 2014/08/07 APPROVED BY JCOMERC I 2010/03/05	SEARAY PLUG ASSEMBLY 1.27/.050 CENTERS			
ANGULAR ± --- ° DRAFT WHERE APPLICABLE MUST REMAIN WITHIN DIMENSIONS	MATERIAL NO.	DOCUMENT NO.	molex SD-45970-001		SHEET NO. 3 OF 4		
REV	SIZE	THIS DRAWING CONTAINS INFORMATION THAT IS PROPRIETARY TO MOLEX INCORPORATED AND SHOULD NOT BE USED WITHOUT WRITTEN PERMISSION					

9 8 7 6 5 4 3 2 1

ROWS: 6 DIMENSION C = 9.60/.378

DIM P:		2.0 MM	3.0 MM	3.5 MM	2.5 MM	4.5 MM	5.0 MM	7.0 MM
DIM H:		5.61/.221	6.60/.260	7.11/.280	6.12/.241	8.10/.319	8.61/.339	10.61/.418
POSITION	DIM G	MATERIAL NO	MATERIAL NO	MATERIAL NO	MATERIAL NO	MATERIAL NO	MATERIAL NO	MATERIAL NO
10	17.69/0.698	45970-1165	45970-1265	45970-1365	45970-1465	45970-1565	45970-1665	45970-1765
20	30.39/1.198	45970-2165	45970-2265	45970-2365	45970-2465	45970-2565	45970-2665	45970-2765
30	43.09/1.698	45970-3165	45970-3265	45970-3365	45970-3465	45970-3565	45970-3665	45970-3765
40	55.79/2.198	45970-4165	45970-4265	45970-4365	45970-4465	45970-4565	45970-4665	45970-4765
50	68.49/2.698	45970-5165	45970-5265	45970-5365	45970-5465	45970-5565	45970-5665	45970-5765
15	24.04/0.948	45970-6165	45970-6265	45970-6365	45970-6465	45970-6565	45970-6665	45970-6765
25	36.74/1.448	45970-7165	45970-7265	45970-7365	45970-7465	45970-7565	45970-7665	45970-7765
35	49.44/1.948	45970-8165	45970-8265	45970-8365	45970-8465	45970-8565	45970-8665	45970-8765
45	62.14/2.448	45970-9165	45970-9265	45970-9365	45970-9465	45970-9565	45970-9665	45970-9765

ROWS: 8 DIMENSION C = 12.14/.478

DIM P:		2.0 MM	3.0 MM	3.5 MM	2.5 MM	4.5 MM	5.0 MM	7.0 MM
DIM H:		5.61/.221	6.60/.260	7.11/.280	6.12/.241	8.10/.319	8.61/.339	10.61/.418
POSITION	DIM G	MATERIAL NO	MATERIAL NO	MATERIAL NO	MATERIAL NO	MATERIAL NO	MATERIAL NO	MATERIAL NO
10	17.69/0.698	45970-1185	45970-1285	45970-1385	45970-1485	45970-1585	45970-1685	45970-1785
20	30.39/1.198	45970-2185	45970-2285	45970-2385	45970-2485	45970-2585	45970-2685	45970-2785
30	43.09/1.698	45970-3185	45970-3285	45970-3385	45970-3485	45970-3585	45970-3685	45970-3785
40	55.79/2.198	45970-4185	45970-4285	45970-4385	45970-4485	45970-4585	45970-4685	45970-4785
50	68.49/2.698	45970-5185	45970-5285	45970-5385	45970-5485	45970-5585	45970-5685	45970-5785
15	24.04/0.948	45970-6185	45970-6285	45970-6385	45970-6485	45970-6585	45970-6685	45970-6785
25	36.74/1.448	45970-7185	45970-7285	45970-7385	45970-7485	45970-7585	45970-7685	45970-7785
35	49.44/1.948	45970-8185	45970-8285	45970-8385	45970-8485	45970-8585	45970-8685	45970-8785
45	62.14/2.448	45970-9185	45970-9285	45970-9385	45970-9485	45970-9585	45970-9685	45970-9785

ROWS: 10 DIMENSION C = 14.68/.578

DIM P:		2.0 MM	3.0 MM	3.5 MM	2.5 MM	4.5 MM	5.0 MM	7.0 MM	9.0 MM
DIM H:		5.61/.221	6.60/.260	7.11/.280	6.12/.241	8.10/.319	8.61/.339	10.61/.418	12.62/.497
POSITION	DIM G	MATERIAL NO	MATERIAL NO	MATERIAL NO	MATERIAL NO	MATERIAL NO	MATERIAL NO	MATERIAL NO	MATERIAL NO
10	17.69/0.698	45970-1115	45970-1215	45970-1315	45970-1415	45970-1515	45970-1615	45970-1715	45970-1915
20	30.39/1.198	45970-2115	45970-2215	45970-2315	45970-2415	45970-2515	45970-2615	45970-2715	45970-2915
30	43.09/1.698	45970-3115	45970-3215	45970-3315	45970-3415	45970-3515	45970-3615	45970-3715	45970-3915
40	55.79/2.198	45970-4115	45970-4215	45970-4315	45970-4415	45970-4515	45970-4615	45970-4715	45970-4915
50	68.49/2.698	45970-5115	45970-5215	45970-5315	45970-5415	45970-5515	45970-5615	45970-5715	45970-5915
15	24.04/0.948	45970-6115	45970-6215	45970-6315	45970-6415	45970-6515	45970-6615	45970-6715	45970-6915
25	36.74/1.448	45970-7115	45970-7215	45970-7315	45970-7415	45970-7515	45970-7615	45970-7715	45970-7915
35	49.44/1.948	45970-8115	45970-8215	45970-8315	45970-8415	45970-8515	45970-8615	45970-8715	45970-8915
45	62.14/2.448	45970-9115	45970-9215	45970-9315	45970-9415	45970-9515	45970-9615	45970-9715	45970-9915

MATING STACK HEIGHTS (DIMENSION P)
GIVEN IN MILLIMETERS (MM) FOR REFERENCE ONLY

SEE SHEET 1 EC NO: UCP2015-5493 DRWN: SVANG01 2015/06/25 CHKD: TIBARRA 2015/08/04 APPR: SMILLER 2015/08/07	QUALITY SYMBOLS $\nabla F=0$ $\nabla E=0$ $\nabla D=0$	GENERAL TOLERANCES (UNLESS SPECIFIED) <table border="1"> <thead> <tr> <th></th> <th>mm</th> <th>INCH</th> </tr> </thead> <tbody> <tr><td>4 PLACES</td><td>± ---</td><td>± ---</td></tr> <tr><td>3 PLACES</td><td>± ---</td><td>± .010</td></tr> <tr><td>2 PLACES</td><td>± 0.25</td><td>± .015</td></tr> <tr><td>1 PLACE</td><td>± 0.38</td><td>± ---</td></tr> <tr><td>0 PLACE</td><td>±</td><td>±</td></tr> </tbody> </table>		mm	INCH	4 PLACES	± ---	± ---	3 PLACES	± ---	± .010	2 PLACES	± 0.25	± .015	1 PLACE	± 0.38	± ---	0 PLACE	±	±	DIMENSION STYLE MM/IN DRAWN BY: TGREGORI DATE: 2005/01/27 CHECKED BY: BBARKER DATE: 2014/08/07 APPROVED BY: JCOMERCI DATE: 2010/03/05	SCALE: 4:1 DESIGN UNITS: INCH THIRD ANGLE PROJECTION
		mm	INCH																			
	4 PLACES	± ---	± ---																			
	3 PLACES	± ---	± .010																			
2 PLACES	± 0.25	± .015																				
1 PLACE	± 0.38	± ---																				
0 PLACE	±	±																				
DRAFT WHERE APPLICABLE MUST REMAIN WITHIN DIMENSIONS		DIMENSION STYLE: SEE TABLES	TITLE: SEARAY PLUG ASSEMBLY 1.27/.050 CENTERS molex																			
		MATERIAL NO.	DOCUMENT NO. SD-45970-001																			
		SIZE: B	SHEET NO. 4 OF 4																			

THIS DRAWING CONTAINS INFORMATION THAT IS PROPRIETARY TO MOLEX INCORPORATED AND SHOULD NOT BE USED WITHOUT WRITTEN PERMISSION