

FEATURES SELECTION GUIDE

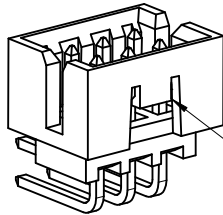

② CENTER LOCK

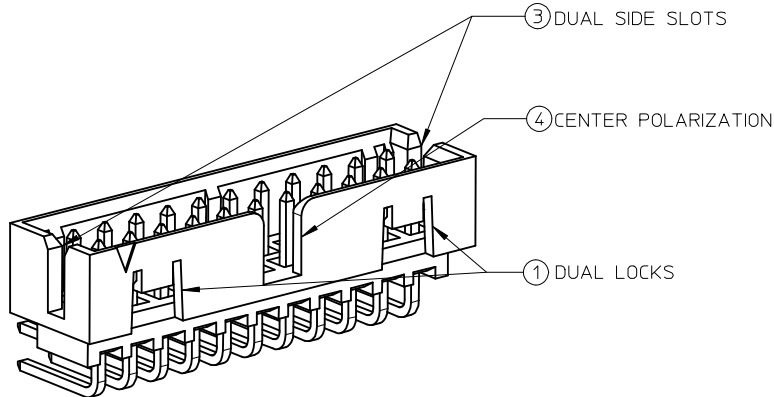

CIRCUIT SIZE	FEATURES				
	FRICTION LOCKS		③ DUAL SIDE SLOTS	④ CENTER POLARIZATION	SHEET NO
	① DUAL	② CENTER			
4 - 6	N.A	N.A	YES	N.A	2 - 3
	N.A	YES	YES	N.A	
8 TO 12	N.A	N.A	YES	YES	4 - 5
	N.A	YES	YES	N.A	
14 TO 50	YES	N.A	YES	YES	6 - 9
	N.A	N.A	YES	YES	

SEE SHEET 2.4.6.7 EC NO: S2016-0454 DRWG:GMENARLY 2015/11/05 CHK'D:CGOH 2015/11/17 APPR:KHL JM 2015/11/18	QUALITY SYMBOLS	GENERAL TOLERANCES (UNLESS SPECIFIED)		DIMENSION STYLE	SCALE	DESIGN UNITS	THIRD ANGLE PROJECTION	
	$F_{\Delta} = 0$	mm	INCH	MM ONLY	NTS	METRIC		
	$F_{\square} = 0$	4 PLACES	± ---	± ---	DRAWN BY	DATE	MILLIGRID 2MM PITCH, SMT R/A SHROUDED HEADER molex	
	$F_{\nabla} = 0$	3 PLACES	± ---	± ---	GMENARLY	2015/09/29		
	$F_{\circ} = 0$	2 PLACES	± 0.20	± ---	CHECKED BY	DATE	SD-87833-0001 SHEET NO. 1 OF 9	
	1 PLACE	± ---	± ---	CGOH	2015/10/30			
	0 PLACE	± ---	± ---	APPROVED BY	DATE	THIS DRAWING CONTAINS INFORMATION THAT IS PROPRIETARY TO MOLEX INCORPORATED AND SHOULD NOT BE USED WITHOUT WRITTEN PERMISSION		
		ANGULAR ± 3 °		MATERIAL NO.	DOCUMENT NO.			
		DRAFT WHERE APPLICABLE MUST REMAIN WITHIN DIMENSIONS		SIZE				
				A3				

4 TO 6 CIRCUITS

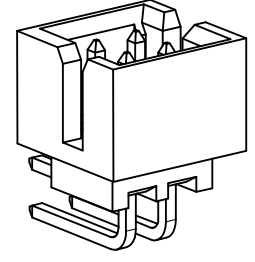
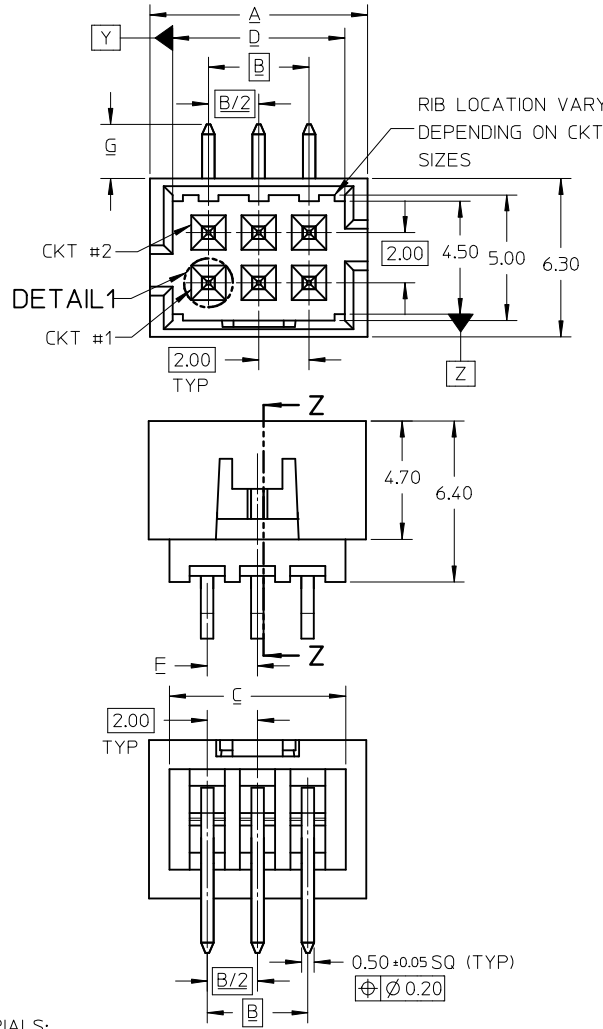

ISO VIEW OF HEADER DUAL SIDE SLOTS

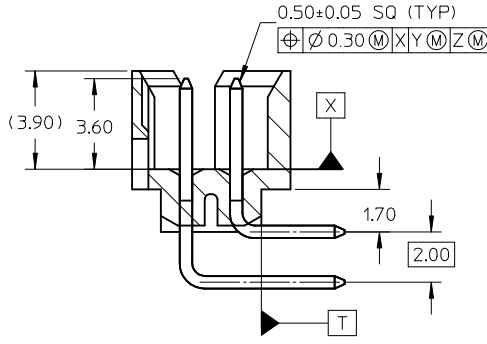

SECTION Z-Z

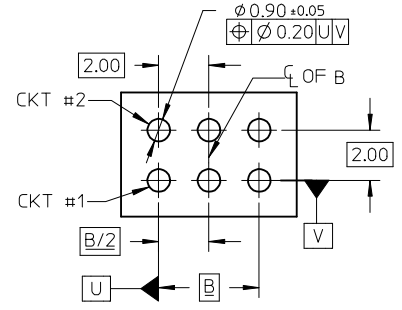
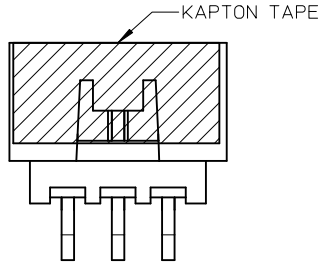

RECOMMENDED PCB LAYOUT

- NOTES:
1. MATERIALS:
HOUSING: 30% GF, NYLON, UL94V-0. COLOR: BLACK
PIN: 0.50MM SQ PHOSPHOR BRONZE
 2. FINISHES: REFER TO PLATING OPTIONS
 3. PRODUCT SPECIFICATION: PS-87831-027
 4. PACKAGING SPECIFICATION:
TUBE: PK-87831-001, TAPE AND REEL: PK-87831-300
 5. MATES WITH: A. MOLEX CRIMP RECEPTACLE HOUSING: 51110 SERIES AND CRIMP TERMINAL: 50394 SERIES
B. MOLEX 2MM MILLIGRID DUAL ROW IDT: 87568 SERIES
C. MOLEX 2MM MILLIGRID DUAL ROW RECEPTACLE: 79107 (GOLD PLATED), 78787 (TIN PLATED)
 6. FOR ILLUSTRATION PURPOSE, 6 CIRCUITS HEADER IS SHOWN

ADD NOTE 6 IEC NO: S2016-0454 DRWNG: GMENARLY 2015/11/05 CHK'D: CGOH 2015/11/17 APPR: KHLIM 2015/11/18	QUALITY SYMBOLS $\nabla_F = 0$ $\nabla_F = 0$ $\nabla_F = 0$	GENERAL TOLERANCES (UNLESS SPECIFIED)		DIMENSION STYLE MM ONLY		SCALE NTS	DESIGN UNITS METRIC	THIRD ANGLE PROJECTION		
			mm	INCH	DRAWN BY GMENARLY	DATE 2015/09/29	TITLE MILLIGRID 2MM PITCH, SMT R/A SHROUDED HEADER			
		4 PLACES	± ---	± ---	CHECKED BY CGOH	DATE 2015/10/30				
		3 PLACES	± ---	± ---	APPROVED BY KHLIM	DATE 2015/11/03				
2 PLACES	± 0.20	± ---	MATERIAL NO.		DOCUMENT NO.		SHEET NO.			
1 PLACE	± ---	± ---	SEE TABLE		SD-87833-0001		2 OF 9			
0 PLACE	± ---	± ---	DRAFT WHERE APPLICABLE MUST REMAIN WITHIN DIMENSIONS		THIS DRAWING CONTAINS INFORMATION THAT IS PROPRIETARY TO MOLEX INCORPORATED AND SHOULD NOT BE USED WITHOUT WRITTEN PERMISSION					
	ANGULAR ± 3°		SIZE A3							

4 TO 6 CIRCUITS

CKT SIZE	ASSY P/N WITHOUT KAPTON IN TUBE	ASSY P/N WITH KAPTON IN TUBE	ASSY P/N WITH KAPTON IN T&R	PLATING OPTIONS	FRICTION LOCKS		DUAL SIDE SLOTS	CENTER POLARIZATION	DIMENSION							
					DUAL	CENTER			A	B	C	D	E	F	G (SOLDER TAIL)	
4	87833-0419	N.A	N.A	1	N.A	N.A	YES	N.A	6.65	2.00	5.00	4.85	N.A	N.A	2.16	
	87833-0420	N.A	N.A	2												
	87833-0421	N.A	N.A	3	N.A	N.A	YES	N.A						N.A	1.00	2.16
	87833-5920	N.A	N.A	2												
	87833-0431	87833-0441	87833-0451	2	N.A	YES	YES	N.A						1.00	3.18	
	87833-0432	N.A	N.A	3												
87833-0461	N.A	N.A	2	N.A	YES	YES	N.A	1.00	3.18							
6	87833-0619	N.A	N.A	1	N.A	N.A	YES	N.A	8.65	4.00	7.00	6.85	N.A	N.A	2.16	
	87833-0620	N.A	N.A	2												
	87833-0621	N.A	N.A	3	N.A	N.A	YES	N.A						N.A	3.18	
	87833-6420	N.A	N.A	2												
	87833-0631	87833-0641	87833-0651	2	N.A	YES	YES	N.A						2.00	2.16	
	87833-0632	N.A	N.A	3												
	87833-0661	N.A	N.A	2	N.A	YES	YES	N.A						2.00	3.18	
	87833-0624	N.A	N.A	2												
87833-0625	N.A	N.A	3	N.A	N.A	YES	N.A	N.A	2.92							

PLATING OPTIONS:

- 1 - 0.05-0.13um/2-5uin GOLD IN CONTACT AREA AND 1.88um/75uin MIN. MATTE TIN IN SOLDER TAIL AREA OVER 1.27um/50uin MIN. NICKEL OVERALL.
- 2 - 0.38um/15uin MIN. GOLD IN CONTACT AREA AND 1.88um/75uin MIN. MATTE TIN IN SOLDER TAIL AREA OVER 1.27um/50uin MIN. NICKEL OVERALL.
- 3 - 0.76um/30uin MIN. GOLD IN CONTACT AREA AND 1.88um/75uin MIN. MATTE TIN IN SOLDER TAIL AREA OVER 1.27um/50uin MIN. NICKEL OVERALL.

SEE SHEET 2,4,6,7 EC NO: S2016-0454 DRWN:GMENARLY 2015/11/05 CHKD:CGOH 2015/11/17 APPR:KHL IM 2015/11/18	DESCRIPTION REV	QUALITY SYMBOLS	GENERAL TOLERANCES (UNLESS SPECIFIED)	DIMENSION STYLE	SCALE	DESIGN UNITS	THIRD ANGLE PROJECTION	
		$\nabla_A = 0$ $\nabla_C = 0$ $\nabla_P = 0$	mm INCH 4 PLACES ± --- ± --- 3 PLACES ± --- ± --- 2 PLACES ± 0.20 ± --- 1 PLACE ± --- ± --- 0 PLACE ± --- ± ---	MM ONLY	NTS	METRIC	DRAWN BY: GMENARLY DATE: 2015/09/29 CHECKED BY: CGOH DATE: 2015/10/30 APPROVED BY: KHL IM DATE: 2015/11/03	TITLE: MILLIGRID 2MM PITCH, SMT R/A SHROUDED HEADER molex
		ANGULAR ± 3 ° DRAFT WHERE APPLICABLE MUST REMAIN WITHIN DIMENSIONS	SEE TABLE	MATERIAL NO. DOCUMENT NO. SD-87833-0001 SHEET NO. 3 OF 9				
		THIS DRAWING CONTAINS INFORMATION THAT IS PROPRIETARY TO MOLEX INCORPORATED AND SHOULD NOT BE USED WITHOUT WRITTEN PERMISSION						

8 TO 12 CIRCUITS

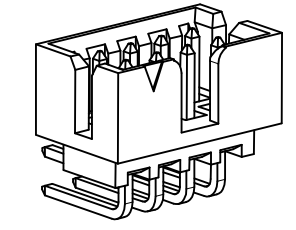
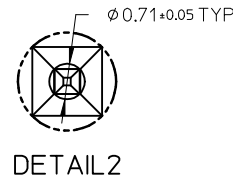
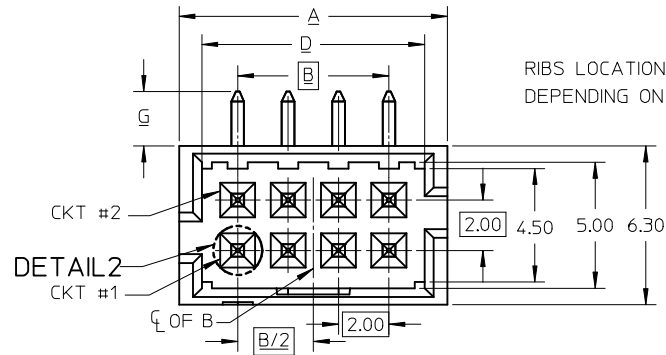

ISO VIEW OF HEADER WITH CENTER POLARIZATION AND DUAL SIDE SLOTS

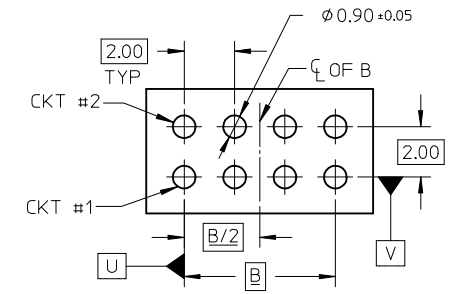
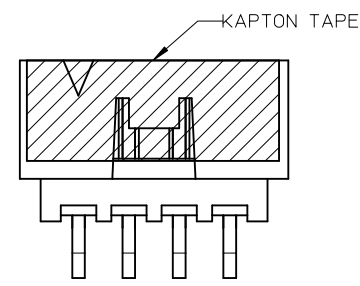
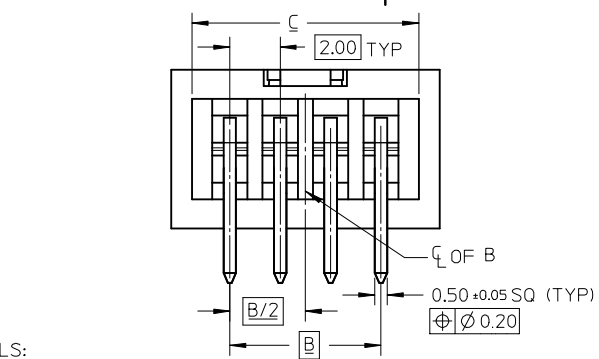
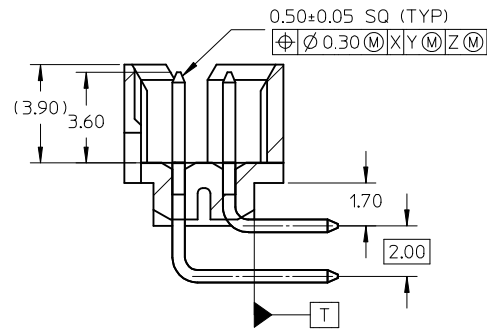
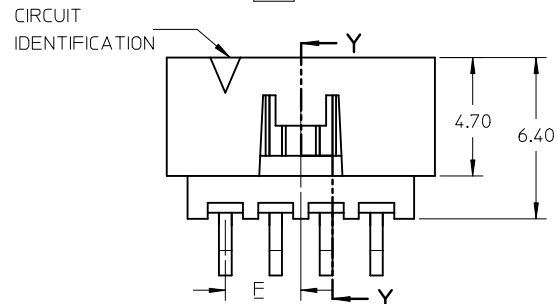

- NOTES:
1. MATERIALS:
HOUSING: 30% GF, NYLON, UL94V-0, COLOR: BLACK
PIN: 0.50MM SQ PHOSPHOR BRONZE
 2. FINISHES: REFER TO PLATING OPTIONS
 3. PRODUCT SPECIFICATION: PS-87831-027
 4. PACKAGING SPECIFICATION:
TUBE: PK-87831-001, TAPE AND REEL: PK-87831-300
 5. MATES WITH: A. MOLEX CRIMP RECEPTACLE HOUSING: 51110 SERIES AND CRIMP TERMINAL: 50394 SERIES
B. MOLEX 2MM MILLIGRID DUAL ROW IDT: 87568 SERIES
C. MOLEX 2MM MILLIGRID DUAL ROW RECEPTACLE: 79107 (GOLD PLATED), 78787 (TIN PLATED)
 6. FOR ILLUSTRATION PURPOSE, 8 CIRCUIT HEADER IS SHOWN

ADD NOTE 6 EC NO: S2016-0454 DRWN:GMENARLY 2015/11/05 CHKD:CGOH 2015/11/17 APPR:KHLIM 2015/11/18	QUALITY SYMBOLS $\nabla_A = 0$ $\nabla_E = 0$ $\nabla_F = 0$	GENERAL TOLERANCES (UNLESS SPECIFIED)		DIMENSION STYLE MM ONLY		SCALE NTS	DESIGN UNITS METRIC	THIRD ANGLE PROJECTION		
		mm	INCH	DRAWN BY	DATE	TITLE				
		4 PLACES ± --- ± ---		GMENARLY	2015/09/29	MILLIGRID 2MM PITCH, SMT R/A SHROUDED HEADER molex				
		3 PLACES ± --- ± ---		CHECKED BY	DATE					
2 PLACES ± 0.20 ± ---		CGOH	2015/10/30	DOCUMENT NO. SD-87833-0001 SHEET NO. 4 OF 9						
1 PLACE ± --- ± ---		APPROVED BY	DATE							
0 PLACE ± --- ± ---		KHLIM	2015/11/03	SEE TABLE THIS DRAWING CONTAINS INFORMATION THAT IS PROPRIETARY TO MOLEX INCORPORATED AND SHOULD NOT BE USED WITHOUT WRITTEN PERMISSION						
ANGULAR ± 3 °		MATERIAL NO.							SIZE A3	
DRAFT WHERE APPLICABLE MUST REMAIN WITHIN DIMENSIONS										

8 TO 12 CIRCUITS

CKT SIZE	ASSY P/N WITHOUT KAPTON IN TUBE	ASSY P/N WITH KAPTON IN TUBE	ASSY P/N WITH KAPTON IN T&R	PLATING OPTIONS	FRICTION LOCKS		DUAL SIDE SLOTS	CENTER POLARIZATION	DIMENSION							
					DUAL	CENTER			A	B	C	D	E	F	G (SOLDER TAIL)	
8	87833-0819	N.A	N.A	1	N.A	N.A	YES	YES	10.65	6.00	9.00	8.85	N.A	N.A	2.16	
	87833-0820	N.A	N.A	2												
	87833-0821	N.A	N.A	3	N.A	N.A	YES	YES						N.A	3.00	2.16
	87833-6320	N.A	N.A	2												
	87833-6321	N.A	N.A	3	N.A	YES	YES	N.A						3.00	3.18	
	87833-0831	87833-0841	87833-0851	2												
	87833-0832	N.A	N.A	3	N.A	YES	YES	N.A						N.A	2.92	
	87833-0861	N.A	N.A	2												
87833-0824	N.A	N.A	2	N.A	N.A	YES	YES	N.A	2.92							
87833-0825	N.A	N.A	3													
10	87832-1019	N.A	N.A	1	N.A	N.A	YES	YES	12.65	8.00	11.00	10.85	N.A	N.A	2.16	
	87833-1020	N.A	N.A	2												
	87833-1021	N.A	N.A	3	N.A	YES	YES	N.A						4.00	2.16	
	87833-1031	N.A	N.A	2												
	87833-1032	N.A	N.A	3	N.A	YES	YES	N.A						4.00	1.70	
	N.A	87833-1041	87833-1051	2												
87833-1024	N.A	N.A	2	N.A	N.A	YES	YES	N.A	2.92							
87833-1025	N.A	N.A	3													
12	87833-1219	N.A	N.A	1	N.A	N.A	YES	YES	14.65	10.00	13.00	12.85	N.A	N.A	2.16	
	87833-1220	N.A	N.A	2												
	87833-1221	N.A	N.A	3	N.A	N.A	YES	YES						N.A	3.18	
	87833-6020	N.A	N.A	2												
	87833-1231	N.A	N.A	2	N.A	YES	YES	N.A						5.00	2.16	
	87833-1232	N.A	N.A	3												
	87833-1224	N.A	N.A	2	N.A	N.A	YES	YES						N.A	2.92	
87833-1225	N.A	N.A	3													

PLATING OPTIONS:

- 1 - 0.05-0.13um/2-5uin GOLD IN CONTACT AREA AND 1.88um/75uin MIN. MATTE TIN IN SOLDER TAIL AREA OVER 1.27um/50uin MIN. NICKEL OVERALL.
- 2 - 0.38um/15uin MIN. GOLD IN CONTACT AREA AND 1.88um/75uin MIN. MATTE TIN IN SOLDER TAIL AREA OVER 1.27um/50uin MIN. NICKEL OVERALL.
- 3 - 0.76um/30uin MIN. GOLD IN CONTACT AREA AND 1.88um/75uin MIN. MATTE TIN IN SOLDER TAIL AREA OVER 1.27um/50uin MIN. NICKEL OVERALL.

SEE SHEET 2,4,6,7 EC NO: S2016-0454 DRWNG: GEMEARLY 2015/11/05 CHK'D: CGOH 2015/11/17 APPR: KHL IM 2015/11/18	REV A1	DESCRIPTION	QUALITY SYMBOLS	GENERAL TOLERANCES (UNLESS SPECIFIED)	DIMENSION STYLE	SCALE	DESIGN UNITS	THIRD ANGLE PROJECTION			
			$\nabla_A = 0$ $\nabla_C = 0$ $\nabla_P = 0$	mm INCH 4 PLACES ± --- ± --- 3 PLACES ± --- ± --- 2 PLACES ± 0.20 ± --- 1 PLACE ± --- ± --- 0 PLACE ± --- ± ---	MM ONLY	NTS	METRIC	DRAWN BY: GMENARLY DATE: 2015/09/29 CHECKED BY: CGOH DATE: 2015/10/30 APPROVED BY: KHL IM DATE: 2015/11/03	MILLIGRID 2MM PITCH, SMT R/A SHROUDED HEADER molex		
			ANGULAR ± 3 °	DRAFT WHERE APPLICABLE MUST REMAIN WITHIN DIMENSIONS	SEE TABLE	DOCUMENT NO. SD-87833-0001	SHEET NO. 5 OF 9				
			THIS DRAWING CONTAINS INFORMATION THAT IS PROPRIETARY TO MOLEX INCORPORATED AND SHOULD NOT BE USED WITHOUT WRITTEN PERMISSION								

14 TO 50 CIRCUITS

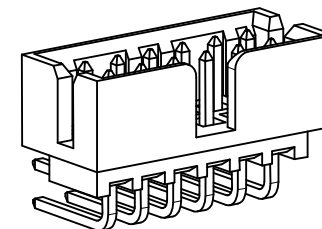
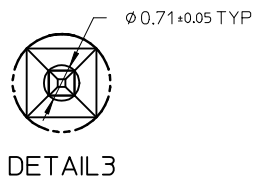
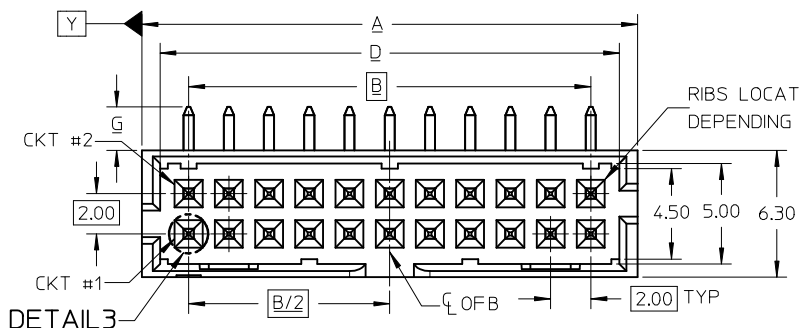

ISO VIEW OF HEADER WITH CENTER POLARIZATION AND DUAL SIDE SLOTS

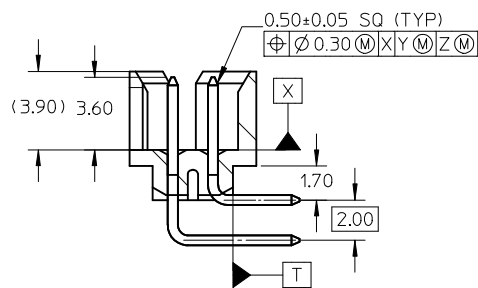
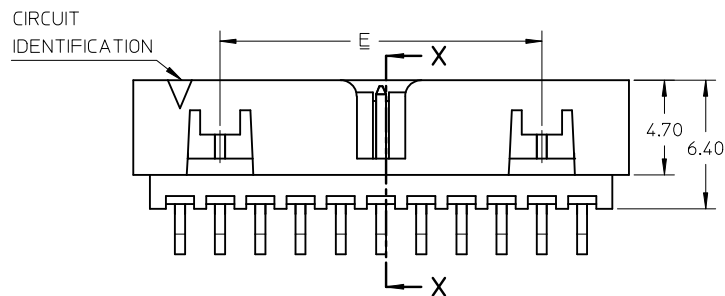

SECTION X-X

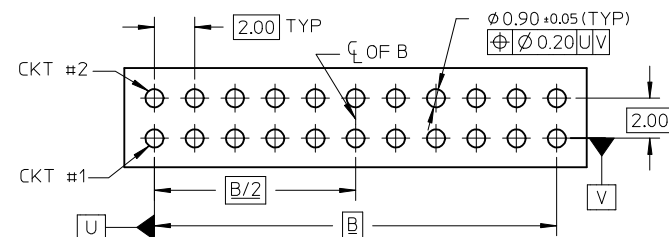
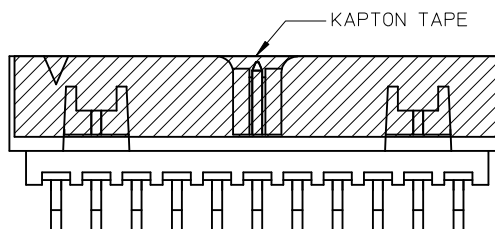
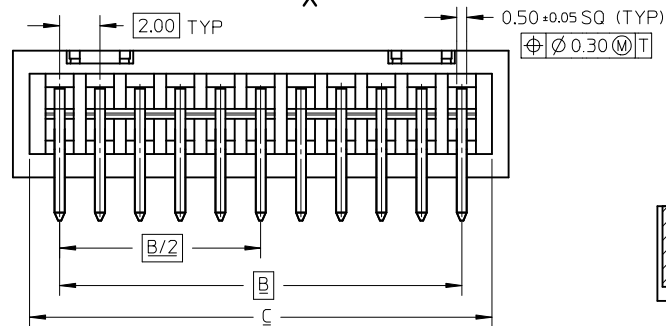

NOTES:

1. MATERIALS:
HOUSING: 30% GF, NYLON, UL94V-0, COLOR: BLACK
PIN: 0.50MM SQ PHOSPHOR BRONZE
2. FINISHES: REFER TO PLATING OPTIONS
3. PRODUCT SPECIFICATION: PS-87831-027
4. PACKAGING SPECIFICATION:
TUBE: PK-87831-001, TAPE AND REEL: PK-87831-300
5. MATES WITH: A. MOLEX CRIMP RECEPTACLE HOUSING: 51110 SERIES AND CRIMP TERMINAL: 50394 SERIES
B. MOLEX 2MM MILLIGRID DUAL ROW IDT: 87568 SERIES
C. MOLEX 2MM MILLIGRID DUAL ROW RECEPTACLE: 79107 (GOLD PLATED), 78787 (TIN PLATED)
6. FOR ILLUSTRATION PURPOSE, 22 CIRCUITS HEADER IS SHOWN

ADD NOTE 6 EC NO: S2016-0454 DRWN:GMENARLY 2015/11/05 CHKD:CGOH 2015/11/17 APPR:KHL IM 2015/11/18	QUALITY SYMBOLS $F_A=0$ $F_C=0$ $F_P=0$	GENERAL TOLERANCES (UNLESS SPECIFIED)		DIMENSION STYLE MM ONLY		SCALE NTS	DESIGN UNITS METRIC	THIRD ANGLE PROJECTION			
		mm	INCH	DRAWN BY	DATE	TITLE					
		4 PLACES ± --- ± ---	3 PLACES ± --- ± ---	2 PLACES ± 0.20 ± ---	1 PLACE ± --- ± ---	0 PLACE ± --- ± ---	GMENARLY	2015/09/29	MILLIGRID 2MM PITCH, SMT R/A SHROUDED HEADER molex		
		ANGULAR ± 3 °					CHECKED BY	DATE			
DRAFT WHERE APPLICABLE MUST REMAIN WITHIN DIMENSIONS					APPROVED BY KHL IM 2015/11/03		SEE TABLE		SD-87833-0001	6 OF 9	
MATERIAL NO.					THIS DRAWING CONTAINS INFORMATION THAT IS PROPRIETARY TO MOLEX INCORPORATED AND SHOULD NOT BE USED WITHOUT WRITTEN PERMISSION						

14 TO 24 CIRCUITS

CKT SIZE	ASSY P/N WITHOUT KAPTON IN TUBE	ASSY P/N WITH KAPTON IN TUBE	ASSY P/N WITH KAPTON IN T&R	PLATING OPTIONS	FRICTION LOCKS		DUAL SIDE SLOTS	CENTER POLARIZATION	DIMENSION						
					DUAL	CENTER			A	B	C	D	E	F	G (SOLDER TAIL)
14	87833-1419	N.A	N.A	1					16.65	12.00	15.00	14.85	8.00	N.A	2.16
	87833-1420	N.A	N.A	2	YES	N.A	YES	YES							
	87833-1421	N.A	N.A	3											
	87833-5320	N.A	N.A	2	YES	N.A	YES	YES							
	87833-5321	N.A	N.A	3											
87833-1436	N.A	N.A	3	YES	N.A	YES	YES							3.50	
16	87833-1619	N.A	N.A	1					18.65	14.00	17.00	16.85	10.00	N.A	2.16
	87833-1620	N.A	N.A	2	YES	N.A	YES	YES							
	87833-1621	N.A	N.A	3											
	87833-6120	N.A	87833-7120	2	YES	N.A	YES	YES							
18	87833-1819	N.A	N.A	1					20.65	16.00	19.00	18.85	12.00	N.A	2.16
	87833-1820	N.A	N.A	2	YES	N.A	YES	YES							
	87833-1821	N.A	N.A	3											
	87833-6220	N.A	N.A	2	YES	N.A	YES	YES							
20	87833-2019	N.A	N.A	1					22.65	18.00	21.00	20.85	14.00	N.A	2.16
	87833-2020	N.A	87833-7220	2	YES	N.A	YES	YES							
	87833-2021	N.A	N.A	3											
	87833-6520	N.A	N.A	2	YES	N.A	YES	YES							
	87833-6521	N.A	N.A	3											
	87833-2036	N.A	N.A	3	YES	N.A	YES	YES							
22	87833-2219	N.A	N.A	1					24.65	20.00	23.00	22.85	16.00	N.A	2.16
	87833-2220	N.A	N.A	2	YES	N.A	YES	YES							
	87833-2221	N.A	N.A	3											
24	87833-2419	N.A	N.A	1					26.65	22.00	25.00	24.85	18.00	N.A	2.16
	87833-2420	N.A	(A1) 87833-7020	2	YES	N.A	YES	YES							
	87833-2421	N.A	N.A	3											
	87833-2436	N.A	N.A	3	YES	N.A	YES	YES							
	87833-6920	N.A	N.A	2	YES	N.A	YES	YES							

PLATING OPTIONS:

- 1 - 0.05-0.13um/2-5uin GOLD IN CONTACT AREA AND 1.88um/75uin MIN. MATTE TIN IN SOLDER TAIL AREA OVER 1.27um/50uin MIN. NICKEL OVERALL.
- 2 - 0.38um/15uin MIN. GOLD IN CONTACT AREA AND 1.88um/75uin MIN. MATTE TIN IN SOLDER TAIL AREA OVER 1.27um/50uin MIN. NICKEL OVERALL.
- 3 - 0.76um/30uin MIN. GOLD IN CONTACT AREA AND 1.88um/75uin MIN. MATTE TIN IN SOLDER TAIL AREA OVER 1.27um/50uin MIN. NICKEL OVERALL.

ADD P/N 87833-7020
 EC NO: S2016-0454
 DRWN:GMENARLY 2015/11/05
 CHKD:CGOH 2015/11/17
 APPR:KHL IM 2015/11/18

QUALITY SYMBOLS
 $F_A=0$
 $F_G=0$
 $F_P=0$

GENERAL TOLERANCES (UNLESS SPECIFIED)	
mm	INCH
4 PLACES ± ---	± ---
3 PLACES ± ---	± ---
2 PLACES ± 0.20	± ---
1 PLACE ± ---	± ---
0 PLACE ± ---	± ---
ANGULAR ± 3 °	
DRAFT WHERE APPLICABLE MUST REMAIN WITHIN DIMENSIONS	

DIMENSION STYLE	
MM ONLY	
DRAWN BY	DATE
GMENARLY	2015/09/29
CHECKED BY	DATE
CGOH	2015/10/30
APPROVED BY	DATE
KHL IM	2015/11/03
MATERIAL NO.	
SEE TABLE	
SIZE	A3

SCALE	DESIGN UNITS	THIRD ANGLE PROJECTION
NTS	METRIC	
MILLIGRID 2MM PITCH, SMT R/A SHROUDED HEADER 		
DOCUMENT NO.		SHEET NO.
SD-87833-0001		7 OF 9
THIS DRAWING CONTAINS INFORMATION THAT IS PROPRIETARY TO MOLEX INCORPORATED AND SHOULD NOT BE USED WITHOUT WRITTEN PERMISSION		

26 TO 38 CIRCUITS

CTK SIZE	ASSY P/N WITHOUT KAPTON IN TUBE	ASSY P/N WITH KAPTON IN TUBE	ASSY P/N WITH KAPTON IN T&R	PLATING OPTIONS	FRICTION LOCKS		DUAL SIDE SLOTS	CENTER POLARIZATION	DIMENSION						
					DUAL	CENTER			A	B	C	D	E	F	G (SOLDER TAIL)
26	87833-2619	N.A	N.A	1											
	87833-2620	N.A	N.A	2											
	87833-2621	N.A	N.A	3	YES	N.A	YES	YES	28.65	24.00	27.00	26.85	20.00	N.A	2.16
	87833-2636	N.A	N.A	3	YES	N.A	YES	YES							3.50
28	87833-2819	N.A	N.A	1											
	87833-2820	N.A	N.A	2											
	87833-2821	N.A	N.A	3	YES	N.A	YES	YES	30.65	26.00	29.00	28.85	22.00	N.A	2.16
	87833-6620	N.A	N.A	2	YES	N.A	YES	YES							3.18
30	87832-3019	N.A	N.A	1											
	87833-3020	N.A	N.A	2											
	87833-3021	N.A	N.A	3	YES	N.A	YES	YES	32.65	28.00	31.00	30.85	24.00	N.A	2.16
	87833-6720	N.A	N.A	2											
	87833-6721	N.A	N.A	3	YES	N.A	YES	YES							3.18
	87833-3036	N.A	N.A	3	YES	N.A	YES	YES							3.50
32	87833-3219	N.A	N.A	1											
	87833-3220	N.A	N.A	2	YES	N.A	YES	YES	34.65	30.00	33.00	32.85	26.00	N.A	2.16
	87833-3221	N.A	N.A	3											
34	87833-3419	N.A	N.A	1											
	87833-3420	N.A	N.A	2	YES	N.A	YES	YES							
	87833-3421	N.A	N.A	3											
	87833-5420	N.A	N.A	2	YES	N.A	YES	YES	36.65	32.00	35.00	34.85	28.00	N.A	2.16
	87833-3424	N.A	N.A	2	N.A	N.A	YES	YES							3.18
36	87833-3619	N.A	N.A	1											
	87833-3620	N.A	N.A	2	YES	N.A	YES	YES	38.65	34.00	37.00	36.85	30.00	N.A	2.16
	87833-3621	N.A	N.A	3											
38	87833-3819	N.A	N.A	1											
	87833-3820	N.A	N.A	2	YES	N.A	YES	YES	40.65	36.00	39.00	38.85	32.00	N.A	2.16
	87833-3821	N.A	N.A	3											

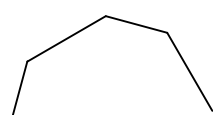

PLATING OPTIONS:

- 1 - 0.05-0.13um/2-5uin GOLD IN CONTACT AREA AND 1.88um/75uin MIN. MATTE TIN IN SOLDER TAIL AREA OVER 1.27um/50uin MIN. NICKEL OVERALL.
- 2 - 0.38um/15uin MIN. GOLD IN CONTACT AREA AND 1.88um/75uin MIN. MATTE TIN IN SOLDER TAIL AREA OVER 1.27um/50uin MIN. NICKEL OVERALL.
- 3 - 0.76um/30uin MIN. GOLD IN CONTACT AREA AND 1.88um/75uin MIN. MATTE TIN IN SOLDER TAIL AREA OVER 1.27um/50uin MIN. NICKEL OVERALL.

SEE SHEET 24.6.7 IEC NO: S2016-0454 DRWN:GMENARLY 2015/11/05 CH'KD:CGOH 2015/11/17 APPR:KHL IM 2015/11/18	QUALITY SYMBOLS	GENERAL TOLERANCES (UNLESS SPECIFIED)		DIMENSION STYLE	SCALE	DESIGN UNITS	THIRD ANGLE PROJECTION
	$F_{\Delta} = 0$ $F_{\square} = 0$ $F_{\nabla} = 0$	mm	INCH	MM ONLY	NTS	METRIC	
		4 PLACES ± --- ± ---		DRAWN BY	DATE	TITLE	
		3 PLACES ± --- ± ---		GMENARLY	2015/09/29	MILLIGRID 2MM PITCH, SMT R/A SHROUDED HEADER	
	2 PLACES ± 0.20 ± ---		CHECKED BY	DATE			
	1 PLACE ± --- ± ---		CGOH	2015/10/30			
	0 PLACE ± --- ± ---		APPROVED BY	DATE			
			KHL IM	2015/11/03			
			MATERIAL NO.	DOCUMENT NO.			
			SEE TABLE	SD-87833-0001			
			ANGULAR ± 3 °				
			DRAFT WHERE APPLICABLE MUST REMAIN WITHIN DIMENSIONS				
			SIZE	THIS DRAWING CONTAINS INFORMATION THAT IS PROPRIETARY TO MOLEX INCORPORATED AND SHOULD NOT BE USED WITHOUT WRITTEN PERMISSION			
			A3				

40 TO 50 CIRCUITS

CKT SIZE	ASSY P/N WITHOUT KAPTON IN TUBE	ASSY P/N WITH KAPTON IN TUBE	ASSY P/N WITH KAPTON IN T&R	PLATING OPTIONS	FRICTION LOCKS		DUAL SIDE SLOTS	CENTER POLARIZATION	DIMENSION							
					DUAL	CENTER			A	B	C	D	E	F	G (SOLDER TAIL)	
40	87833-4019	N.A	N.A	1												
	87833-4020	N.A	N.A	2	YES	N.A	YES	YES	42.65	38.00	41.00	40.85	34.00	N.A	2.16	
	87833-4021	N.A	N.A	3												
42	87833-4219	N.A	N.A	1												
	87833-4220	N.A	N.A	2	YES	N.A	YES	YES	44.65	40.00	43.00	42.85	36.00	N.A	2.16	
	87833-4221	N.A	N.A	3												
44	87833-4419	N.A	N.A	1												
	87833-4420	N.A	N.A	2	YES	N.A	YES	YES	46.65	42.00	45.00	44.85	38.00	N.A	2.16	
	87833-4421	N.A	N.A	3												
	87833-4424	N.A	N.A	2	N.A	N.A	YES	YES								
	87832-4425	N.A	N.A	3					2.92							
46	87833-4619	N.A	N.A	1												
	87833-4620	N.A	N.A	2	YES	N.A	YES	YES	48.65	44.00	47.00	46.85	40.00	N.A	2.16	
	87833-4621	N.A	N.A	3												
48	87833-4819	N.A	N.A	1												
	87833-4820	N.A	N.A	2	YES	N.A	YES	YES	50.65	46.00	49.00	48.85	42.00	N.A	2.16	
	87833-4821	N.A	N.A	3												
50	87833-5019	N.A	N.A	1												
	87833-5020	N.A	N.A	2	YES	N.A	YES	YES	52.65	48.00	51.00	50.85	44.00	N.A	0.15	
	87833-5021	N.A	N.A	3												

PLATING OPTIONS:

- 1 - 0.05-0.13um/2-5uin GOLD IN CONTACT AREA AND 1.88um/75uin MIN. MATTE TIN IN SOLDER TAIL AREA OVER 1.27um/50uin MIN. NICKEL OVERALL.
- 2 - 0.38um/15uin MIN. GOLD IN CONTACT AREA AND 1.88um/75uin MIN. MATTE TIN IN SOLDER TAIL AREA OVER 1.27um/50uin MIN. NICKEL OVERALL.
- 3 - 0.76um/30uin MIN. GOLD IN CONTACT AREA AND 1.88um/75uin MIN. MATTE TIN IN SOLDER TAIL AREA OVER 1.27um/50uin MIN. NICKEL OVERALL.

SEE SHEET 24.6.7 EC NO: S2016-0454 DRWN:GMENARLY 2015/11/05 CHKD:CGOH 2015/11/17 APPR:KHL IM 2015/11/18	DESCRIPTION QUALITY SYMBOLS $\nabla_A=0$ $\nabla_C=0$ $\nabla_P=0$	GENERAL TOLERANCES (UNLESS SPECIFIED)		DIMENSION STYLE	SCALE	DESIGN UNITS	THIRD ANGLE PROJECTION	
				MM ONLY	NTS	METRIC		
				mm	INCH	DRAWN BY	DATE	TITLE
				4 PLACES ± --- ± ---	GMENARLY	2015/09/29	MILLIGRID 2MM PITCH, SMT R/A SHROUDED HEADER	
		3 PLACES ± --- ± ---	CHECKED BY	DATE				
		2 PLACES ± 0.20 ± ---	CGOH	2015/10/30				
		1 PLACE ± --- ± ---	APPROVED BY	DATE				
		0 PLACE ± --- ± ---	KHL IM	2015/11/03				
		ANGULAR ± 3 °	MATERIAL NO.	DOCUMENT NO.		SHEET NO.		
		DRAFT WHERE APPLICABLE MUST REMAIN WITHIN DIMENSIONS	SEE TABLE	SD-87833-0001		9 OF 9		
			SIZE A3	THIS DRAWING CONTAINS INFORMATION THAT IS PROPRIETARY TO MOLEX INCORPORATED AND SHOULD NOT BE USED WITHOUT WRITTEN PERMISSION				