

- NOTES:
1. MATERIAL HOUSING: GLASS FILLED LCP (LIQUID CRYSTAL POLYMER), UL94V-0, COLOR-BLACK.
CONTACT: COPPER ALLOY.
 2. FINISH: SELECT GOLD - 0.76 MICROMETER/30 MICROINCH MINIMUM;
SELECT TIN - 3.81 MICROMETER/150 MICROINCH MINIMUM;
BOTH OVER NICKEL - 1.27 MICROMETER/50 MICROINCH MINIMUM.
 3. POWER TERMINALS LUBRICATED IN CONTACT AREA.
 4. PRODUCT SPECIFICATION: PS-45984-001.
 5. PACKAGING: TRAY PER PK-45984-001.
 6. SEE SHEET 5 FOR CKT IDENTIFICATION.
 7. PARTS ARE RoHS COMPLIANT.
 8. PEG HOLES ARE OPTIONAL - SEE SHEETS 3 & 4.
 9. MATES TO 1.577.062 CARD EDGE OR MOLEX P/N 45985-6***.

NO OF SIGNAL	MATERIAL NUMBER	DIM A	DIM P	PCB THK
12	45984-6111	47.5	4.50	3.18
16	45984-6121	50.0		
20	45984-6131	52.6		
24	45984-6141	55.1		
28	45984-6151	57.6		
32	45984-6161	60.2		
36	45984-6171	62.7	3.60	2.36
40	45984-6181	65.3		
12	45984-6112	47.5		
16	45984-6122	50.0		
20	45984-6132	52.6		
24	45984-6142	55.1		
28	45984-6152	57.6		
32	45984-6162	60.2		
36	45984-6172	62.7	2.90	1.57
40	45984-6182	65.3		
12	45984-6113	47.5		
16	45984-6123	50.0		
20	45984-6133	52.6		
24	45984-6143	55.1		
28	45984-6153	57.6		
32	45984-6163	60.2		
36	45984-6173	62.7		
40	45984-6183	65.3		

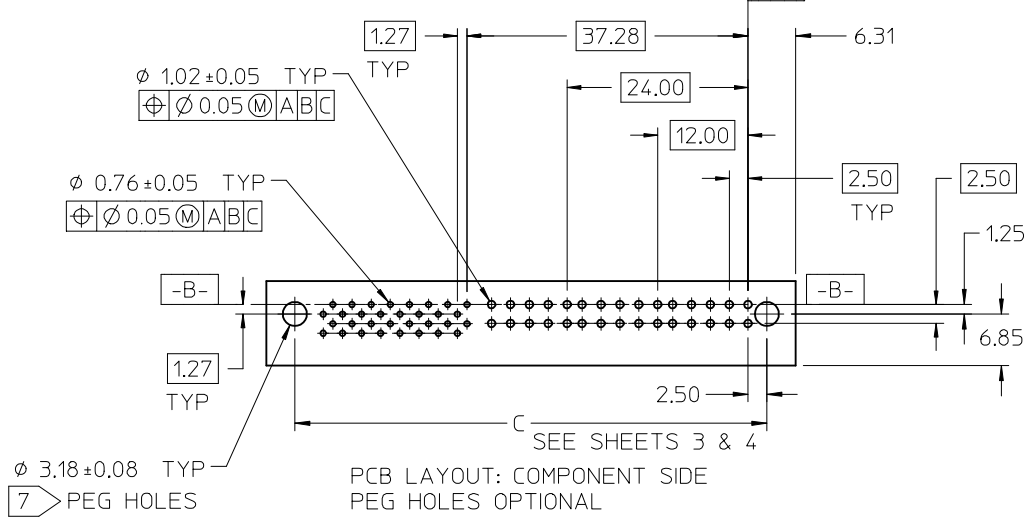

PCB LAYOUT: COMPONENT SIDE
PEG HOLES OPTIONAL

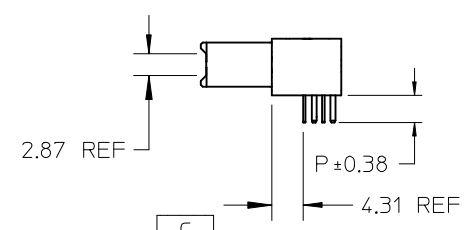
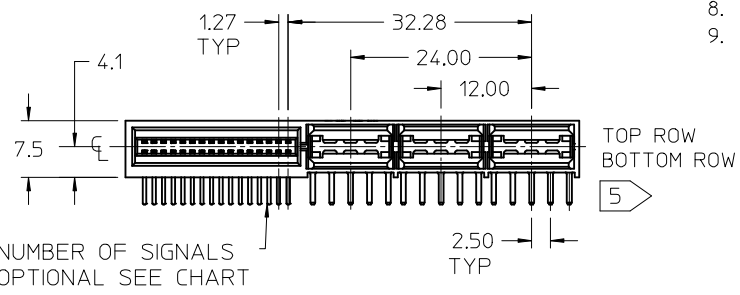
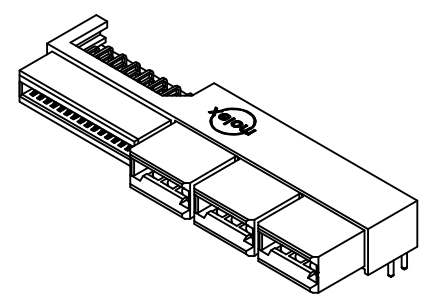

REVISE CARD EDGE EC NO: UCP2015-0571 DRWN: MBANDURA 2015/04/08 CHKD: APPR: APATEL 2015/04/20 DESCRIPTION	QUALITY SYMBOLS	GENERAL TOLERANCES (UNLESS SPECIFIED)		DIMENSION STYLE MM ONLY		SCALE 1:1	DESIGN UNITS METRIC	THIRD ANGLE PROJECTION	
	▽E=0	4 PLACES	± ---	± ---	DRAWN BY	DATE	TITLE LPH RECEPTACLE ASSEMBLY RT ANGLE 6 CIRCUIT POWER CONNECTOR		
	▽E=0	3 PLACES	± ---	± ---	SAMIEC	2005/05/13			
	▽E=0	2 PLACES	± 0.25	± ---	CHECKED BY	DATE	MOLEX MOLEX INCORPORATED		
▽E=0	1 PLACE	± 0.38	± ---	SAMIEC	2005/05/13				
		ANGULAR ±1/2°		APPROVED BY		DATE	DOCUMENT NO. SD-45984-600		
		DRAFT WHERE APPLICABLE MUST REMAIN WITHIN DIMENSIONS		MARGULIS		2005/05/13			
				MATERIAL NO. SEE CHART		THIS DRAWING CONTAINS INFORMATION THAT IS PROPRIETARY TO MOLEX INCORPORATED AND SHOULD NOT BE USED WITHOUT WRITTEN PERMISSION			

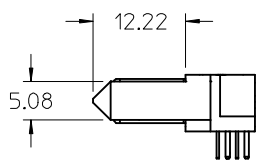
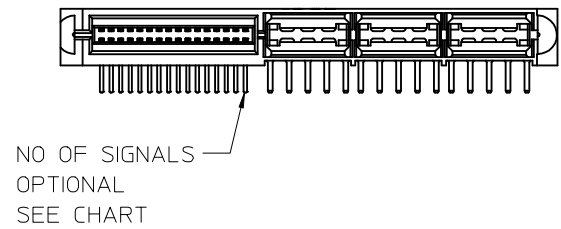
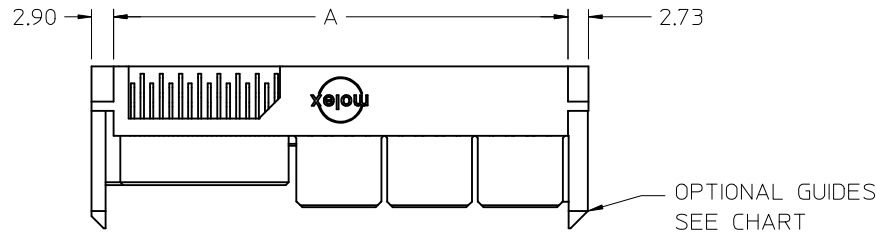

GUIDE POST OPTIONS

NO OF SIGNAL	MATERIAL NUMBER	DIM A	DIM P	PCB THK
12	45984-6211	47.5	4.50	3.18
16	45984-6221	50.0		
20	45984-6231	52.6		
24	45984-6241	55.1		
28	45984-6251	57.6		
32	45984-6261	60.2	3.60	2.36
36	45984-6271	62.7		
40	45984-6281	65.3		
12	45984-6212	47.5		
16	45984-6222	50.0		
20	45984-6232	52.6	2.90	1.57
24	45984-6242	55.1		
28	45984-6252	57.6		
32	45984-6262	60.2		
36	45984-6272	62.7		
40	45984-6282	65.3		
12	45984-6213	47.5	2.90	1.57
16	45984-6223	50.0		
20	45984-6233	52.6		
24	45984-6243	55.1		
28	45984-6253	57.6		
32	45984-6263	60.2	2.90	1.57
36	45984-6273	62.7		
40	45984-6283	65.3		

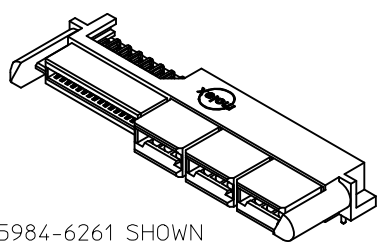

45984-6261 SHOWN
FOR REF ONLY
SEE CHART

SEE SHEET 1 EC NO: UCP2015-0571 DRWN:MBANDURA 2015/04/08 CHKD: APPR:APATEL 2015/04/20	DESCRIPTION REV	QUALITY SYMBOLS	GENERAL TOLERANCES (UNLESS SPECIFIED)		DIMENSION STYLE MM ONLY		SCALE 1:1	DESIGN UNITS METRIC	THIRD ANGLE PROJECTION																				
		$\nabla \text{E} = 0$ $\nabla \text{E} = 0$ $\nabla \text{E} = 0$	<table border="1"> <thead> <tr><th></th><th>mm</th><th>INCH</th></tr> </thead> <tbody> <tr><td>4 PLACES</td><td>± ---</td><td>± ---</td></tr> <tr><td>3 PLACES</td><td>± ---</td><td>± ---</td></tr> <tr><td>2 PLACES</td><td>± 0.25</td><td>± ---</td></tr> <tr><td>1 PLACE</td><td>± 0.38</td><td>± ---</td></tr> </tbody> </table>		mm	INCH	4 PLACES	± ---	± ---	3 PLACES	± ---	± ---	2 PLACES	± 0.25	± ---	1 PLACE	± 0.38	± ---	<table border="1"> <thead> <tr><th></th><th>mm</th><th>INCH</th></tr> </thead> <tbody> <tr><td>ANGULAR</td><td>± 1/2°</td><td></td></tr> </tbody> </table>		mm	INCH	ANGULAR	± 1/2°		DRAWN BY SAMIEC	DATE 2005/05/13	TITLE LPH RECEPTACLE ASSEMBLY RT ANGLE 6 CIRCUIT POWER CONNECTOR	
			mm	INCH																									
		4 PLACES	± ---	± ---																									
3 PLACES	± ---	± ---																											
2 PLACES	± 0.25	± ---																											
1 PLACE	± 0.38	± ---																											
	mm	INCH																											
ANGULAR	± 1/2°																												
DRAFT WHERE APPLICABLE MUST REMAIN WITHIN DIMENSIONS		CHECKED BY SAMIEC	DATE 2005/05/13	APPROVED BY MARGULIS		DATE 2005/05/13																							
				MATERIAL NO. SEE CHART		DOCUMENT NO. SD-45984-600		SHEET NO. 2 OF 5																					
				SIZE A		THIS DRAWING CONTAINS INFORMATION THAT IS PROPRIETARY TO MOLEX INCORPORATED AND SHOULD NOT BE USED WITHOUT WRITTEN PERMISSION																							

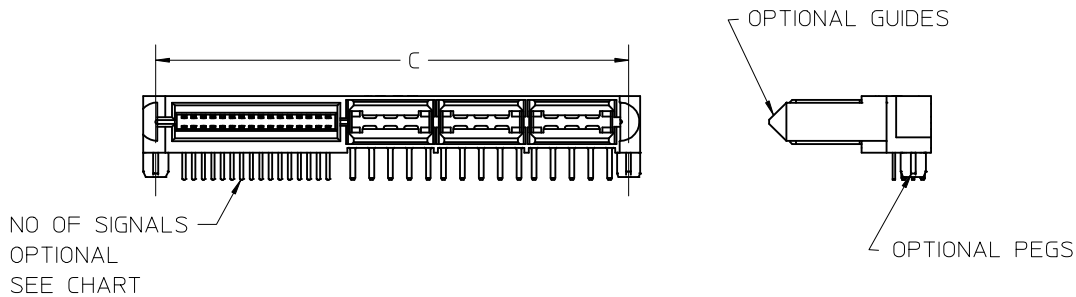
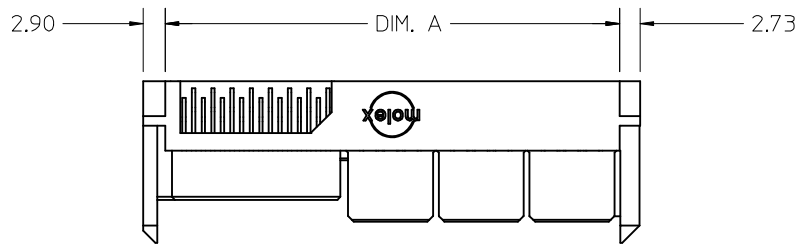

GUIDE POST & MOUNTING PEG OPTIONS

NO OF SIGNAL	MATERIAL NUMBER	DIM A	DIM C	DIM P	PCB THK
12	45984-6411	47.5	49.90	4.50	3.18
16	45984-6421	50.0	52.44		
20	45984-6431	52.6	54.98		
24	45984-6441	55.1	57.52		
28	45984-6451	57.6	60.06		
32	45984-6461	60.2	62.60	3.60	2.36
36	45984-6471	62.7	65.14		
40	45984-6481	65.3	67.68		
12	45984-6412	47.5	49.90		
16	45984-6422	50.0	52.44		
20	45984-6432	52.6	54.98	2.90	1.57
24	45984-6442	55.1	57.52		
28	45984-6452	57.6	60.06		
32	45984-6462	60.2	62.60		
36	45984-6472	62.7	65.14		
40	45984-6482	65.3	67.68	2.90	1.57
12	45984-6413	47.5	49.90		
16	45984-6423	50.0	52.44		
20	45984-6433	52.6	54.98		
24	45984-6443	55.1	57.52		
28	45984-6453	57.6	60.06		
32	45984-6463	60.2	62.60		
36	45984-6473	62.7	65.14		
40	45984-6483	65.3	67.68		

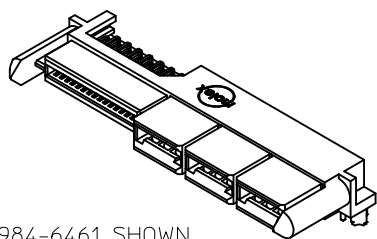

45984-6461 SHOWN
FOR REF ONLY
SEE CHART

SEE SHEET 1 EC NO: UCP2015-0571 DRWN:MBANDURA 2015/04/08 CHKD: APPR:APATEL 2015/04/20	QUALITY SYMBOLS $\nabla_F = 0$ $\nabla_E = 0$ $\nabla_P = 0$	GENERAL TOLERANCES (UNLESS SPECIFIED)		DIMENSION STYLE MM ONLY		SCALE 1:1	DESIGN UNITS METRIC	THIRD ANGLE PROJECTION		
			mm	INCH	DRAWN BY SAMIEC	DATE 2005/05/13	TITLE LPH RECEPTACLE ASSEMBLY RT ANGLE 6 CIRCUIT POWER CONNECTOR			
		4 PLACES	\pm ---	\pm ---	CHECKED BY SAMIEC	DATE 2005/05/13				
		3 PLACES	\pm ---	\pm ---	APPROVED BY MARGULIS	DATE 2005/05/13	MOLEX INCORPORATED DOCUMENT NO. SD-45984-600 SHEET NO. 4 OF 5			
2 PLACES	\pm 0.25	\pm ---	MATERIAL NO. SEE CHART							
1 PLACE	\pm 0.38	\pm ---	DRAFT WHERE APPLICABLE MUST REMAIN WITHIN DIMENSIONS		SIZE A		THIS DRAWING CONTAINS INFORMATION THAT IS PROPRIETARY TO MOLEX INCORPORATED AND SHOULD NOT BE USED WITHOUT WRITTEN PERMISSION			

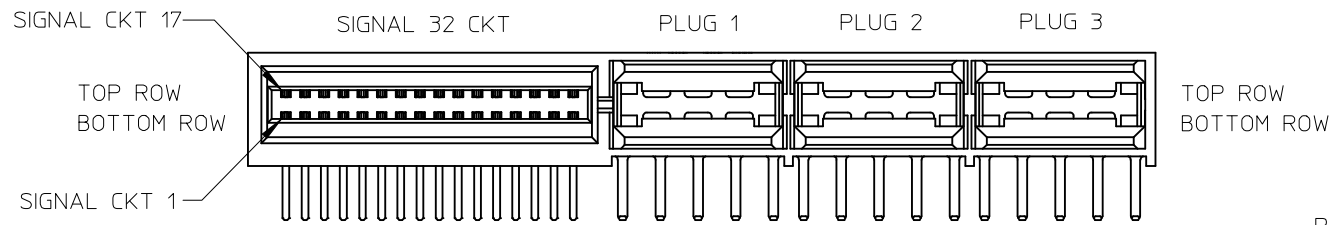

NO. OF SIGNAL	DIM. D
12	8.00
16	10.54
20	13.08
24	15.62
28	18.16
32	20.70
36	23.24
40	25.78

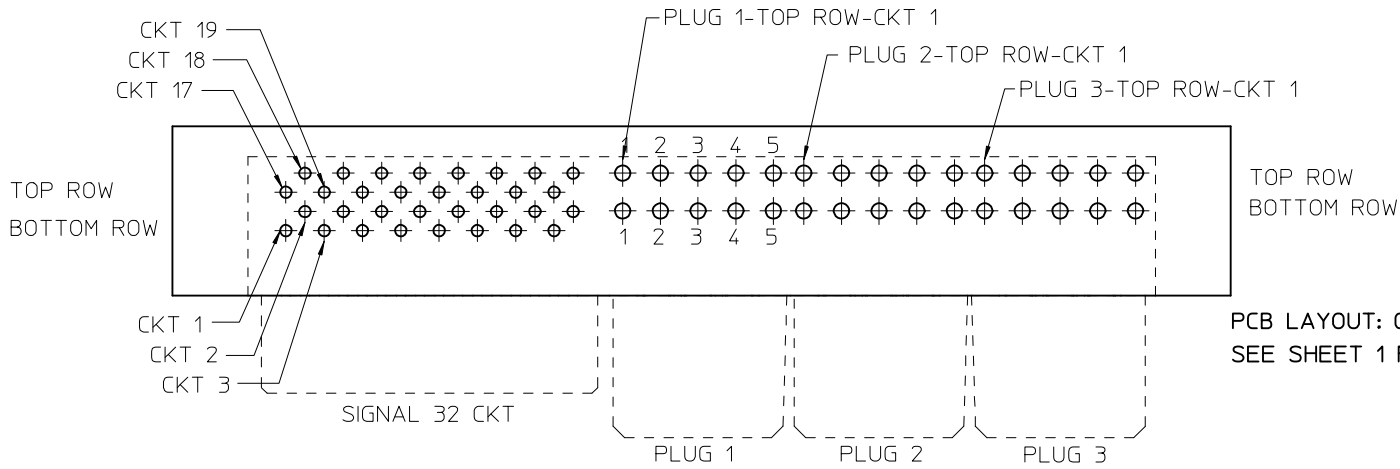
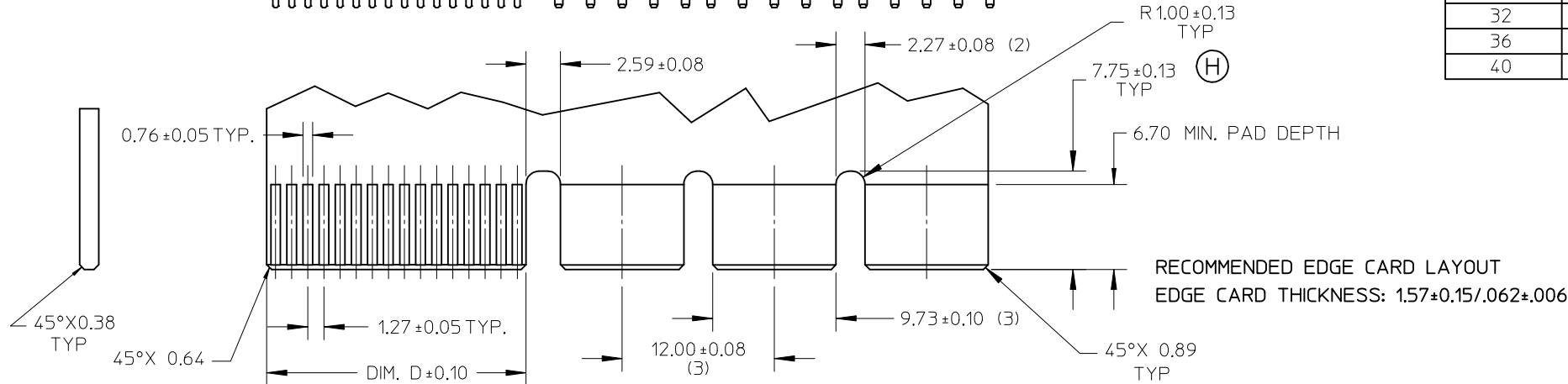

SEE SHEET 1 EC NO: UCP2015-0571 DRWN: MBANDURA 2015/04/08 CHKD: APPR: APATEL 2015/04/20	QUALITY SYMBOLS $\nabla = 0$ $\nabla = 0$ $\nabla = 0$	GENERAL TOLERANCES (UNLESS SPECIFIED) <table border="1"> <thead> <tr> <th></th> <th>mm</th> <th>INCH</th> </tr> </thead> <tbody> <tr> <td>4 PLACES</td> <td>± ---</td> <td>± ---</td> </tr> <tr> <td>3 PLACES</td> <td>± ---</td> <td>± ---</td> </tr> <tr> <td>2 PLACES</td> <td>± 0.25</td> <td>± ---</td> </tr> <tr> <td>1 PLACE</td> <td>± 0.38</td> <td>± ---</td> </tr> </tbody> </table>		mm	INCH	4 PLACES	± ---	± ---	3 PLACES	± ---	± ---	2 PLACES	± 0.25	± ---	1 PLACE	± 0.38	± ---	DIMENSION STYLE MM ONLY	SCALE 2:1	DESIGN UNITS METRIC	THIRD ANGLE PROJECTION
		mm	INCH																		
	4 PLACES	± ---	± ---																		
	3 PLACES	± ---	± ---																		
2 PLACES	± 0.25	± ---																			
1 PLACE	± 0.38	± ---																			
DRAWN BY SAMIEC	DATE 2005/05/13	TITLE LPH RECEPTACLE ASSEMBLY RT ANGLE 6 CIRCUIT POWER CONNECTOR																			
CHECKED BY SAMIEC	DATE 2005/05/13	MOLEX MOLEX INCORPORATED																			
APPROVED BY MARGULIS	DATE 2005/05/13	MATERIAL NO. SEE CHARTS	DOCUMENT NO. SD-45984-600	SHEET NO. 5 OF 5																	
DRAFT WHERE APPLICABLE MUST REMAIN WITHIN DIMENSIONS																					
THIS DRAWING CONTAINS INFORMATION THAT IS PROPRIETARY TO MOLEX INCORPORATED AND SHOULD NOT BE USED WITHOUT WRITTEN PERMISSION																					