

- SEE NOTE 10.
- NOTES:
1. MATERIAL HOUSING: GLASS FILLED LCP (LIQUID CRYSTAL POLYMER), 94V-0, COLOR-BLACK.  
CONTACT: COPPER ALLOY.
  2. FINISH: SELECT GOLD - .76 MICROMETERS/30 MICRONS MINIMUM CONTACT AREA.  
SELECT TIN - 3.81 MICROMETERS/150 MICRONS MINIMUM TAIL AREA.  
BOTH OVER NICKEL - 1.27 MICROMETERS/50 MICRONS MINIMUM.
  3. POWER TERMINALS ARE LUBRICATED IN CONTACT AREA.
  3. PRODUCT SPECIFICATION: PS-45984-001.
  4. PACKAGING: TRAY PER PK-45984-001.
  5. SEE SHEET 5 FOR CKT IDENTIFICATION.
  6. PARTS ARE RoHS COMPLIANT.
  7. PEG HOLES ARE OPTIONAL SEE SHEET 3 AND 4.
  8. MATES TO 1.57/0.062 CARD EDGE OR MOLEX P/N 45985-4\*\*\*\*.
  10. DATE CODE LOCATED APPROXIMATELY WHERE SHOWN.

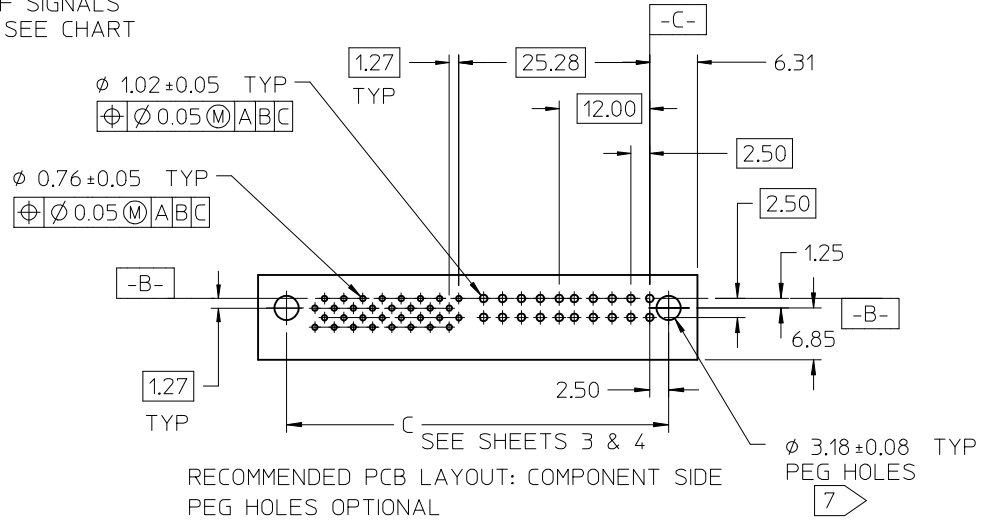

RECOMMENDED PCB LAYOUT: COMPONENT SIDE  
PEG HOLES OPTIONAL

NO OF SIGNAL	MATERIAL NUMBER	DIM A REF	DIM P	PCB THK
12	45984-4111	35.5	4.50	3.18
16	45984-4121	38.0		
20	45984-4131	40.6		
24	45984-4141	43.1		
28	45984-4151	45.6		
32	45984-4161	48.2		
36	45984-4171	50.7	3.60	2.36
40	45984-4181	53.3		
12	45984-4112	35.5		
16	45984-4122	38.0		
20	45984-4132	40.6		
24	45984-4142	43.1		
28	45984-4152	45.6	2.90	1.57
32	45984-4162	48.2		
36	45984-4172	50.7		
40	45984-4182	53.3		
12	45984-4113	35.5		
16	45984-4123	38.0		
20	45984-4133	40.6		
24	45984-4143	43.1		
28	45984-4153	45.6		
32	45984-4163	48.2		
36	45984-4173	50.7		
40	45984-4183	53.3		

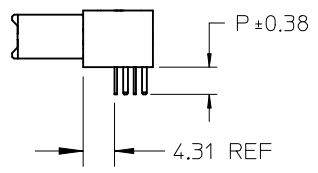
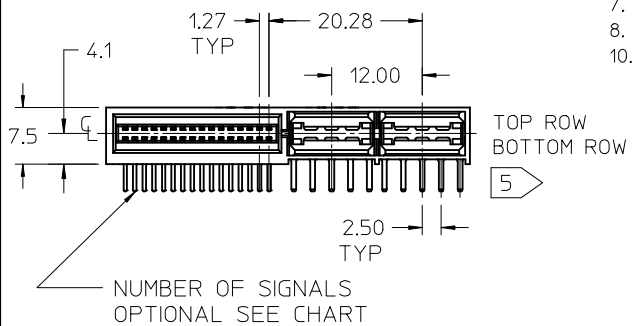
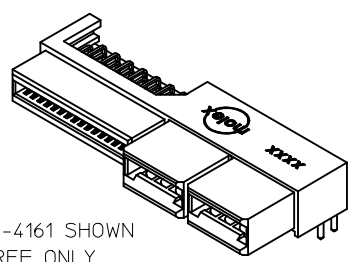

45984-4161 SHOWN  
FOR REF ONLY  
SEE CHART

REVISE CARD EDGE EC NO: UCP2015-0571 DRWN:MBANDURA 2015/04/08 CHKD: APPR:APATEL 2015/04/20	QUALITY SYMBOLS 	GENERAL TOLERANCES (UNLESS SPECIFIED)		DIMENSION STYLE <b>MM ONLY</b>		SCALE <b>1:1</b>	DESIGN UNITS <b>METRIC</b>	THIRD ANGLE PROJECTION		
			mm	INCH	DRAWN BY SAMIEC	DATE 2005/05/13	TITLE <b>LPH RECEPTACLE ASSEMBLY          RT ANGLE 4 CIRCUIT          POWER CONNECTOR</b>			
		4 PLACES ± ---	± ---	± ---	CHECKED BY SAMIEC	DATE 2005/05/13				
		3 PLACES ± ---	± ---	± ---	APPROVED BY MARGULIS	DATE 2005/05/13	<b>moLEX</b>		DOCUMENT NO. SD-45984-400	SHEET NO. 1 OF 5
2 PLACES ± 0.25	± 0.25	± ---	MATERIAL NO. <b>SEE CHART</b>		THIS DRAWING CONTAINS INFORMATION THAT IS PROPRIETARY TO MOLEX INCORPORATED AND SHOULD NOT BE USED WITHOUT WRITTEN PERMISSION					
1 PLACE ± 0.38	± 0.38	± ---	ANGULAR ± 1/2°							
0 PLACE ±	±	±	DRAFT WHERE APPLICABLE MUST REMAIN WITHIN DIMENSIONS							

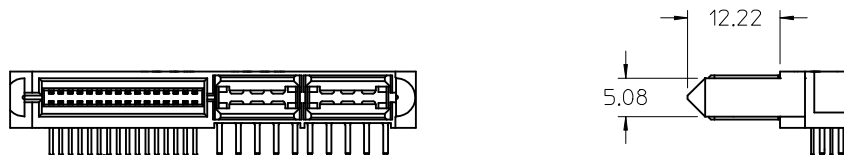
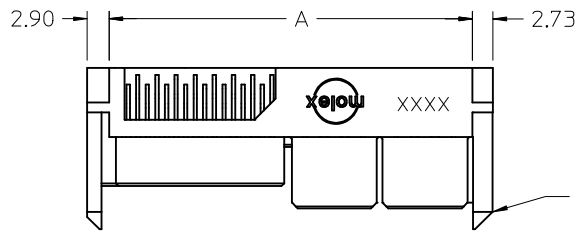

GUIDE POST OPTIONS

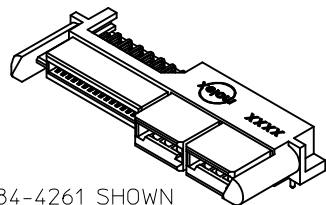

45984-4261 SHOWN  
FOR REF ONLY  
SEE CHART

NO OF SIGNAL	MATERIAL NUMBER	DIM A	DIM P	PCB THK
12	45984-4211	35.5	4.50	3.18
16	45984-4221	38.0		
20	45984-4231	40.6		
24	45984-4241	43.1		
28	45984-4251	45.6		
32	45984-4261	48.2	3.60	2.36
36	45984-4271	50.7		
40	45984-4281	53.3		
12	45984-4212	35.5		
16	45984-4222	38.0		
20	45984-4232	40.6	2.90	1.57
24	45984-4242	43.1		
28	45984-4252	45.6		
32	45984-4262	48.2		
36	45984-4272	50.7		
40	45984-4282	53.3	2.90	1.57
12	45984-4213	35.5		
16	45984-4223	38.0		
20	45984-4233	40.6		
24	45984-4243	43.1		
28	45984-4253	45.6		
32	45984-4263	48.2		
36	45984-4273	50.7		
40	45984-4283	53.3		

SEE SHEET 1 EC NO: UCP2015-0571 DRWN:MBANDURA 2015/04/08 CHKD: APPR:APATEL 2015/04/20	QUALITY SYMBOLS 	GENERAL TOLERANCES (UNLESS SPECIFIED)		DIMENSION STYLE <b>MM ONLY</b>		SCALE <b>1:1</b>	DESIGN UNITS <b>METRIC</b>	THIRD ANGLE PROJECTION		
			mm	INCH	DRAWN BY SAMIEC	DATE 2005/05/13	TITLE <b>LPH RECEPTACLE ASSEMBLY          RT ANGLE 4 CIRCUIT          POWER CONNECTOR</b>			
		4 PLACES	± ---	± ---	CHECKED BY SAMIEC	DATE 2005/05/13				
		3 PLACES	± ---	± ---	APPROVED BY MARGULIS	DATE 2005/05/13	<b>molex</b> DOCUMENT NO. SD-45984-400 SHEET NO. 2 OF 5			
2 PLACES	± 0.25	± ---	MATERIAL NO. <b>SEE CHART</b>							
1 PLACE	± 0.38	± ---	ANGULAR ± 1/2°		THIS DRAWING CONTAINS INFORMATION THAT IS PROPRIETARY TO MOLEX INCORPORATED AND SHOULD NOT BE USED WITHOUT WRITTEN PERMISSION					
0 PLACE	±	±	DRAFT WHERE APPLICABLE MUST REMAIN WITHIN DIMENSIONS							

6

5

4

3

2

1

NO OF SIGNAL	MATERIAL NUMBER	DIM A	DIM C	DIM P	PCB THK
12	45984-4311	35.5	37.90	4.50	3.18
16	45984-4321	38.0	40.44		
20	45984-4331	40.6	42.98		
24	45984-4341	43.1	45.52		
28	45984-4351	45.6	48.06		
32	45984-4361	48.2	50.60		
36	45984-4371	50.7	53.14	3.60	2.36
40	45984-4381	53.3	55.68		
12	45984-4312	35.5	37.90		
16	45984-4322	38.0	40.44		
20	45984-4332	40.6	42.98		
24	45984-4342	43.1	45.52		
28	45984-4352	45.6	48.06		
32	45984-4362	48.2	50.60		
36	45984-4372	50.7	53.14	2.90	1.57
40	45984-4382	53.3	55.68		
12	45984-4313	35.5	37.90		
16	45984-4323	38.0	40.44		
20	45984-4333	40.6	42.98		
24	45984-4343	43.1	45.52		
28	45984-4353	45.6	48.06		
32	45984-4363	48.2	50.60		
36	45984-4373	50.7	53.14	40	55.68
40	45984-4383	53.3	55.68		

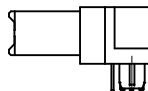
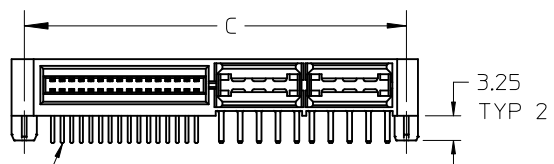
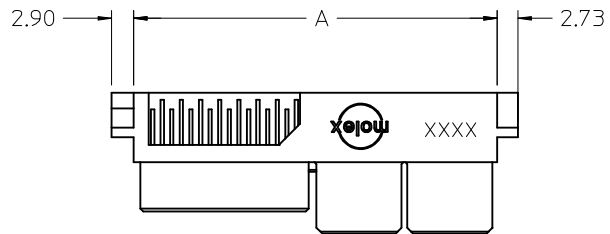

NO OF SIGNALS  
OPTIONAL  
SEE CHART

OPTIONAL PEGS

MOUNTING PEG OPTIONS

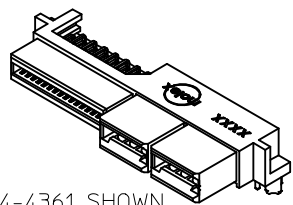

45984-4361 SHOWN  
FOR REF ONLY  
SEE CHART

SEE SHEET 1 EC NO: UCP2015-0571 DRWN:MBANDURA 2015/04/08 CHKD: APPR:APATEL 2015/04/20 REV DESCRIPTION	QUALITY SYMBOLS	GENERAL TOLERANCES (UNLESS SPECIFIED)	DIMENSION STYLE MM ONLY		SCALE 1:1	DESIGN UNITS METRIC	THIRD ANGLE PROJECTION																														
	$\nabla = 0$ $\nabla = 0$ $\nabla = 0$	<table border="1"> <thead> <tr> <th></th> <th>mm</th> <th>INCH</th> </tr> </thead> <tbody> <tr><td>4 PLACES</td><td><math>\pm</math> ---</td><td><math>\pm</math> ---</td></tr> <tr><td>3 PLACES</td><td><math>\pm</math> ---</td><td><math>\pm</math> ---</td></tr> <tr><td>2 PLACES</td><td><math>\pm 0.25</math></td><td><math>\pm</math> ---</td></tr> <tr><td>1 PLACE</td><td><math>\pm 0.38</math></td><td><math>\pm</math> ---</td></tr> <tr><td>0 PLACE</td><td><math>\pm</math></td><td><math>\pm</math></td></tr> </tbody> </table>		mm	INCH	4 PLACES	$\pm$ ---	$\pm$ ---	3 PLACES	$\pm$ ---	$\pm$ ---	2 PLACES	$\pm 0.25$	$\pm$ ---	1 PLACE	$\pm 0.38$	$\pm$ ---	0 PLACE	$\pm$	$\pm$	<table border="1"> <thead> <tr> <th>DRAWN BY</th> <th>DATE</th> </tr> </thead> <tbody> <tr><td>SAMIEC</td><td>2005/05/13</td></tr> <tr> <th>CHECKED BY</th> <th>DATE</th> </tr> <tr><td>SAMIEC</td><td>2005/05/13</td></tr> <tr> <th>APPROVED BY</th> <th>DATE</th> </tr> <tr><td>MARGULIS</td><td>2005/05/13</td></tr> </tbody> </table>	DRAWN BY	DATE	SAMIEC	2005/05/13	CHECKED BY	DATE	SAMIEC	2005/05/13	APPROVED BY	DATE	MARGULIS	2005/05/13	TITLE LPH RECEPTACLE ASSEMBLY RT ANGLE 4 CIRCUIT POWER CONNECTOR			
		mm	INCH																																		
	4 PLACES	$\pm$ ---	$\pm$ ---																																		
3 PLACES	$\pm$ ---	$\pm$ ---																																			
2 PLACES	$\pm 0.25$	$\pm$ ---																																			
1 PLACE	$\pm 0.38$	$\pm$ ---																																			
0 PLACE	$\pm$	$\pm$																																			
DRAWN BY	DATE																																				
SAMIEC	2005/05/13																																				
CHECKED BY	DATE																																				
SAMIEC	2005/05/13																																				
APPROVED BY	DATE																																				
MARGULIS	2005/05/13																																				
ANGULAR $\pm 1/2^\circ$ DRAFT WHERE APPLICABLE MUST REMAIN WITHIN DIMENSIONS	MATERIAL NO.	SEE CHART		DOCUMENT NO. SD-45984-400	SHEET NO. 3 OF 5																																
SIZE A THIS DRAWING CONTAINS INFORMATION THAT IS PROPRIETARY TO MOLEX INCORPORATED AND SHOULD NOT BE USED WITHOUT WRITTEN PERMISSION																																					

5

4

3

2

1

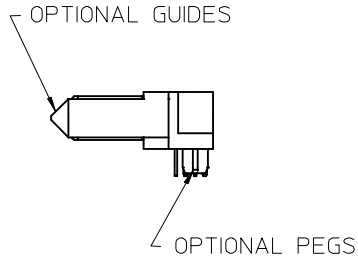
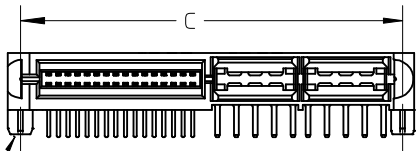
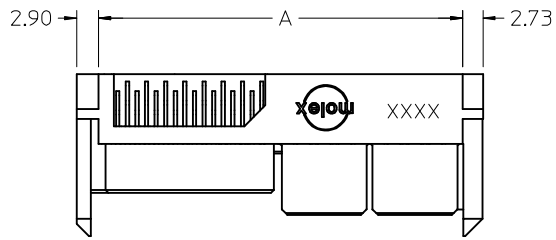

NO OF SIGNALS  
OPTIONAL  
SEE CHART

GUIDE POST & MOUNTING PEG OPTIONS

NO OF SIGNAL	MATERIAL NUMBER	DIM A	DIM C	DIM P	PCB THK
12	45984-4411	35.5	37.90	4.50	3.18
16	45984-4421	38.0	40.44		
20	45984-4431	40.6	42.98		
24	45984-4441	43.1	45.52		
28	45984-4451	45.6	48.06		
32	45984-4461	48.2	50.60		
36	45984-4471	50.7	53.14		
40	45984-4481	53.3	55.68		
12	45984-4412	35.5	37.90	3.60	2.36
16	45984-4422	38.0	40.44		
20	45984-4432	40.6	42.98		
24	45984-4442	43.1	45.52		
28	45984-4452	45.6	48.06		
32	45984-4462	48.2	50.60		
36	45984-4472	50.7	53.14		
40	45984-4482	53.3	55.68		
12	45984-4413	35.5	37.90	2.90	1.57
16	45984-4423	38.0	40.44		
20	45984-4433	40.6	42.98		
24	45984-4443	43.1	45.52		
28	45984-4453	45.6	48.06		
32	45984-4463	48.2	50.60		
36	45984-4473	50.7	53.14		
40	45984-4483	53.3	55.68		

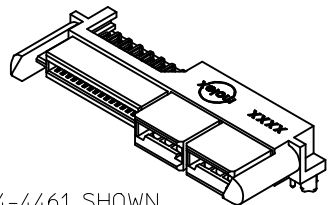

45984-4461 SHOWN  
FOR REF ONLY  
SEE CHART

SEE SHEET 1 EC NO: UCP2015-0571 DRWN:MBANDURA 2015/04/08 CHKD: APPR:APATEL 2015/04/20	QUALITY SYMBOLS	GENERAL TOLERANCES (UNLESS SPECIFIED)		DIMENSION STYLE MM ONLY		SCALE 1:1	DESIGN UNITS METRIC	THIRD ANGLE PROJECTION		
	$\nabla_A = 0$ $\nabla_E = 0$ $\nabla_F = 0$	4 PLACES	mm	INCH	DRAWN BY	DATE	TITLE LPH RECEPTACLE ASSEMBLY RT ANGLE 4 CIRCUIT POWER CONNECTOR			
		3 PLACES	± ---	± ---	SAMIEC	2005/05/13				
		2 PLACES	± 0.25	± ---	SAMIEC	2005/05/13	DOCUMENT NO. SD-45984-400			
	1 PLACE	± 0.38	± ---	MARGULIS	2005/05/13					
	0 PLACE	±	±	MATERIAL NO.		SHEET NO. 4 OF 5				
		ANGULAR ±1/2°			SEE CHART					
		DRAFT WHERE APPLICABLE MUST REMAIN WITHIN DIMENSIONS			SIZE A	THIS DRAWING CONTAINS INFORMATION THAT IS PROPRIETARY TO MOLEX INCORPORATED AND SHOULD NOT BE USED WITHOUT WRITTEN PERMISSION				

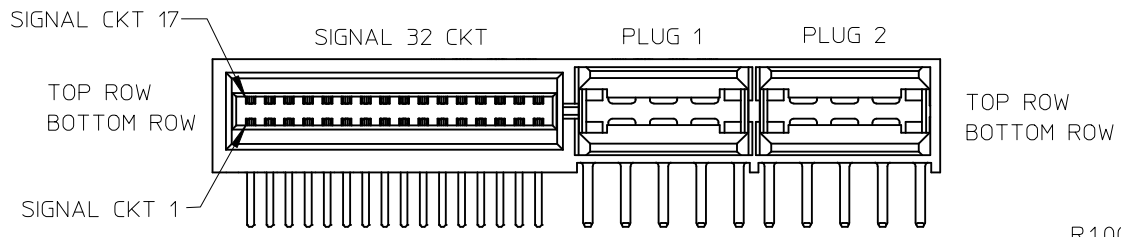

NO. OF SIGNAL	DIM. D
12	8.00
16	10.54
20	13.08
24	15.62
28	18.16
32	20.70
36	23.24
40	25.78

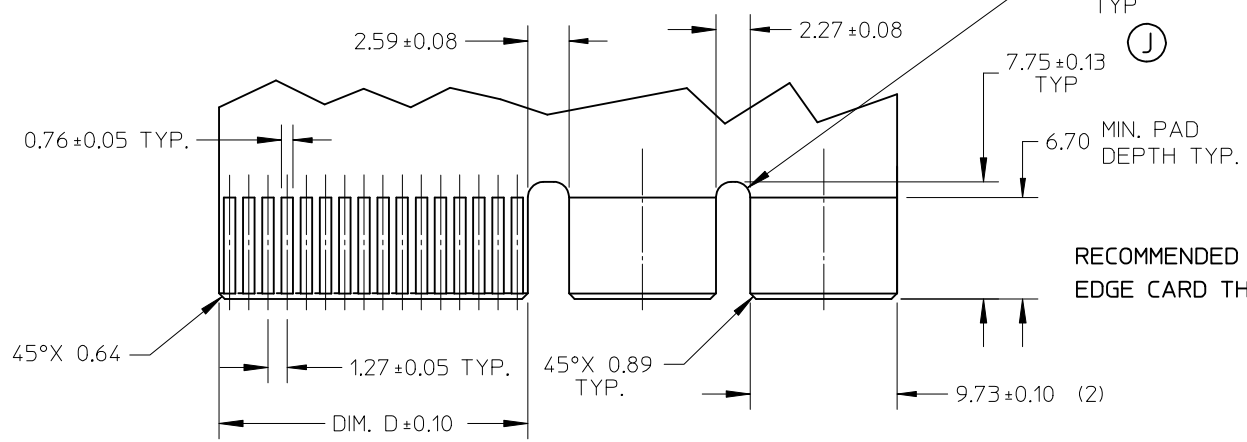

RECOMMENDED EDGE CARD LAYOUT  
EDGE CARD THICKNESS: 1.57±0.15/.062±.006

CIRCUIT IDENTIFICATION

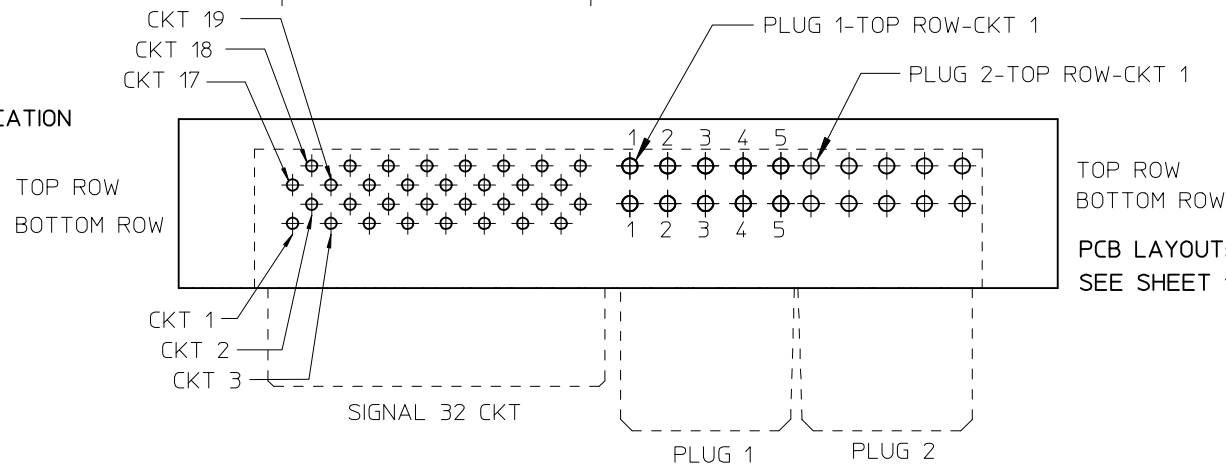

PCB LAYOUT: COMPONENT SIDE  
SEE SHEET 1 FOR DIMENSIONS

SEE SHEET 1 EC NO: UCP2015-0571 DRWN:MBANDURA 2015/04/08 CHKD: APPR:APATEL 2015/04/20	QUALITY SYMBOLS 	GENERAL TOLERANCES (UNLESS SPECIFIED)		DIMENSION STYLE MM ONLY		SCALE 2:1	DESIGN UNITS METRIC	THIRD ANGLE PROJECTION		
			mm	INCH	DRAWN BY SAMIEC	DATE 2005/05/13	TITLE LPH RECEPTACLE ASSEMBLY RT ANGLE 4 CIRCUIT POWER CONNECTOR			
		4 PLACES	± ---	± ---	CHECKED BY SAMIEC	DATE 2005/05/13				
		3 PLACES	± ---	± ---	APPROVED BY MARGULIS	DATE 2005/05/13				
		2 PLACES	± 0.25	± ---	MATERIAL NO.	DOCUMENT NO. SD-45984-400				
1 PLACE	± 0.38	± ---	SEE CHART							
0 PLACE	±	±	DRAFT WHERE APPLICABLE MUST REMAIN WITHIN DIMENSIONS		THIS DRAWING CONTAINS INFORMATION THAT IS PROPRIETARY TO MOLEX INCORPORATED AND SHOULD NOT BE USED WITHOUT WRITTEN PERMISSION					